

CERJAK[®]KG



C Line

C Line DZ

KATALOG

KARDANSKE GREDI

C Line



C Line



C Line DZ

Katalog ali dele kataloga ni dovoljeno razmnoževati ali kopirati brez predhodnega dovoljenja podjetja Cerjak d.o.o. Vsi podatki tega kataloga nadomestijo podatke iz predhodnih publikacij. Posledično bi lahko bili podatki iz predhodnih publikacij neveljavni.

Katalog smo pripravili z veliko pozornosti in natančnosti, vendar ne nosimo odgovornosti za tipografske napake in nepopolne podatke. Pridružujemo si pravico do spremembe specifikacij in tehničnih podatkov brez predhodnega opozorila.

	STRAN
UVOD	5
KARDANSKE GREDI	17
ŠIROKOKOTNE KARDANSKE GREDI	57
REZERVNI DELI KARDANSKE GREDI	86
REZERVNI DELI ŠIROKOKOTNE KARDANSKE GREDI	133





Spoštovani poslovni partnerji,

Spoštovani kupci,

Cerjak d.o.o. smo družinsko podjetje z dolgoletno tradicijo – kardanske gredi proizvajamo že od leta 1981. Z inovativnimi rešitvami, ki so standardno vključene v program kardanskih gredi C Line, Vam želimo ponuditi nekaj več in Vam s tem izboljšati uporabniško izkušnjo.

Hkrati proizvajalcem mehanizacije nudimo podporo pri razvoji novih strojev in namensko izdelavo vgradnih komponent ter kardanskih gredi.

Zagovarjamo kakovosten izdelek, saj se zavedamo pomena kakovosti izdelka za vsakega izmed nas. Kvalitetne komponente nam dobavljajo dolgoletni in preverjeni Evropski dobavitelji. Naše kardanske gredi so izdelane v skladu z vsemi varnostnimi regulativami in smernicami ter označeni s **CE** oznako. Sistem kakovosti podjetja izvajamo v skladu s standardom ISO 9001:2015.

V podjetju se zavedamo, da je razvoj stalnica. Zato bomo v prihodnosti v svoj prodajni program dodali nove in izboljšane izdelke. Razvoj usmerjamo v digitalizacijo kardanskih gredi, da Vam lahko ponudimo rešitve, ki Vam bodo še izboljšale uporabniško izkušnjo in hkrati zagotovile natančnejši pregled nad delovanjem le-teh.

Poslovni partnerji in kupci, hvala Vam za izkazano zaupanje in dolgoročna poslovna partnerstva. Hvala tudi vsem, ki ste interes in željo po sodelovanju že pokazali. Verjamem, da se boste odločili prav.

Kardanske gredi **CERJAK**[®] - prava odločitev!

Matija Cerjak,
komercialni direktor

SEDEM PREDNOSTI C LINE KARDANSKIH GREDI



C Line kardanske gredi se že na prvi pogled prepoznavne po patentiranem priključnem mehanizmu C Line in fleksibilni zaščitni kapi. Kardanske gredi odlikuje prijaznost do uporabnika, kompaktnost in privlačna oblika. Vse naše kardanski gredi zadostujejo zahtevam CE in so izdelane iz evropskih komponent.

V prodajnem programu ponujamo standardne in širokokotne kardanske gredi. Glede na potrebe uporabnikov so na voljo različne velikosti, dolžine in varnostni elementi (sklopke).

PATENTIRAN PRIKLJUČNI MEHANIZEM C LINE

Naša patentirana priključna vilica C Line je rezultat lastnega znanja in razvojne naravnosti. Uporabniku omogoča enostaven priklop in odklop kardanske gredi. Ohišje je ergonomsko oblikovano in kompaktno ter tako uporabniku nudi več udobja pri delu. Tudi za varnost smo poskrbeli, saj se uporabnik ne more zaplesti v štrleče dele priključne vilice, prav tako pa je pri samem delu prisotne manj umazanije in težav povezanih s tem.

ENOSTAVNO VZDRŽEVANJE

Naše kardanske gredi omogočajo uporabnikom enostavno vzdrževanje. Mazalke na standardnih križih so postavljene pod kotom, tako da uporabniki lažje dostopajo do njih. Lažji dostop je omogočen tudi zaradi fleksibilne zaščitne kape. Pri križih za širokokotne kardane smo upoštevali želje uporabnikov in mazalke postavili v ležaje križa. Druga novost, ki smo jo uvedli pri širokokotnih kardanskih gredeh C Line DZ je mazanje v liniji – s tem želimo uporabnikom dodatno olajšati vzdrževanje in podaljšanje življenjske dobe kardanskega zgloba.

NAREJENO V EU

Kvaliteta izdelkov je za nas in naše kupce bistvenega pomena. Zato so v naših izdelkih uporabljamo komponente evropskega porekla. Prav tako izvajamo konstantno kontrolo vhodnih materialov in kontrolo kakovosti končnih izdelkov. V našem podjetju delujemo po standardu ISO 9001 že od leta 2008.

VARNOST UPORABNIKOV

V podjetju se zavedamo, da je varnost uporabnikov na prvem mestu. Naše kardanske gredi zato ustrezajo vsem zakonsko določenim predpisom, direktivam in standardom o varnosti strojev v Evropski uniji. Ključnega pomena za zagotovitev varnosti je celovit pristop že v fazi razvoja celotnega izdelka.

FLEKSIBILNA ZAŠČITNA KAPA

Posebej za uporabnike smo oblikovali zaščitno kapo, ki je fleksibilna in omogoča lažje rokovanje med postopkom priklopljanja in odklopljanja kardanske gredi na traktor ali gnani stroj. V prostorsko omejenem delu kardanskega priklopa na gred, fleksibilna kapa predstavlja dodatno udobje uporabniku, saj zaradi nje lažje rokuje s kardansko gredjo.

PATENTIRANA STRIŽNA SKLOPKA (ST)

Naša patentirana strižna sklopka (ST) se ponaša z ergonomično in kompaktnjšo obliko. Njena posebnost je v simetričnosti, kar vpliva na zmanjšanje tresljajev zaradi ekscentričnih mas. Kardansko gred se lahko uporabi na drugem stroju saj je možnih več različni nastavitvev navora na eni sklopki. Menjava varnostnega elementa je poenostavljena zaradi oblike utora matice, kateri preprečuje vrtenje matice pri vijačenju - za menjavo je potreben samo en ključ.

VZDRŽEVANJE TORNE SKLOPKE (TS)

Na sklopki se nahajajo štiri izvrtine, ki omogočajo razbremenitev torne površine pred sezono. Navor med tem ostane nastavljen – po razbremenitvi sklopke ga ni potrebno ponovno nastaviti. Zaradi oblike vilice je nastavev lažja in bolj ergonomična. Oblika vilice zadrži vijak med nastavljanjem ter omogoča, da se nastavev izvede zgolj z 1 ključem namesto z dvema.



OZNAKE

Kardanska gred C Line 4 VS 900Nm kk910 (1140) 1 3/4"z6; 1 3/8"z6

- 1. Osnovni naziv
- 2. Oznaka prodajnega programa in velikosti
- 3. Vrsta kardanske gredi glede na varnostni element
- 4. Nazivni moment varnostnega elementa
- 5. Dolžina kardanske gredi med vrtilščema (križ-križ) v mm^(a)
- 6. Dolžina kardanske gredi (konec-konec) v mm^(b)
- 7. Profil priključnega mesta na strani pogonskega agregata^(c)
- 8. Profil priključnega mesta na strani delovnega stroja^(d)

Opomba:

- (a) Dolžina kardanske gredi med vrtilščema (križ-križ) v mm, v stisnjem stanju zaokrožena na 10 mm.
- (b) Dolžina celotne kardanske gredi stisnjem stanju zaokrožena navzgor za 10 mm.
- (c) Profil priključnega mesta na strani pogonskega agregata se ne piše, če je 1 3/8"z6 na obeh priključnih mestih.
- (d) Profil priključnega mesta na strani priključnega stroja se ne piše, če je 1 3/8"z6 na obeh priključnih mestih.

Križ C Line 4 27x74,6

- 1. Osnovni naziv
- 2. Oznaka prodajnega programa in velikosti
- 3. Premer ležajne izvrtine (mm)
- 4. Dolžina križa brez vskočnikov (mm)

Sklopka C Line 4 VS 900Nm 1 3/8"z6

- 1. Osnovni naziv
- 2. Oznaka prodajnega programa in velikost
- 3. Vrsta sklopke glede na varnostni element
- 4. Maksimalni moment, ki ga prenaša varnostni element
- 5. Profil priključnega mesta

Kardanski zglob C Line 4 TS (800Nm) TN 1 3/8"z6

- 1. Osnovni naziv
- 2. Oznaka prodajnega programa in velikost
- 3. Vrsta kardanskega zgloba glede na varnostni element
- 4. Maksimalni moment, ki ga prenaša varnostni element
- 5. Oblika vilice cevne glede na mesto vgradnje (TN - notranja ali TZ - zunanja)
- 6. Profil priključnega mesta

Vilica priključna C Line 4 DZ SNM 1 3/8"z6

- 1. Osnovni naziv
- 2. Oznaka prodajnega programa in velikost
- 3. Vrsta priključne vilice
- 4. Vrsta načina izvedbe priključnega mesta (velja samo za SNM)
- 5. Profil priključnega mesta

Vilica cevna C Line 4 TZ

- 1. Osnovni naziv
- 2. Oznaka prodajnega programa in velikost
- 3. Oblika vilice cevne glede na mesto vgradnje (TN - notranja ali TZ - zunanja)

LEGENDA

OBLIKA IN VELIKOST CEVI KARDANSKE GREDI



NAZIVNA MOČ, KI JO LAHKO PRENAŠA KARDANSKA GRED



TIP VARNOSTNEGA ELEMENTA, SMER DELOVANJA TER NAZIVNI MOMENT, KI GA PRENAŠA

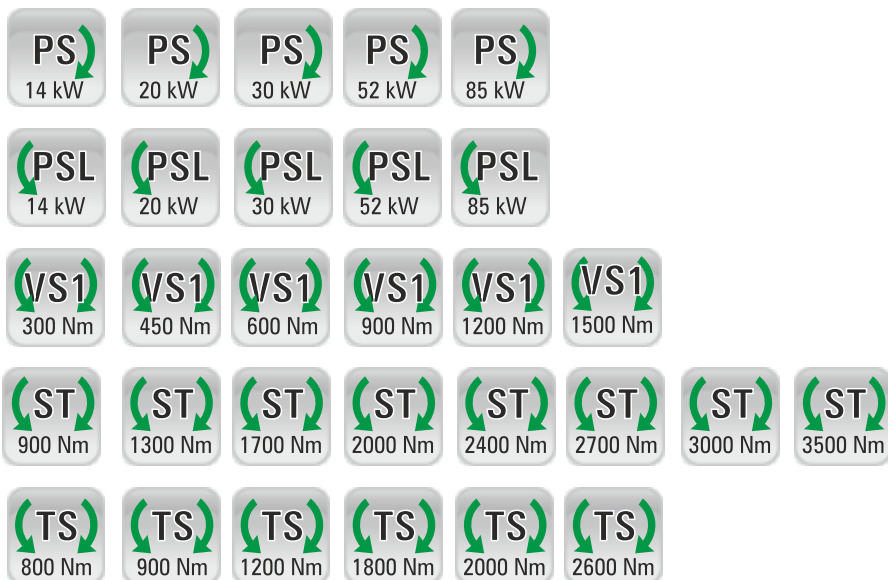

MAKSIMALNI KOT DELOVANJA KARDANSKEGA ZGLOBA



ŠTEVILO VRTLJAJEV (MIN⁻¹) POGONKEGA STROJA



TIP PROFILA NA PRIKLOPU



KAKO IZBRATI USTREZNO KARDANSKO GRED ...

1. VELIKOST

Pri izbiri ustrezne velikosti kardanske gredi moramo upoštevati potrebe delovnega stroja ter moment, ki ga razvije pogonski agregat. Ponavadi ne poznamo momenta, ki ga razvije pogonski agregat, poznamo pa moč pogonskega agregata in nazivno vrtilno frekvenco. Izračun momenta:

$$M \text{ (Nm)} = \frac{P \text{ (kW)} \times 9553}{n \text{ (min}^{-1}\text{)}}$$

Pri izbiri velikosti kardanske gredi tipa BR, BR+, PS, PSL upoštevajte, da izračunani moment ne presega maksimalnega momenta glede na velikost, zapisano v **tabeli 1**.

Velikost	540 min ⁻¹			1000 min ⁻¹		
	M (Nm)	P (kW)	(HP) KS	M (Nm)	P (kW)	(HP) KS
1	250	14	(19)	200	21	(28)
2	390	22	(30)	315	33	(45)
4	530	30	(40)	430	45	(61)
6	920	52	(70)	745	78	(106)
8	1500	85	(115)	1220	128	(174)

Tabela 1: Velikost, vrtilna frekvenca, moment, moč

2. IZBIRA ENOJNEGA ALI ŠIROKOKOTNEGA ZGLOBA

Kardanska gred omogoča prenos vrtilnega momenta med dvema gredema. Priporočljivi kot delovanja kardanske gredi z enojnima zgloboma znaša 25 stopinj. Kardanska gred z enojnima zgloboma se lahko vrti tudi pri kotu do 40 stopinj, vendar sme prenašati 40 % nazivnega momenta kardanske gredi. Kardanska gred s širokokotnima zgloboma lahko deluje do kota 80 stopinj, če kot presežemo, povzročimo lom kardanskega zgloba oziroma kardanske gredi. Pri kardanski gredi s širokokotnim in enojnim zglobom je potrebno paziti, da kot enojnega zgloba ne preseže 15 stopinj pri 540 obratih na minuto ali 7 stopinj pri 1000 obratih na minuto.



**PRIPOROČLJIVI KOTI DELOVANJA
KARDANSKE GREDI /
KARDANSKE GREDI OBLIKE
BR, BR+, PS, VS, TS**

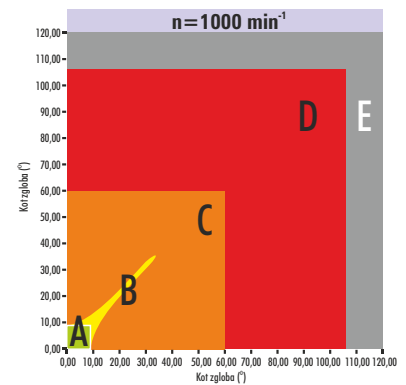
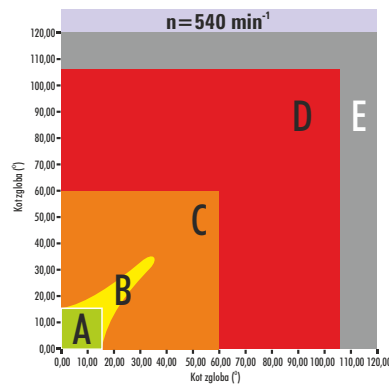

**ŠIROKOKOTNI ZGLOB
NA ENI STRANI**

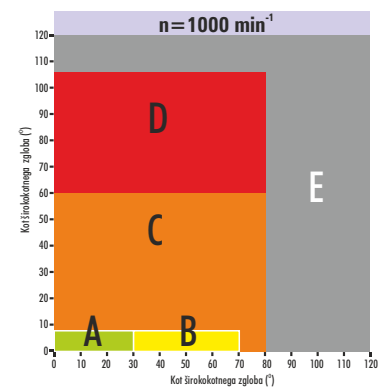
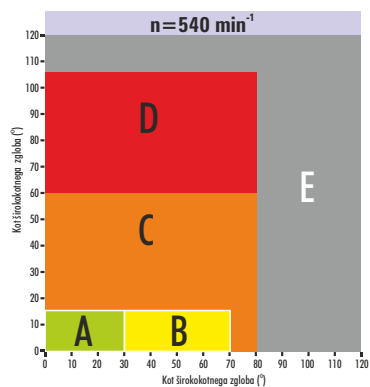



ŠIROKOKOTNI ZGLOB NA OBEH STRANEH

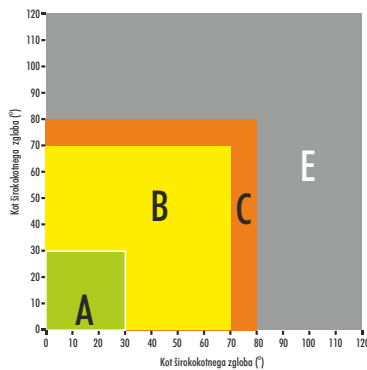

- **A** - priporočeno območje delovanja
- **B** - dovoljeno območje delovanja
- **C** - območje, v katerem se sme kardanska gred vrzeti brez prenašanja momenta
- **D** - območje dovoljenega zibanja brez vrtenja
- **E** - območje, v katerem pride do loma

3. DOLŽINA KARDANSKE GREDI

Izmerite minimalno razdaljo med priključnima gredema in tej vrednosti odštejte vrednosti podane v tabeli, glede na velikost in tip želene kardanske gredi. Tako dobite razdaljo kardanske gredi **kk**. Pri izbiri standardne kardanske gredi iz kataloga je potrebno izbrati kardansko gred, katere vrednost **kk** je prva manjša od izmerjene.

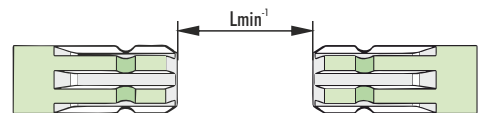

Velikost	Vrednost, ki jo je potrebno odšteti				
	BR, BR+	PS, PSL	VS	ST	TS
1	80	115	110	/	/
2	90	130	130	100	/
4	100	150	160	110	120
6	120	155	210	135	150
8	140	230	/	160	190

Primer:

Izmerjena vrednost = 796

Velikost kardanske gredi 4 Tip kardanske gredi BR = 100

Rezultat = 696

Izbrana standardna dolžina kardanske gredi **kk** = **kk660**

ARTIKEL	OZNAKA	DELOVNA DOLŽINA KARDANSKE GREDI		EAN 13 črtna koda
		priporočena L	maksimalna L	
005244	C Line 4 BR kk610 (840)	1055	1140	3831111014191
006680	C Line 4 BR kk660 (890)	1130	1240	3831111016362
006681	C Line 4 BR kk710 (940)	1205	1338	3831111016379

4. DELOVNA DOLŽINA KARDANSKIH GREDI

Pred rokovanjem s kardanskimi gredmi se seznanite s spodnjimi vrednostmi delovnih dolžin. Vrednosti so podane v milimetrih.

	kk	510	560	610	660	710	760	810	860	910	960	1010	1110	1210	1310	1410
1	Lw	693	768	843	918	993	1068	1143	1218	1293	1368	1443	1593	1743	1893	2043
	Lt	740	837	920	1003	1087	1170	1253	1337	1420	1503	1587	1753	1920	2087	2253
	Ls	740	840	940	1040	1134	1221	1309	1396	1484	1571	1659	1834	2009	2184	2359
2	Lw	680	755	830	905	980	1055	1130	1205	1280	1355	1430	1580	1730	1880	2030
	Lt	730	820	903	987	1070	1153	1237	1320	1403	1487	1570	1737	1903	2070	2237
	Ls	730	830	930	1028	1115	1203	1290	1378	1465	1553	1640	1815	1990	2165	2340
4	Lw	675	750	825	900	975	1050	1125	1200	1275	1350	1425	1575	1725	1875	2025
	Lt	710	810	897	980	1063	1147	1230	1313	1397	1480	1563	1730	1897	2063	2230
	Ls	710	810	910	1010	1108	1195	1283	1370	1458	1545	1633	1808	1983	2158	2333
6	Lw	/	733	808	883	958	1033	1108	1183	1258	1333	1408	1558	1708	1858	2008
	Lt	/	775	873	957	1040	1123	1207	1290	1373	1457	1540	1707	1873	2040	2207
	Ls	/	775	875	975	1075	1169	1256	1344	1431	1519	1606	1781	1956	2131	2306
8	Lw	/	/	/	860	935	1010	1085	1160	1235	1315	1385	1535	1685	1835	1985
	Lt	/	/	/	920	1010	1093	1177	1260	1343	1433	1510	1677	1843	2010	2177
	Ls	/	/	/	920	1020	1120	1220	1310	1398	1493	1573	1748	1923	2098	2273

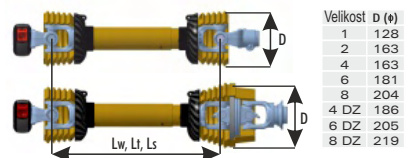

- kk** razdalja križ-križ na kardanski gredi
- Lw** maksimalna delovna dolžina **kk**
- Lt** maksimalna začasna dolžina **kk**
- Ls** maksimalna dolžina teleskopiranja **kk** brez vrtenja

- vrtilna frekvenca manjša od 1000 min⁻¹
- vrtilna frekvenca manjša od 540 min⁻¹

5. VARNOSTNI ELEMENT

Priporočila za izbiro varnostnega elementa kardanske gredi

	Vrsta sklopke		
	VS	ST	TS
1 Primernost za obdelavo humusnih tal	● ● ●	● ● ● ● ●	● ● ● ● ● ●
2 Primernost za obdelavo ilovnatih/glinenih tal	● ● ●	● ● ● ● ●	● ● ● ● ● ●
3 Primernost za obdelavo peščenih tal	● ● ●	● ● ● ● ●	● ● ● ● ● ●
4 Primernost za obdelavo kamnitih tal	● ● ●	●	● ● ●
5 Spravilo travinja	● ● ● ● ●	● ● ●	● ● ●
6 Sadjarstvo in vinogradništvo	● ● ● ● ●	●	●
7 Vzdrževanje	● ● ● ● ●	● ● ●	● ● ●
8 Čas do ponovnega zagona	● ● ● ● ●	●	● ● ● ● ● ●
9 Prijaznost do uporabnika	● ● ● ● ●	● ● ●	● ● ●

MANJ PRIMERNO 

PRIMERNO 

PRIPOROČENO 

6. POMEN OZNAK SKLOPK IN NAMEN UPORABE:



Prostotečna sklopka PS

PS "vrtenje v smeri urinega kazalca ko uporabnik gleda proti kardanski gredi pogonskega stroja (traktor)"



Prostotečna sklopka PSL

PSL "vrtenje v nasprotni smeri urinega kazalca ko uporabnik gleda proti kardanski gredi pogonskega stroja (traktor)"

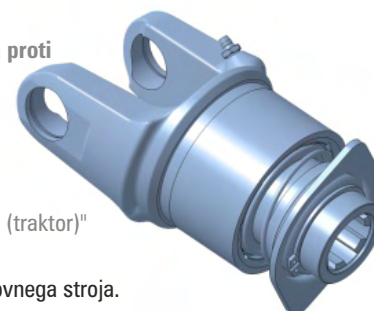

Prostotečna sklopka varuje pogonski stroj (traktor) pred obremenitvami zaradi vztrajnostnih mas delovnega stroja.

Ta sklopka ne varuje stroja pred preobremenitvami. Namenjena je predvsem za stroje, pri katerih se z veliko hitrostjo vrtijo večje mase – rotor.

To so predvsem rotacijske kose, mulčarji ipd. Prostotečna sklopka varuje pogonski stroj pred pogonsko energijo vztrajnostnih mas stroja.

Pred izbiro se prepričajte ali je v vašem stroju že vgrajena prostotečna sklopka.

Kombinacija PS + TS je možna na zahtevo.



Varnostna sklopka VS

Varnostna sklopka VS1 varuje delovni stroj pred preobremenitvami. Namenjena je za stroje, ki nimajo

vgrajenega varovanja navora. Pri zdrsu sklopke je potrebna zaustavitev stroja z namenom, da se ugotovi,

vzrok za zaustavitev stroja. Če je vzrok za vklop sklopke preobremenitev stroja, je potrebno zmanjšanje obremenitve – zmanjšanje delovne hitrosti....

Ob aktiviranju sklopke se navor na stroj prenaša samo do nastavljenega navora, presežek navora pa se ne prenaša na stroj, ampak se izloči preko sklopke. Pri daljšem aktiviranju sklopke se sklopka zaradi odvoda odvečnega navora začne segrevati in posledično prihaja tudi do utrujanja vzmeti, ki določajo navor sklopke. Če je sklopka večkrat po dlje časa aktivirana, se zmanjša tovarniška nastavitev in posledično

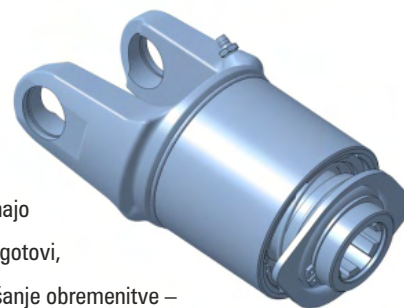

se zmanjša prenos navora na stroj. V takem primeru je potrebno izvesti servis VS1 sklopke pri pooblaščenem serviserju, kateri ima na razpolago vso ustrezno orodje za varno demontažo, ponovno sestavo in seveda končno kontrolo pravilnega delovanja. (Razstavljanje VS1 sklopke brez ustreznih pripomočkov lahko povzroči resne poškodbe, ker se sprošča pri demontaži energija prednapetih vzmeti – nevarnost letečih predmetov.)

Nazivni moment sklopke je nastavljen pri proizvajalcu in v velikostnem razredu 300Nm do 1500Nm. Uporabljajo se predvsem za samonakladalne prikolice, obračalnike pajke, zgrabljalnike, trosilnike hlevskega gnoja, obiralce koruze ...



Strižna sklopka ST

Strižna sklopka ST varuje delovni stroj pred preobremenitvami. Namenjena je za stroje v katerih ni vgrajeno varovanje in je potrebna takojšnja zaustavitev prenosa vrtilnega momenta. Sklopka omejuje navor podobno kot sklopke VS, VS1 in TS, s tem, da se ob preseženem navoru takoj ustavi prenos moči na stroj (strižni vijak se zlomi) in stroj nima več pogona preko kardanske gredi. Stroj se ustavi, zato je za nadaljnje delo potrebno zamenjati strižni vijak enakega trdnostnega razreda in velikosti.

Naša patentirana sklopka ponuja več možnosti nastavitve nazivnega navora na eni sklopki, ki jih je mogoče preprosto spremeniti. Naša sklopka je bolj simetrična, kar vpliva na zmanjšanje tresljajev zaradi ekscentričnih mas. Tudi menjava varnostnega elementa je poenostavljena zaradi oblike utora matice, ki preprečuje vrtenje matice pri vijačenju - za menjavo je potreben le en ključ.

Razpon je od 900Nm do 3500Nm in je odvisen od velikosti. Uporabljajo se predvsem za stroje namenjene obdelavi tal, kot so rotacijske freze, vrtavkaste brane itd.

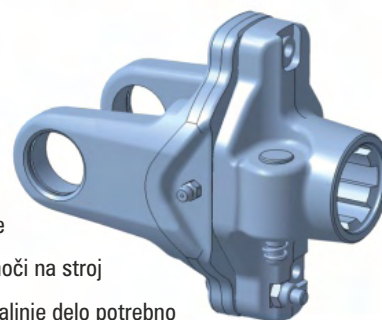

Torna sklopka TS

Torna sklopka TS varuje delovni stroj pred preobremenitvami. Pri zdrsu sklopke ni potrebna zaustavitev prenosa vrtilnega momenta. Ob aktiviranju sklopke se še vedno prenaša navor na stroj vendar samo do nastavljenega navora, presežek navora pa se izloči preko sklopke. Pri daljšem aktiviranju sklopke se sklopka zaradi odvoda odvečnega navora začne segrevati in posledično prihaja tudi do obrabe tornih oblog, ki določajo navor sklopke. Če je sklopka večkrat po dlje časa aktivirana, se zmanjša tovarniška nastavev in posledično se zmanjša prenos navora na stroj.

Smo pa olajšali vzdrževanje – na torni sklopki so štiri luknje, ki omogočajo razbremenitev torne površine pred sezono.

Vrtilni moment medtem ostane nastavljen - ni ga treba ponovno nastavljanje. Zaradi oblike vilice je nastavev lažja in bolj ergonomična.

Oblika vilice drži vijak med prilagajanjem, za to pa potrebujete samo en ključ namesto dva.

Nazivni navor sklopke je tovarniško nastavljen z razponom od 800 Nm do 2600 Nm. Sklopke se uporabljajo zlasti freze, vrtavkaste brane itd.

Kombinacija PS + TS je možna na zahtevo.

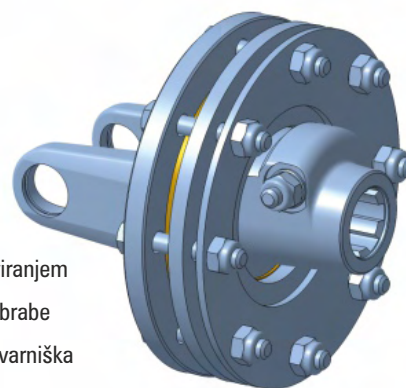

7. PROFIL PRIKLJUČNEGA MESTA

Priključne gredi na traktorjih in strojih so izdelane po predpisanih standardnih dimenzijah. Različni stroji zaradi specifičnih potreb uporabljajo različne standardne profile, zato je pri izbiri priključnega profila kardanske gredi potrebno pravilno določiti profil na obeh straneh kardanske gredi. Spodaj so predstavljeni profili priključnega mesta. Za priključne gredi, ki niso navedene spodaj, vas prosimo, da nam pošljete povpraševanje, saj lahko izdelamo tudi priključna mesta po naročilu.

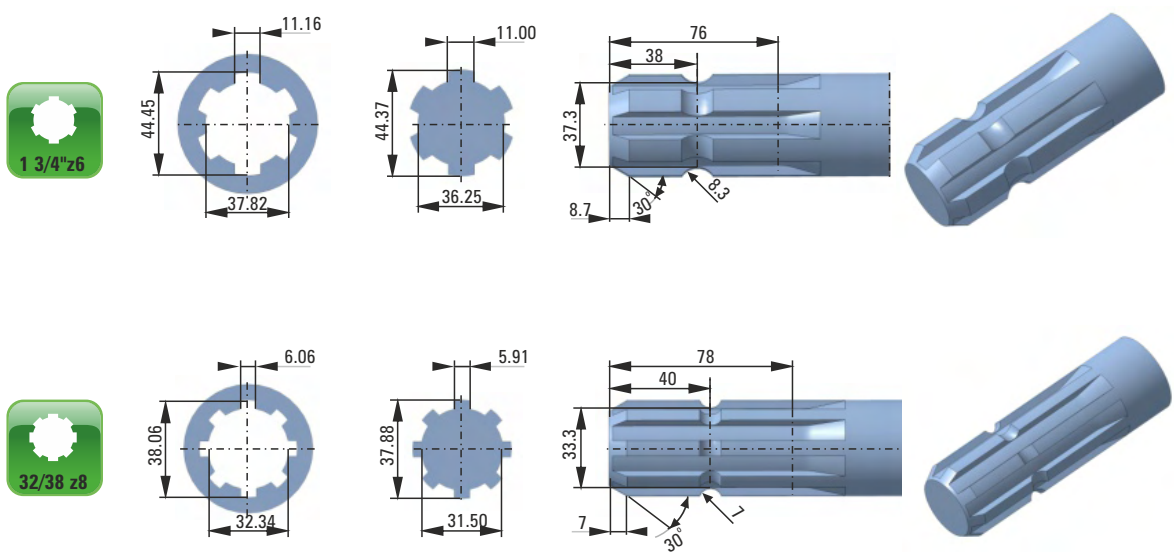
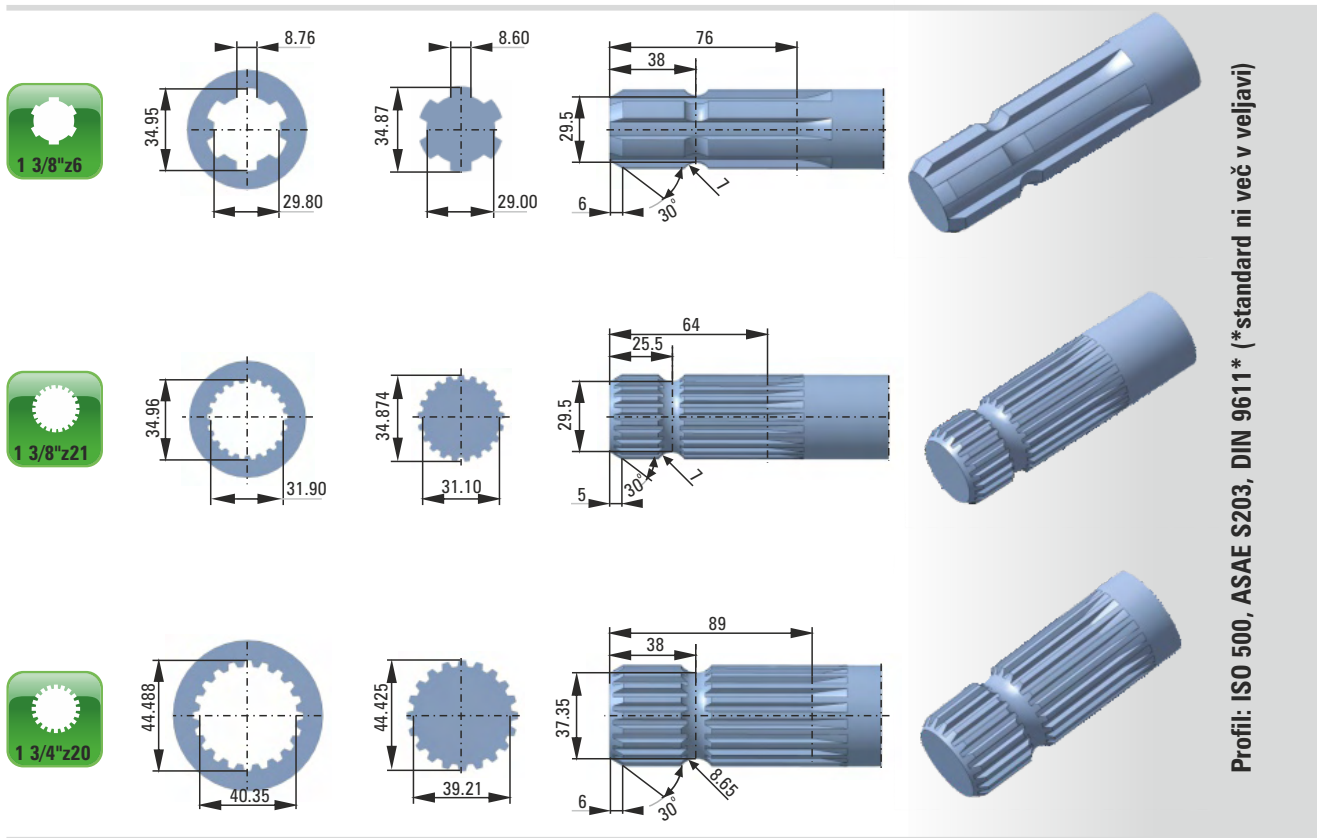

POVPREČNA ŽIVLJENJSKA DOBA

Vzdržljivost kardanske gredi je običajno povezana z življenjsko dobo ležajev kardanskega zgloba, ki je odvisna od momenta, hitrosti vrtenja in kota, pod katerim deluje.

Spodnji graf prikazuje princip, po katerem lahko definiramo:

1. Velikost kardanske gredi (glede na pričakovano življenjsko dobo, kot delovanja, hitrost vrtenja in moment)
2. Življenjsko dobo kardanske gredi (glede na velikost, moment, hitrost vrtenja in kot delovanja)

Primer 1: ←

Življenjska doba (ur)	500	500
Kot delovanja	(0 stopinj)	(20 stopinj)
Hitrost vrtenja	540 min ⁻¹	540 min ⁻¹
Moment	500 Nm	500 Nm
Ustrezna velikost kardanske gredi		

Primer 2: →

Velikost		
Moment	500 Nm	500 Nm
Hitrost vrtenja	540 min ⁻¹	540 min ⁻¹
Kot delovanja	(0 stopinj)	(20 stopinj)
Življenjska doba (ur)	3000	130

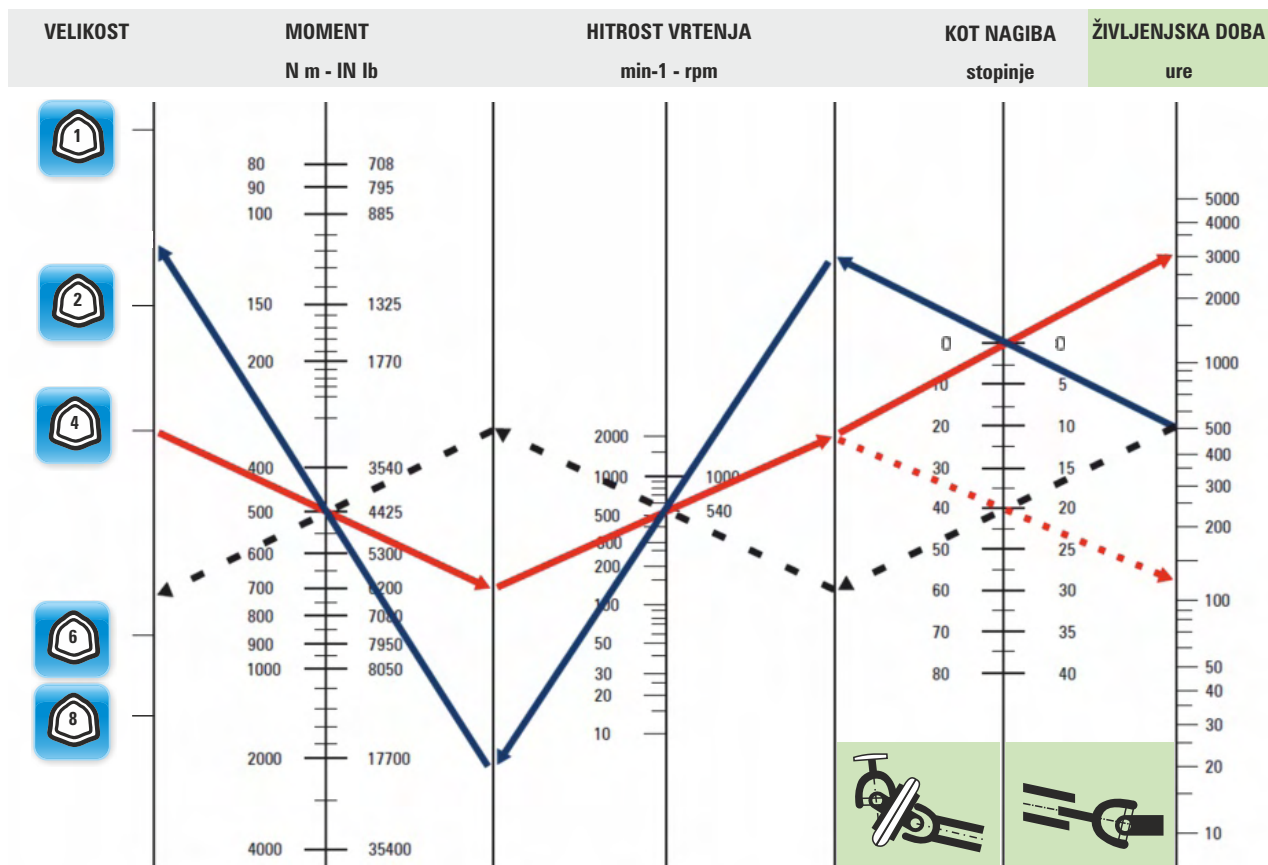



KARDANSKA GRED C Line 1 BR+

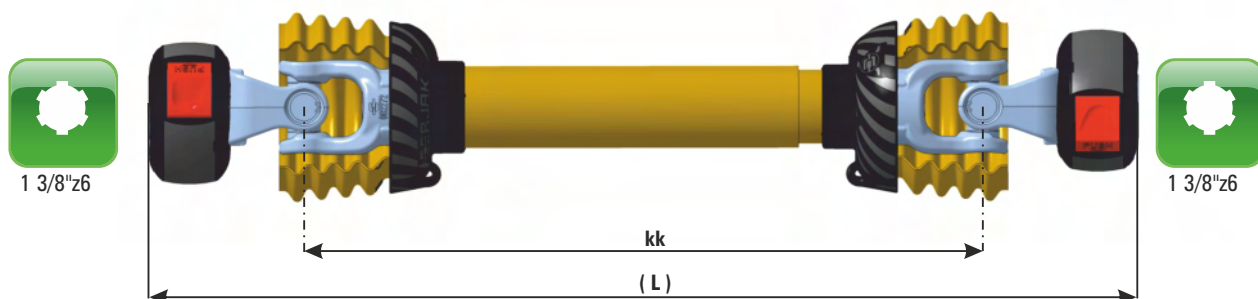

ARTIKEL	OZNAKA	DELOVNA DOLŽINA KARDANSKE GREDI		EAN 13 ČRTNA KODA
		priporočena L	maksimalna L	
007168	C Line 1 BR+ kk510 (720)	903	950	3831111020918
007170	C Line 1 BR+ kk560 (770)	978	1050	3831111020932
007171	C Line 1 BR+ kk610 (820)	1053	1150	3831111020949
007172	C Line 1 BR+ kk660 (870)	1128	1250	3831111020956
007173	C Line 1 BR+ kk710 (920)	1203	1344	3831111020963
007174	C Line 1 BR+ kk760 (970)	1278	1431	3831111020970
007175	C Line 1 BR+ kk810 (1020)	1353	1519	3831111020987
007176	C Line 1 BR+ kk860 (1070)	1428	1606	3831111020994
007177	C Line 1 BR+ kk910 (1120)	1503	1694	3831111021007
007178	C Line 1 BR+ kk960 (1170)	1578	1781	3831111021014
007179	C Line 1 BR+ kk1010 (1220)	1653	1869	3831111021021
007180	C Line 1 BR+ kk1110 (1320)	1803	2044	3831111021038
007181	C Line 1 BR+ kk1210 (1420)	1953	2219	3831111021045
007182	C Line 1 BR+ kk1310 (1520)	2103	2394	3831111021052
007183	C Line 1 BR+ kk1410 (1620)	2253	2569	3831111021069



KARDANSKA GRED C Line 1 PS

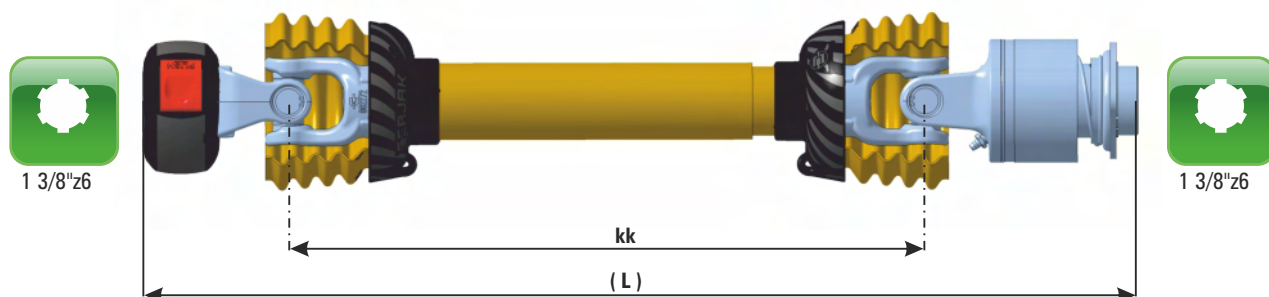







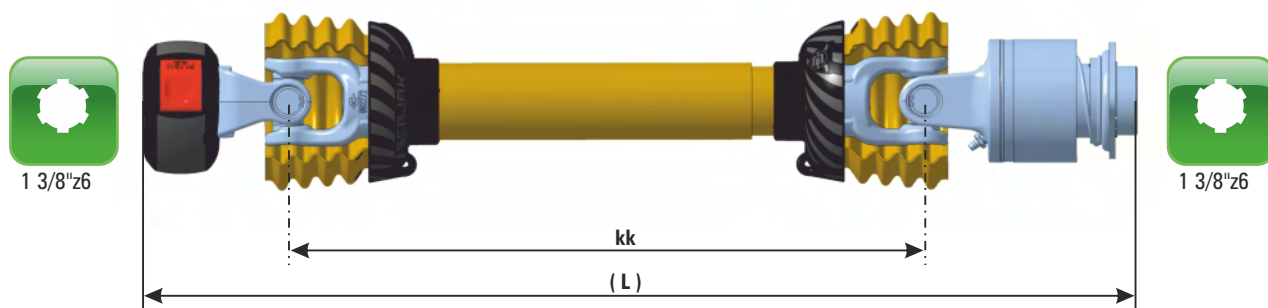







Omejena dobavljivost

ARTIKEL	OZNAKA	DELOVNA DOLŽINA KARDANSKE GREDI		EAN 13 ČRTNA KODA
		priporočena L	maksimalna L	
006858	C Line 1 PS kk510 (760)	943	990	3831111018144
006873	C Line 1 PS kk560 (810)	1018	1090	3831111018731
006875	C Line 1 PS kk610 (860)	1093	1190	3831111018755
006879	C Line 1 PS kk660 (910)	1168	1290	3831111018793
006882	C Line 1 PS kk710 (960)	1243	1384	3831111018823
006886	C Line 1 PS kk760 (1010)	1318	1471	3831111018861
006889	C Line 1 PS kk810 (1060)	1393	1559	3831111018892
006890	C Line 1 PS kk860 (1110)	1468	1646	3831111018908
006891	C Line 1 PS kk910 (1160)	1543	1734	3831111019905
006894	C Line 1 PS kk960 (1210)	1618	1821	3831111018939
006895	C Line 1 PS kk1010 (1260)	1693	1909	3831111018946
006897	C Line 1 PS kk1110 (1360)	1843	2084	3831111018953
006899	C Line 1 PS kk1210 (1460)	1993	2259	3831111018977
006902	C Line 1 PS kk1310 (1560)	2143	2434	3831111019004
006905	C Line 1 PS kk1410 (1660)	2293	2609	3831111019035

KARDANSKA GRED C Line 1 PSL



Omejena dobavljivost

ARTIKEL	OZNAKA	DELOVNA DOLŽINA KARDANSKE GREDI		EAN 13 ČRTNA KODA
		priporočena L	maksimalna L	
006916	C Line 1 PSL kk510 (760)	943	990	3831111019141 
006919	C Line 1 PSL kk560 (810)	1018	1090	3831111019172 
006921	C Line 1 PSL kk610 (860)	1093	1190	3831111019196 
006924	C Line 1 PSL kk660 (910)	1168	1290	3831111019226 
006926	C Line 1 PSL kk710 (960)	1243	1384	3831111019240 
006928	C Line 1 PSL kk760 (1010)	1318	1471	3831111019264 
006930	C Line 1 PSL kk810 (1060)	1393	1559	3831111019288 
006931	C Line 1 PSL kk860 (1110)	1468	1646	3831111019295 
006934	C Line 1 PSL kk910 (1160)	1543	1734	3831111019912 
006935	C Line 1 PSL kk960 (1210)	1618	1821	3831111019325 
006938	C Line 1 PSL kk1010 (1260)	1693	1909	3831111019356 
006941	C Line 1 PSL kk1110 (1360)	1843	2084	3831111019387 
006943	C Line 1 PSL kk1210 (1460)	1993	2259	3831111019400 
006945	C Line 1 PSL kk1310 (1560)	2143	2434	3831111019424 
006946	C Line 1 PSL kk1410 (1660)	2293	2609	3831111019431 

KARDANSKA GRED

C Line 1 VS1 300Nm

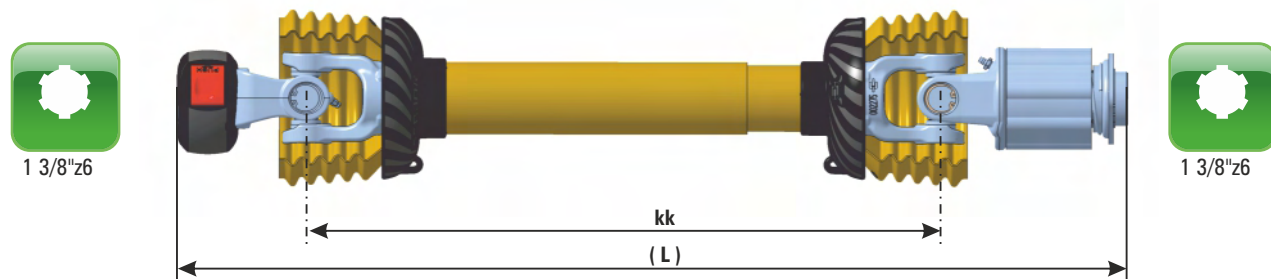

Omejena dobavljivost

ARTIKEL	OZNAKA	DELOVNA DOLŽINA KARDANSKE GREDI		EAN 13 ČRTNA KODA
		priporočena L	maksimalna L	
006950	C Line 1 VS 300Nm kk510 (730)	913	960	3831111019479
006954	C Line 1 VS 300Nm kk560 (780)	988	1060	3831111019516
006957	C Line 1 VS 300Nm kk610 (830)	1063	1160	3831111019547
006959	C Line 1 VS 300Nm kk660 (880)	1138	1260	3831111019561
006978	C Line 1 VS 300Nm kk710 (930)	1213	1354	3831111019745
006980	C Line 1 VS 300Nm kk760 (980)	1288	1441	3831111019769
006982	C Line 1 VS 300Nm kk810 (1030)	1363	1529	3831111019783
006984	C Line 1 VS 300Nm kk860 (1080)	1438	1616	3831111019806
006986	C Line 1 VS 300Nm kk910 (1130)	1513	1704	3831111019936
006988	C Line 1 VS 300Nm kk960 (1180)	1588	1791	3831111019837
006989	C Line 1 VS 300Nm kk1010 (1230)	1663	1879	3831111019844
006990	C Line 1 VS 300Nm kk1110 (1330)	1813	2054	3831111019851
006991	C Line 1 VS 300Nm kk1210 (1430)	1963	2229	3831111019868
006992	C Line 1 VS 300Nm kk1310 (1530)	2113	2404	3831111019875
006993	C Line 1 VS 300Nm kk1410 (1630)	2263	2579	3831111019882

KARDANSKA GRED C Line 1 VS1 450Nm

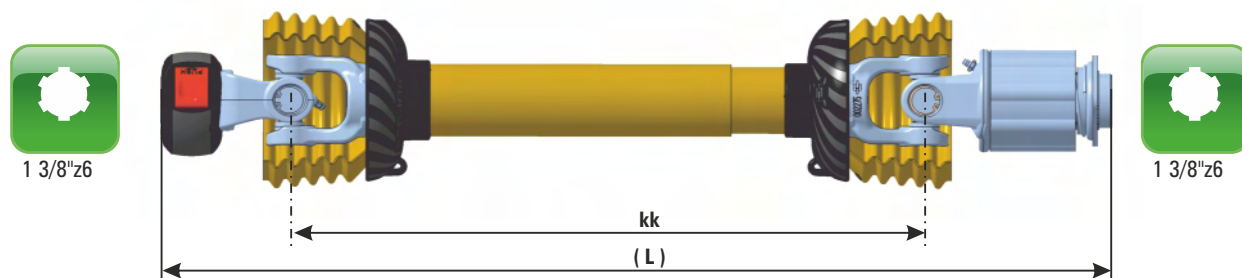

Omejena dobavljivost

ARTIKEL	OZNAKA	DELOVNA DOLŽINA KARDANSKE GREDI		EAN 13 ČRTNA KODA
		priporočena L	maksimalna L	
006952	C Line 1 VS 450Nm kk510 (750)	933	980	3831111019493
006962	C Line 1 VS 450Nm kk560 (800)	1008	1080	3831111019592
006964	C Line 1 VS 450Nm kk610 (850)	1083	1180	3831111019615
006967	C Line 1 VS 450Nm kk660 (900)	1158	1280	3831111019646
006970	C Line 1 VS 450Nm kk710 (950)	1233	1374	3831111019677
006972	C Line 1 VS 450Nm kk760 (1000)	1308	1461	3831111019691
006974	C Line 1 VS 450Nm kk810 (1050)	1383	1549	3831111019714
006975	C Line 1 VS 450Nm kk860 (1100)	1458	1636	3831111019721
006976	C Line 1 VS 450Nm kk910 (1150)	1533	1724	3831111019929
006977	C Line 1 VS 450Nm kk960 (1200)	1608	1811	3831111019738
006979	C Line 1 VS 450Nm kk1010 (1250)	1683	1899	3831111019752
006981	C Line 1 VS 450Nm kk1110 (1350)	1833	2074	3831111019776
006983	C Line 1 VS 450Nm kk1210 (1450)	1983	2249	3831111019790
006985	C Line 1 VS 450Nm kk1310 (1550)	2133	2424	3831111019813
006987	C Line 1 VS 450Nm kk1410 (1650)	2283	2599	3831111019820

KARDANSKA GRED

C Line 2 BR+

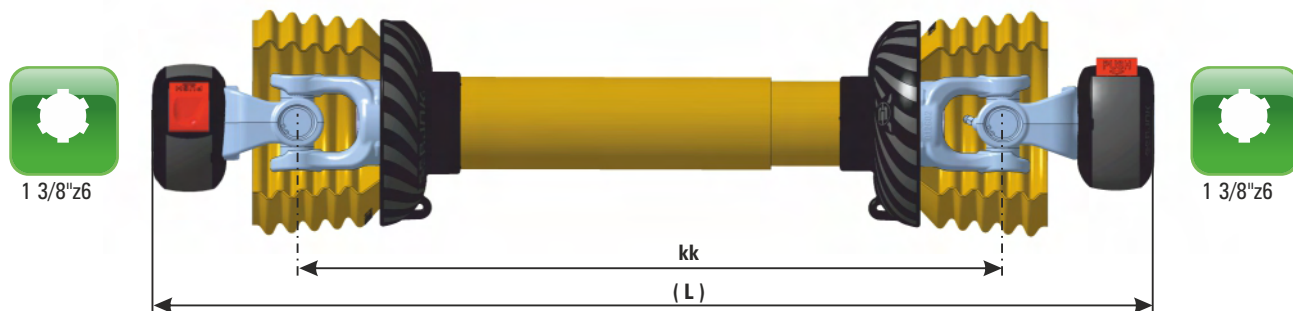

ARTIKEL	OZNAKA	DELOVNA DOLŽINA KARDANSKE GREDI		EAN 13 ČRTNA KODA
		priporočena L	maksimalna L	
018901	C Line 2 BR+ kk510 (730)	900	950	3831111096135
018902	C Line 2 BR+ kk560 (780)	970	1050	3831111096142
018904	C Line 2 BR+ kk610 (830)	1050	1150	3831111096166
018903	C Line 2 BR+ kk660 (880)	1120	1250	3831111096159
018740	C Line 2 BR+ kk710 (930)	1200	1330	3831111095527
018905	C Line 2 BR+ kk760 (980)	1270	1420	3831111096173
018906	C Line 2 BR+ kk810 (1030)	1350	1510	3831111096180
018907	C Line 2 BR+ kk860 (1080)	1420	1600	3831111096197
018908	C Line 2 BR+ kk910 (1130)	1500	1680	3831111096203
018909	C Line 2 BR+ kk960 (1180)	1570	1770	3831111096210
018910	C Line 2 BR+ kk1010 (1230)	1650	1860	3831111096227
018911	C Line 2 BR+ kk1110 (1330)	1800	2030	3831111096234
018912	C Line 2 BR+ kk1210 (1430)	1950	2210	3831111096241
018913	C Line 2 BR+ kk1310 (1530)	2100	2380	3831111096258
018914	C Line 2 BR+ kk1410 (1630)	2250	2560	3831111096265

KARDANSKA GRED C Line 2 PS

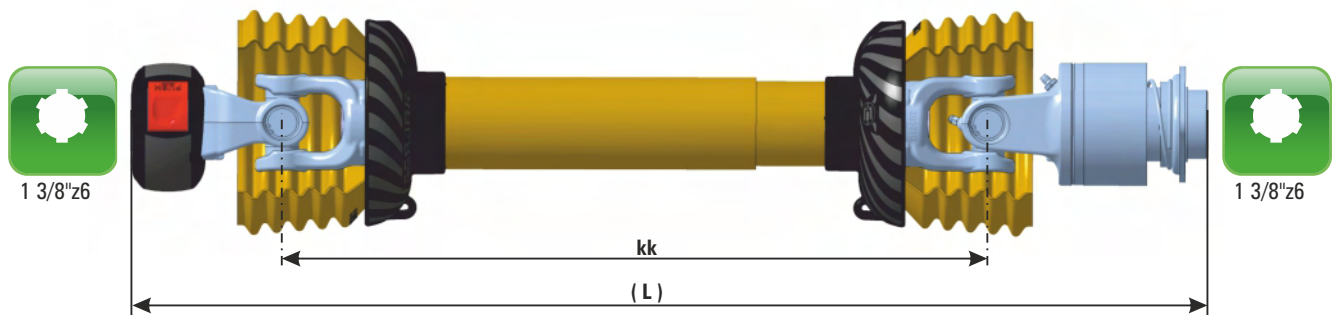

Omejena dobavljivost

ARTIKEL	OZNAKA	DELOVNA DOLŽINA KARDANSKE GREDE		EAN 13 ČRTNA KODA
		priporočena L	maksimalna L	
018915	C Line 2 PS kk510 (760)	930	930	3831111096272
018916	C Line 2 PS kk560 (810)	1000	1000	3831111096289
018917	C Line 2 PS kk610 (860)	1080	1080	3831111096296
018918	C Line 2 PS kk660 (910)	1150	1150	3831111096302
018919	C Line 2 PS kk710 (960)	1230	1230	3831111096319
018920	C Line 2 PS kk760 (1010)	1300	1300	3831111096326
018921	C Line 2 PS kk810 (1060)	1380	1380	3831111096333
018922	C Line 2 PS kk860 (1110)	1450	1450	3831111096340
018760	C Line 2 PS kk910 (1160)	1530	1530	3831111095596
018923	C Line 2 PS kk960 (1210)	1600	1600	3831111096357
018924	C Line 2 PS kk1010 (1260)	1680	1680	3831111096364
018925	C Line 2 PS kk1110 (1360)	1830	1830	3831111096371
018926	C Line 2 PS kk1210 (1460)	1980	1980	3831111096388
018927	C Line 2 PS kk1310 (1560)	2130	2130	3831111096395
018928	C Line 2 PS kk1410 (1660)	2280	2280	3831111096401

KARDANSKA GRED

C Line 2 PSL

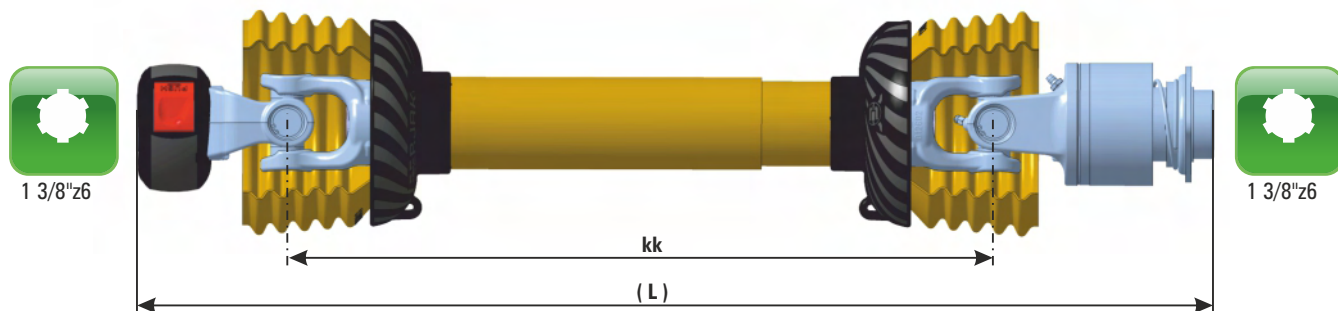

Omejena dobavljivost

ARTIKEL	OZNAKA	DELOVNA DOLŽINA KARDANSKE GREDI		EAN 13 ČRTNA KODA
		priporočena L	maksimalna L	
018929	C Line 2 PSL kk510 (760)	930	930	3831111096418
018930	C Line 2 PSL kk560 (810)	1000	1000	3831111096425
018931	C Line 2 PSL kk610 (860)	1080	1080	3831111096432
018932	C Line 2 PSL kk660 (910)	1150	1150	3831111096449
018933	C Line 2 PSL kk710 (960)	1230	1230	3831111096456
018934	C Line 2 PSL kk760 (1010)	1300	1300	3831111096463
018935	C Line 2 PSL kk810 (1060)	1380	1380	3831111096470
018936	C Line 2 PSL kk860 (1110)	1450	1450	3831111096487
018767	C Line 2 PSL kk910 (1160)	1530	1530	3831111095640
018937	C Line 2 PSL kk960 (1210)	1600	1600	3831111096494
018938	C Line 2 PSL kk1010 (1260)	1680	1680	3831111096500
018939	C Line 2 PSL kk1110 (1360)	1830	1830	3831111096517
018940	C Line 2 PSL kk1210 (1460)	1980	1980	3831111096524
018941	C Line 2 PSL kk1310 (1560)	2130	2130	3831111096531
018942	C Line 2 PSL kk1410 (1660)	2280	2280	3831111096548

KARDANSKA GRED C Line 2 VS1 450Nm



1 3/8"z6

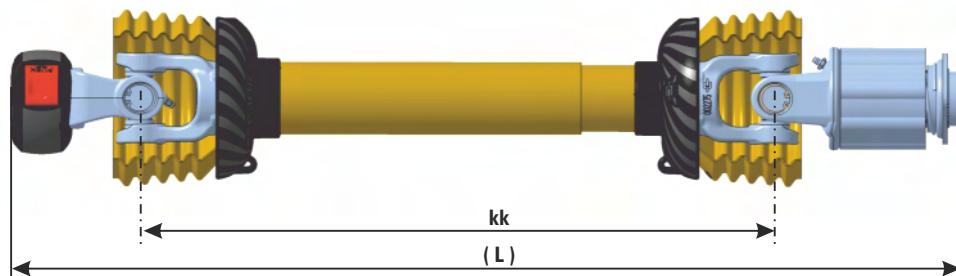

1 3/8"z6

Omejena dobavljivost

ARTIKEL	OZNAKA	DELOVNA DOLŽINA KARDANSKE GREDI		EAN 13 ČRTNA KODA
		priporočena L	maksimalna L	
018943	C Line 2 VS 450Nm kk510 (760)	930	980	3831111096555
018944	C Line 2 VS 450Nm kk560 (810)	1000	1080	3831111096562
018945	C Line 2 VS 450Nm kk610 (860)	1080	1180	3831111096579
018946	C Line 2 VS 450Nm kk660 (910)	1150	1280	3831111096586
018947	C Line 2 VS 450Nm kk710 (960)	1230	1360	3831111096593
018948	C Line 2 VS 450Nm kk760 (1010)	1300	1450	3831111096609
018482	C Line 2 VS 450Nm kk810 (1060)	1380	1540	3831111094926
018951	C Line 2 VS 450Nm kk860 (1110)	1450	1630	3831111096616
018773	C Line 2 VS 450Nm kk910 (1160)	1530	1710	3831111095695
018952	C Line 2 VS 450Nm kk960 (1210)	1600	1800	3831111096623
018954	C Line 2 VS 450Nm kk1010 (1260)	1680	1890	3831111096630
018955	C Line 2 VS 450Nm kk1110 (1360)	1830	2060	3831111096647
018956	C Line 2 VS 450Nm kk1210 (1460)	1980	2240	3831111096654
018957	C Line 2 VS 450Nm kk1310 (1560)	2130	2410	3831111096661
018958	C Line 2 VS 450Nm kk1410 (1660)	2280	2590	3831111096678



KARDANSKA GRED

C Line 2 VS1 600Nm

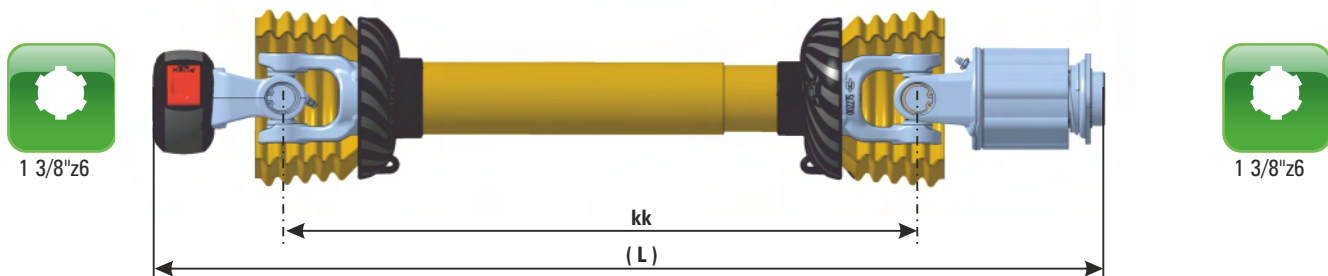

Omejena dobavljivost

ARTIKEL	OZNAKA	DELOVNA DOLŽINA KARDANSKE GREDI		EAN 13 ČRTNA KODA
		priporočena L	maksimalna L	
018959	C Line 2 VS 600Nm kk510 (760)	965	1000	3831111096685
018960	C Line 2 VS 600Nm kk560 (810)	1040	1100	3831111096692
018961	C Line 2 VS 600Nm kk610 (860)	1115	1200	3831111096708
018962	C Line 2 VS 600Nm kk660 (910)	1190	1300	3831111096715
018963	C Line 2 VS 600Nm kk710 (960)	1265	1398	3831111096722
018965	C Line 2 VS 600Nm kk760 (1010)	1340	1485	3831111096739
018966	C Line 2 VS 600Nm kk810 (1060)	1415	1573	3831111096746
018967	C Line 2 VS 600Nm kk860 (1110)	1490	1660	3831111096753
018774	C Line 2 VS 600Nm kk910 (1160)	1565	1748	3831111095701
018968	C Line 2 VS 600Nm kk960 (1210)	1640	1835	3831111096760
018969	C Line 2 VS 600Nm kk1010 (1260)	1715	1923	3831111096777
018970	C Line 2 VS 600Nm kk1110 (1360)	1840	1990	3831111096784
018971	C Line 2 VS 600Nm kk1210 (1460)	1990	2235	3831111096791
018972	C Line 2 VS 600Nm kk1310 (1560)	2140	2410	3831111096807
018973	C Line 2 VS 600Nm kk1410 (1660)	2290	2585	3831111096814

KARDANSKA GRED C Line 4 BR+

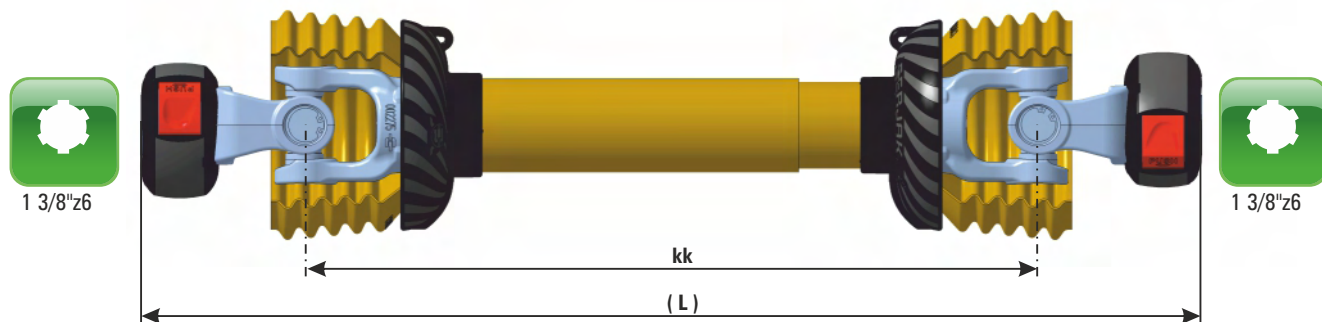

ARTIKEL	OZNAKA	DELOVNA DOLŽINA KARDANSKE GREDI		EAN 13 ČRTNA KODA
		priporočena L	maksimalna L	
007184	C Line 4 BR+ kk510 (740)	905	940	3831111021076
007186	C Line 4 BR+ kk560 (790)	980	1040	3831111021090
007187	C Line 4 BR+ kk610 (840)	1055	1140	3831111021106
007188	C Line 4 BR+ kk660 (890)	1130	1240	3831111021113
007189	C Line 4 BR+ kk710 (940)	1205	1338	3831111021120
007190	C Line 4 BR+ kk760 (990)	1280	1425	3831111021137
007191	C Line 4 BR+ kk810 (1040)	1355	1513	3831111021144
007192	C Line 4 BR+ kk860 (1090)	1430	1600	3831111021151
007193	C Line 4 BR+ kk910 (1140)	1505	1688	3831111021168
007195	C Line 4 BR+ kk960 (1190)	1580	1775	3831111021175
007197	C Line 4 BR+ kk1010 (1240)	1655	1863	3831111021182
007198	C Line 4 BR+ kk1110 (1340)	1780	1930	3831111021199
007200	C Line 4 BR+ kk1210 (1440)	1930	2175	3831111021205
007201	C Line 4 BR+ kk1310 (1540)	2080	2350	3831111021212
007204	C Line 4 BR+ kk1410 (1640)	2230	2525	3831111021229



KARDANSKA GRED C Line 4 PS

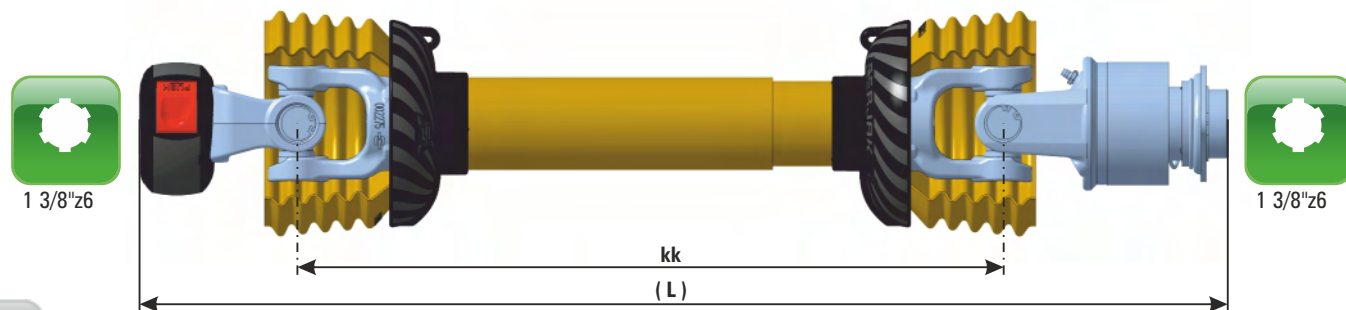

ARTIKEL	OZNAKA	DELOVNA DOLŽINA KARDANSKE GREDI		EAN 13 ČRTNA KODA	
		priporočena L	maksimalna L		
006696	C Line 4 PS kk510 (790)	955	990	3831111016492	
006697	C Line 4 PS kk560 (840)	1030	1090	3831111016508	
005245	C Line 4 PS kk610 (890)	1105	1190	3831111014207	
006698	C Line 4 PS kk660 (940)	1180	1290	3831111016553	
006699	C Line 4 PS kk710 (990)	1255	1388	3831111016560	
006700	C Line 4 PS kk760 (1040)	1330	1475	3831111016577	
006702	C Line 4 PS kk810 (1090)	1405	1563	3831111016584	
006703	C Line 4 PS kk860 (1140)	1480	1650	3831111016591	
006704	C Line 4 PS kk910 (1190)	1555	1738	3831111016607	
006705	C Line 4 PS kk960 (1240)	1630	1825	3831111016614	
006706	C Line 4 PS kk1010 (1290)	1705	1913	3831111016621	
006707	C Line 4 PS kk1110 (1390)	1830	1980	3831111016638	
006708	C Line 4 PS kk1210 (1490)	1980	2225	3831111016645	
006709	C Line 4 PS kk1310 (1590)	2130	2400	3831111016652	
006710	C Line 4 PS kk1410 (1690)	2280	2575	3831111016669	

*Opcija PS + TS

KARDANSKA GRED C Line 4 PSL

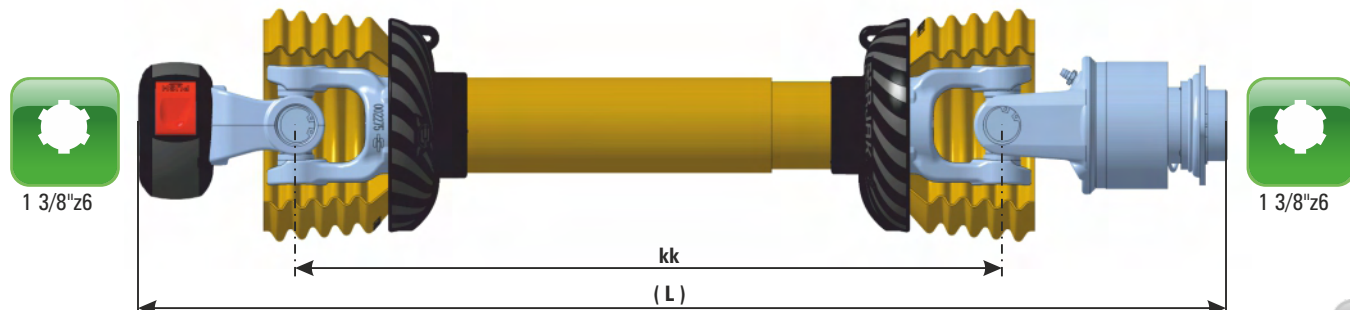

ARTIKEL	OZNAKA	DELOVNA DOLŽINA KARDANSKE GREDI		EAN 13 ČRTNA KODA	
		priporočena L	maksimalna L		
006712	C Line 4 PSL kk510 (790)	955	990	3831111016683	
006713	C Line 4 PSL kk560 (840)	1030	1090	3831111016690	
006714	C Line 4 PSL kk610 (890)	1105	1190	3831111016706	
006715	C Line 4 PSL kk660 (940)	1180	1290	3831111016713	
006716	C Line 4 PSL kk710 (990)	1255	1388	3831111016720	
006717	C Line 4 PSL kk760 (1040)	1330	1475	3831111016737	
006718	C Line 4 PSL kk810 (1090)	1405	1563	3831111016744	
006719	C Line 4 PSL kk860 (1140)	1480	1650	3831111016751	
006720	C Line 4 PSL kk910 (1190)	1555	1738	3831111016768	
006721	C Line 4 PSL kk960 (1240)	1630	1825	3831111016775	
006722	C Line 4 PSL kk1010 (1290)	1705	1913	3831111016782	
006723	C Line 4 PSL kk1110 (1390)	1830	1980	3831111016799	
006724	C Line 4 PSL kk1210 (1490)	1980	2225	3831111016805	
006725	C Line 4 PSL kk1310 (1590)	2130	2400	3831111016812	
006726	C Line 4 PSL kk1410 (1690)	2280	2575	3831111016829	

KARDANSKA GRED

C Line 4 VS1 600Nm

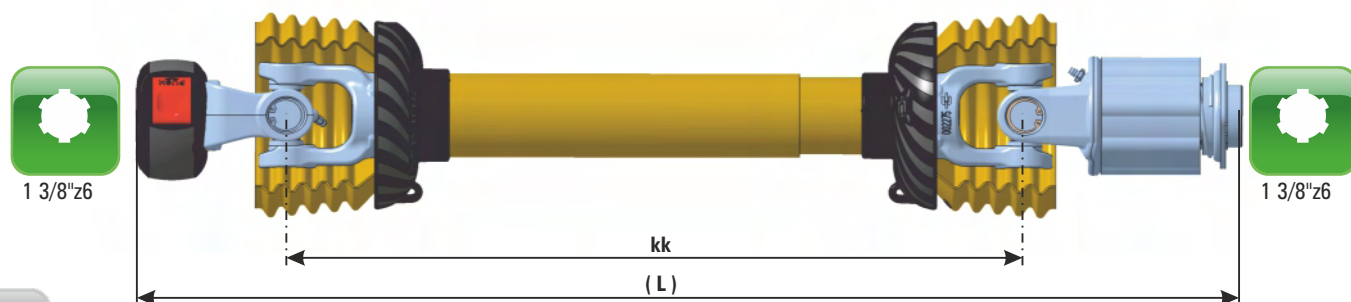

ARTIKEL	OZNAKA	DELOVNA DOLŽINA KARDANSKE GREDI		EAN 13 ČRTNA KODA	EAN 13 ČRTNA KODA
		priporočena L	maksimalna L		
006728	C Line 4 VS 600Nm kk510 (780)	945	980	3831111016843	
006729	C Line 4 VS 600Nm kk560 (830)	1020	1080	3831111016850	
006730	C Line 4 VS 600Nm kk610 (880)	1095	1180	3831111016867	
006731	C Line 4 VS 600Nm kk660 (930)	1170	1280	3831111016874	
006732	C Line 4 VS 600Nm kk710 (980)	1245	1378	3831111016881	
006733	C Line 4 VS 600Nm kk760 (1030)	1320	1465	3831111016898	
006734	C Line 4 VS 600Nm kk810 (1080)	1395	1553	3831111016904	
006735	C Line 4 VS 600Nm kk860 (1130)	1470	1640	3831111016911	
006736	C Line 4 VS 600Nm kk910 (1180)	1545	1728	3831111016928	
006737	C Line 4 VS 600Nm kk960 (1230)	1620	1815	3831111016935	
006738	C Line 4 VS 600Nm kk1010 (1280)	1695	1903	3831111016942	
006739	C Line 4 VS 600Nm kk1110 (1380)	1820	1970	3831111016959	
006740	C Line 4 VS 600Nm kk1210 (1480)	1970	2215	3831111016966	
006741	C Line 4 VS 600Nm kk1310 (1580)	2120	2390	3831111016973	
006742	C Line 4 VS 600Nm kk1410 (1680)	2270	2565	3831111016980	

KARDANSKA GRED C Line 4 VS1 900Nm

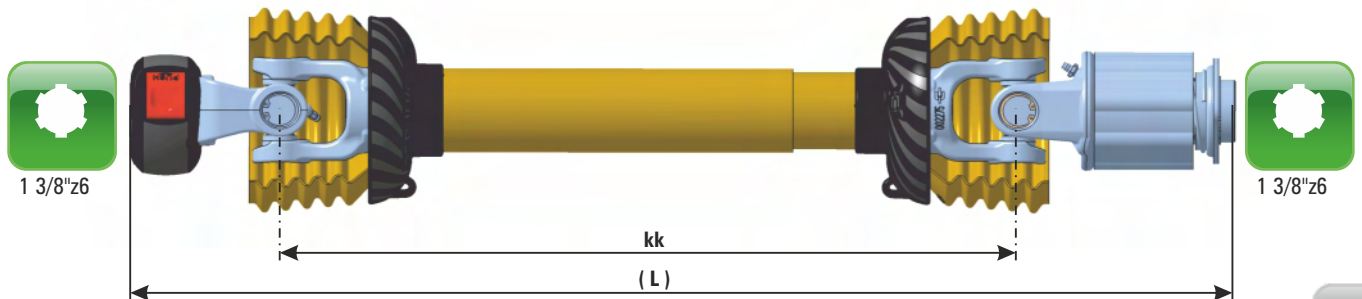

ARTIKEL	OZNAKA	DELOVNA DOLŽINA KARDANSKE GREDE		EAN 13 ČRTNA KODA
		priporočena L	maksimalna L	
006744	C Line 4 VS 900Nm kk510 (800)	965	1000	3831111017024
006745	C Line 4 VS 900Nm kk560 (850)	1040	1100	3831111017031
006746	C Line 4 VS 900Nm kk610 (900)	1115	1200	3831111017048
006747	C Line 4 VS 900Nm kk660 (950)	1190	1300	3831111017055
006748	C Line 4 VS 900Nm kk710 (1000)	1265	1398	3831111017062
006749	C Line 4 VS 900Nm kk760 (1050)	1340	1485	3831111017079
006750	C Line 4 VS 900Nm kk810 (1100)	1415	1573	3831111017086
006751	C Line 4 VS 900Nm kk860 (1150)	1490	1660	3831111017093
006752	C Line 4 VS 900Nm kk910 (1200)	1565	1748	3831111017109
006753	C Line 4 VS 900Nm kk960 (1250)	1640	1835	3831111017116
006754	C Line 4 VS 900Nm kk1010 (1300)	1715	1923	3831111017123
006755	C Line 4 VS 900Nm kk1110 (1400)	1840	1990	3831111017130
006756	C Line 4 VS 900Nm kk1210 (1500)	1990	2235	3831111017147
006757	C Line 4 VS 900Nm kk1310 (1600)	2140	2410	3831111017154
006758	C Line 4 VS 900Nm kk1410 (1700)	2290	2585	3831111017161

KARDANSKA GRED

C Line 4 ST 900Nm

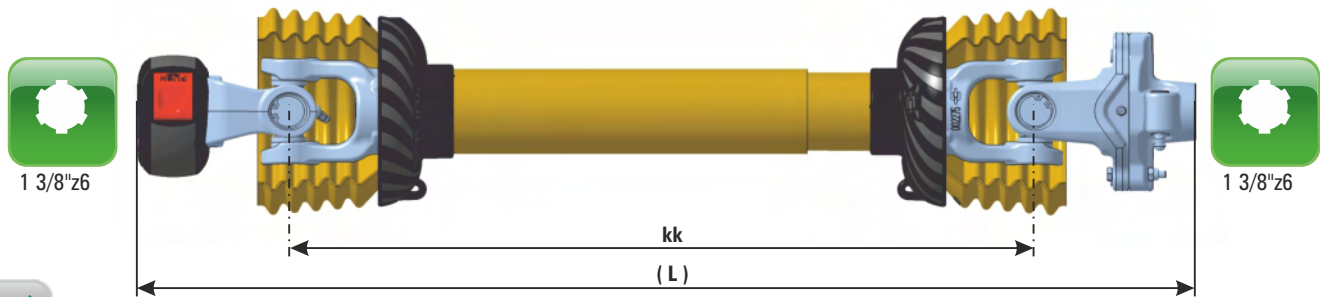

ARTIKEL	OZNAKA	DELOVNA DOLŽINA KARDANSKE GREDI		EAN 13 ČRTNA KODA	
		priporočena L	maksimalna L		
006760	C Line 4 ST 900Nm kk510 (740)	905	940	3831111017185	
006761	C Line 4 ST 900Nm kk560 (790)	980	1040	3831111017192	
006762	C Line 4 ST 900Nm kk610 (840)	1055	1140	3831111017208	
006763	C Line 4 ST 900Nm kk660 (890)	1130	1240	3831111017215	
006764	C Line 4 ST 900Nm kk710 (940)	1205	1338	3831111017222	
006765	C Line 4 ST 900Nm kk760 (990)	1280	1425	3831111017239	
006766	C Line 4 ST 900Nm kk810 (1040)	1355	1513	3831111017246	
006767	C Line 4 ST 900Nm kk860 (1090)	1430	1600	3831111017253	
006768	C Line 4 ST 900Nm kk910 (1140)	1505	1688	3831111017260	
006769	C Line 4 ST 900Nm kk960 (1190)	1580	1775	3831111017277	
006770	C Line 4 ST 900Nm kk1010 (1240)	1655	1863	3831111017284	
006771	C Line 4 ST 900Nm kk1110 (1340)	1780	1930	3831111017291	
006772	C Line 4 ST 900Nm kk1210 (1440)	1930	2175	3831111017307	
006773	C Line 4 ST 900Nm kk1310 (1540)	2080	2350	3831111017314	
006774	C Line 4 ST 900Nm kk1410 (1640)	2230	2525	3831111017321	

KARDANSKA GRED C Line 4 ST 1300Nm

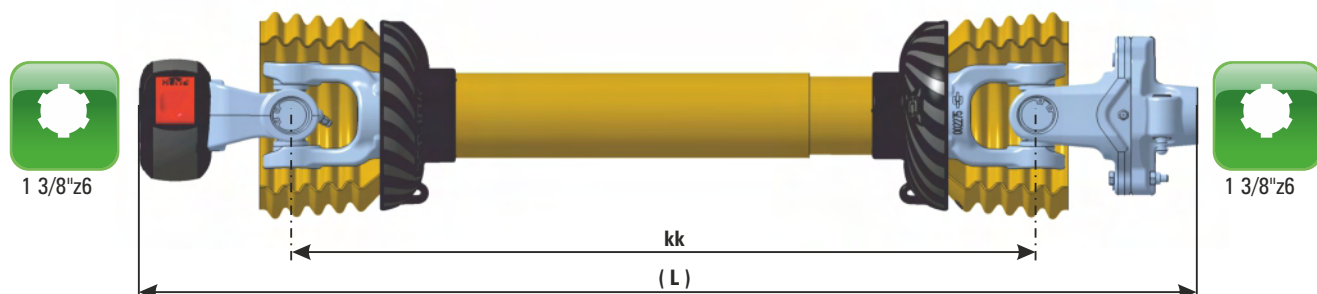

ARTIKEL	OZNAKA	DELOVNA DOLŽINA KARDANSKE GREDE		EAN 13 ČRTNA KODA
		priporočena L	maksimalna L	
028279	C Line 4 ST 1300Nm kk510 (740)	905	940	3838433013772
028280	C Line 4 ST 1300Nm kk560 (790)	980	1040	3838433013789
028281	C Line 4 ST 1300Nm kk610 (840)	1055	1140	3838433013796
028282	C Line 4 ST 1300Nm kk660 (890)	1130	1240	3838433013802
024290	C Line 4 ST 1300Nm kk710 (940)	1205	1338	3838433008716
028283	C Line 4 ST 1300Nm kk760 (990)	1280	1425	3838433013819
028284	C Line 4 ST 1300Nm kk810 (1040)	1355	1513	3838433013826
028285	C Line 4 ST 1300Nm kk860 (1090)	1430	1600	3838433013833
028286	C Line 4 ST 1300Nm kk910 (1140)	1505	1688	3838433013840
028287	C Line 4 ST 1300Nm kk960 (1190)	1580	1775	3838433013857
028288	C Line 4 ST 1300Nm kk1010 (1240)	1655	1863	3838433013864
028289	C Line 4 ST 1300Nm kk1110 (1340)	1780	1930	3838433013871
028290	C Line 4 ST 1300Nm kk1210 (1440)	1930	2175	3838433013888
028291	C Line 4 ST 1300Nm kk1310 (1540)	2080	2350	3838433013895
028292	C Line 4 ST 1300Nm kk1410 (1640)	2230	2525	3838433013901

KARDANSKA GRED

C Line 4 ST 1700Nm

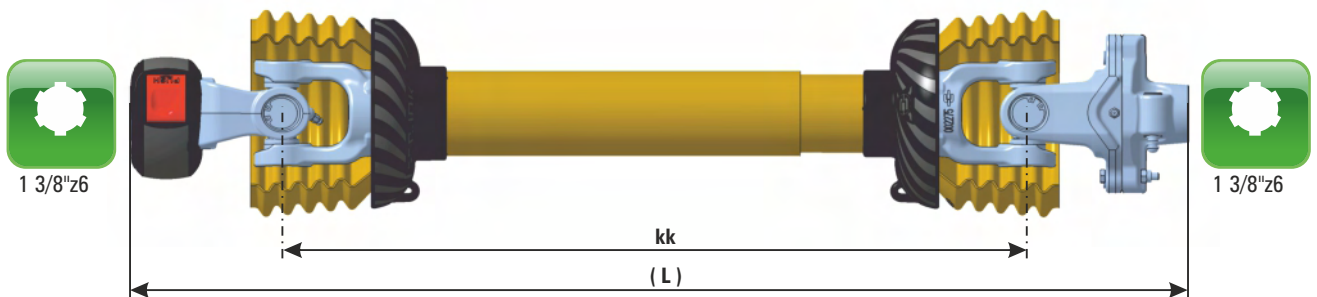

ARTIKEL	OZNAKA	DELOVNA DOLŽINA KARDANSKE GREDI		EAN 13 ČRTNA KODA	EAN 13 ČRTNA KODA
		priporočena L	maksimalna L		
006778	C Line 4 ST 1700Nm kk510 (740)	905	940	3831111017352	
006779	C Line 4 ST 1700Nm kk560 (790)	980	1040	3831111017369	
006780	C Line 4 ST 1700Nm kk610 (840)	1055	1140	3831111017376	
006781	C Line 4 ST 1700Nm kk660 (890)	1130	1240	3831111017383	
006783	C Line 4 ST 1700Nm kk710 (940)	1205	1338	3831111017413	
006784	C Line 4 ST 1700Nm kk760 (990)	1280	1425	3831111017420	
006785	C Line 4 ST 1700Nm kk810 (1040)	1355	1513	3831111017437	
006787	C Line 4 ST 1700Nm kk860 (1090)	1430	1600	3831111017444	
006788	C Line 4 ST 1700Nm kk910 (1140)	1505	1688	3831111017451	
006789	C Line 4 ST 1700Nm kk960 (1190)	1580	1775	3831111017468	
006790	C Line 4 ST 1700Nm kk1010 (1240)	1655	1863	3831111017475	
006791	C Line 4 ST 1700Nm kk1110 (1340)	1780	1930	3831111017482	
006792	C Line 4 ST 1700Nm kk1210 (1440)	1930	2175	3831111017499	
006794	C Line 4 ST 1700Nm kk1310 (1540)	2080	2350	3831111017505	
006796	C Line 4 ST 1700Nm kk1410 (1640)	2230	2525	3831111017512	

KARDANSKA GRED C Line 4 TS 800Nm

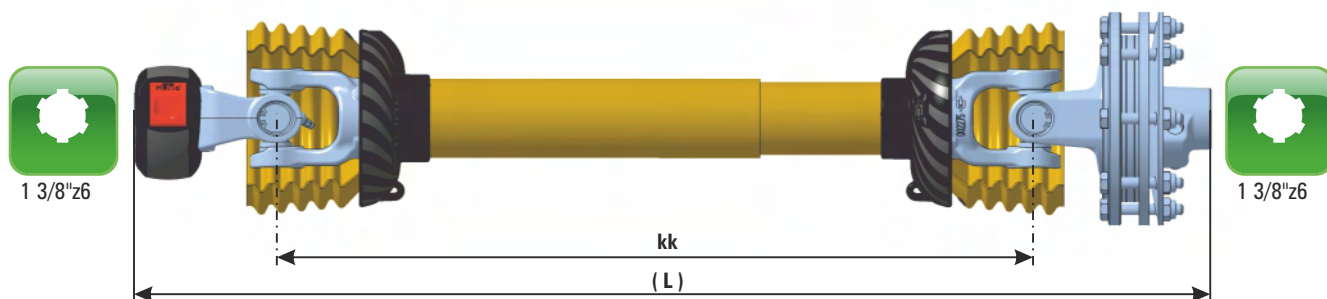

ARTIKEL	OZNAKA	DELOVNA DOLŽINA KARDANSKE GREDI		EAN 13 ČRTNA KODA	EAN 13 ČRTNA KODA
		priporočena L	maksimalna L		
006800	C Line 4 TS 800Nm kk510 (760)	925	960	3831111017536	
006802	C Line 4 TS 800Nm kk560 (810)	1000	1060	3831111017550	
006803	C Line 4 TS 800Nm kk610 (860)	1075	1160	3831111017567	
006804	C Line 4 TS 800Nm kk660 (910)	1150	1260	3831111017574	
006805	C Line 4 TS 800Nm kk710 (960)	1225	1358	3831111017581	
006807	C Line 4 TS 800Nm kk760 (1010)	1300	1445	3831111017604	
006808	C Line 4 TS 800Nm kk810 (1060)	1375	1533	3831111017611	
006811	C Line 4 TS 800Nm kk860 (1110)	1450	1620	3831111017642	
006812	C Line 4 TS 800Nm kk910 (1160)	1525	1708	3831111017659	
006813	C Line 4 TS 800Nm kk960 (1210)	1600	1795	3831111017666	
006815	C Line 4 TS 800Nm kk1010 (1260)	1675	1883	3831111017697	
006816	C Line 4 TS 800Nm kk1110 (1360)	1800	1950	3831111017703	
006818	C Line 4 TS 800Nm kk1210 (1460)	1950	2195	3831111017727	
006819	C Line 4 TS 800Nm kk1310 (1560)	2100	2370	3831111017734	
006820	C Line 4 TS 800Nm kk1410 (1660)	2250	2545	3831111017741	



*Opcija



KARDANSKA GRED

C Line 6 BR+

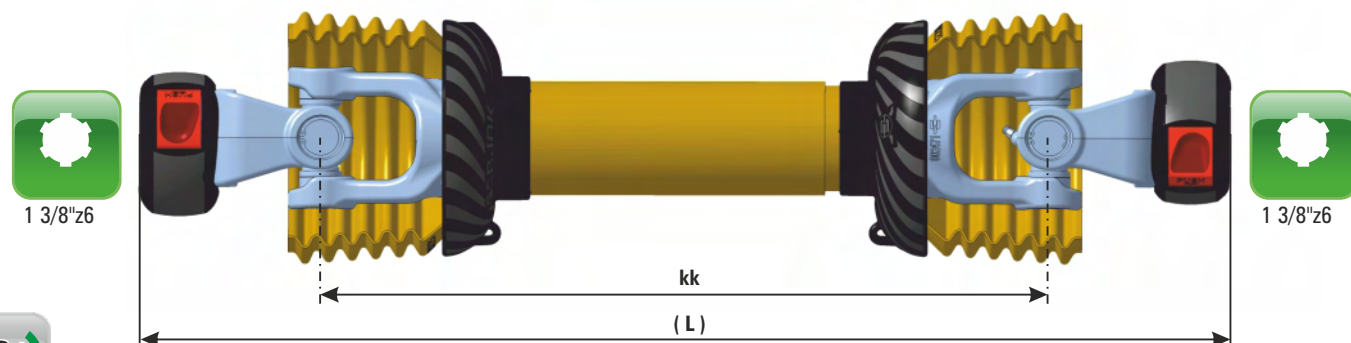

ARTIKEL	OZNAKA	DELOVNA DOLŽINA KARDANSKE GREDI		EAN 13 ČRTNA KODA	
		priporočena L	maksimalna L		
007205	C Line 6 BR+ kk560 (820)	993	1035	3831111021236	
007207	C Line 6 BR+ kk610 (870)	1068	1135	3831111021250	
007208	C Line 6 BR+ kk660 (920)	1143	1235	3831111021267	
007209	C Line 6 BR+ kk710 (970)	1218	1335	3831111021274	
007210	C Line 6 BR+ kk760 (1020)	1293	1429	3831111021281	
007211	C Line 6 BR+ kk810 (1070)	1368	1516	3831111021298	
007213	C Line 6 BR+ kk860 (1120)	1443	1604	3831111021304	
007214	C Line 6 BR+ kk910 (1170)	1518	1691	3831111021311	
007217	C Line 6 BR+ kk960 (1220)	1593	1779	3831111021328	
007219	C Line 6 BR+ kk1010 (1270)	1668	1866	3831111021335	
007220	C Line 6 BR+ kk1110 (1370)	1793	2004	3831111021342	
007221	C Line 6 BR+ kk1210 (1470)	1918	2141	3831111021359	
007222	C Line 6 BR+ kk1310 (1570)	2043	2279	3831111021366	
007223	C Line 6 BR+ kk1410 (1670)	2168	2416	3831111021373	

KARDANSKA GRED C Line 6 PS

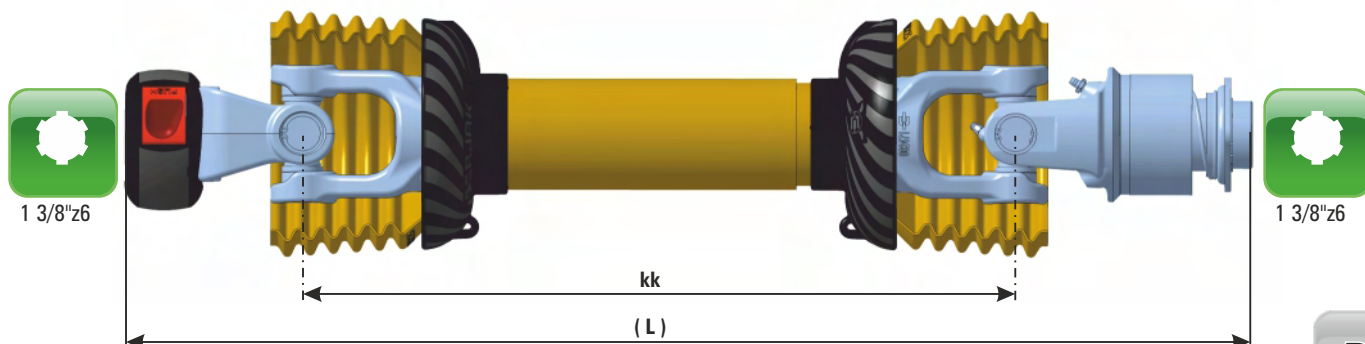

ARTIKEL	OZNAKA	DELOVNA DOLŽINA KARDANSKE GREDI		EAN 13 ČRTNA KODA
		priporočena L	maksimalna L	
006835	C Line 6 PS kk560 (860)	1033	1075	3831111017901
006836	C Line 6 PS kk610 (910)	1108	1175	3831111017918
006837	C Line 6 PS kk660 (960)	1183	1275	3831111017925
006839	C Line 6 PS kk710 (1010)	1258	1375	3831111017949
006851	C Line 6 PS kk760 (1060)	1333	1469	3831111018076
006852	C Line 6 PS kk810 (1110)	1408	1556	3831111018083
006853	C Line 6 PS kk860 (1160)	1483	1644	3831111018090
006854	C Line 6 PS kk910 (1210)	1558	1731	3831111018106
006855	C Line 6 PS kk960 (1260)	1633	1819	3831111018113
006856	C Line 6 PS kk1010 (1310)	1708	1906	3831111018120
006857	C Line 6 PS kk1110 (1410)	1833	2044	3831111018137
006859	C Line 6 PS kk1210 (1510)	1958	2181	3831111018151
006860	C Line 6 PS kk1310 (1610)	2083	2319	3831111018168
006861	C Line 6 PS kk1410 (1710)	2208	2456	3831111018618



*Opcija



KARDANSKA GRED C Line 6 PSL

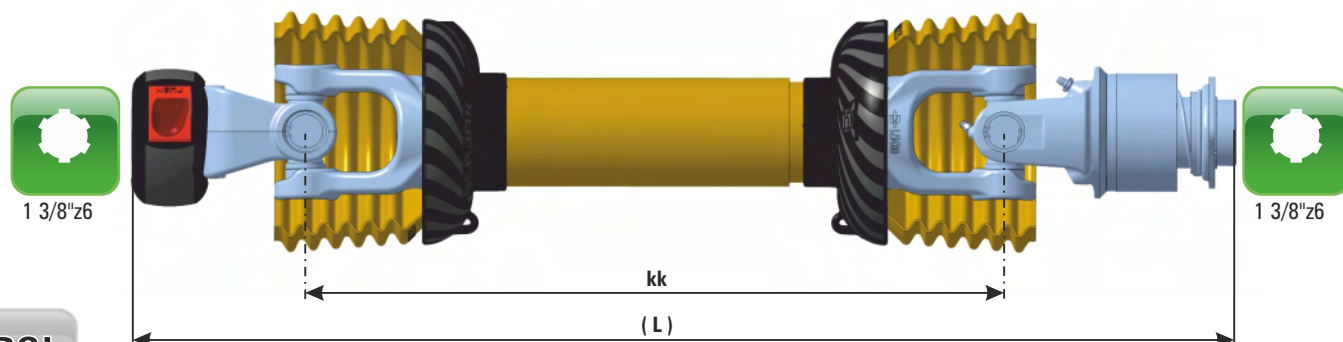

PSL
52 kW

6

25°

max.
1000
RPM

ARTIKEL	OZNAKA	DELOVNA DOLŽINA KARDANSKE GREDI		EAN 13 ČRTNA KODA	
		priporočena L	maksimalna L		
006864	C Line 6 PSL kk560 (860)	1033	1075	3831111018649	
006867	C Line 6 PSL kk610 (910)	1108	1175	3831111018670	
006868	C Line 6 PSL kk660 (960)	1183	1275	3831111018687	
006870	C Line 6 PSL kk710 (1010)	1258	1375	3831111018700	
006872	C Line 6 PSL kk760 (1060)	1333	1469	3831111018724	
006876	C Line 6 PSL kk810 (1110)	1408	1556	3831111018762	
006878	C Line 6 PSL kk860 (1160)	1483	1644	3831111018786	
006881	C Line 6 PSL kk910 (1210)	1558	1731	3831111018816	
006883	C Line 6 PSL kk960 (1260)	1633	1819	3831111018830	
006885	C Line 6 PSL kk1010 (1310)	1708	1906	3831111018854	
006887	C Line 6 PSL kk1110 (1410)	1833	2044	3831111018878	
006888	C Line 6 PSL kk1210 (1510)	1958	2181	3831111018885	
006892	C Line 6 PSL kk1310 (1610)	2083	2319	3831111018915	
006893	C Line 6 PSL kk1410 (1710)	2208	2456	3831111018922	

KARDANSKA GRED C Line 6 VS1 1200Nm

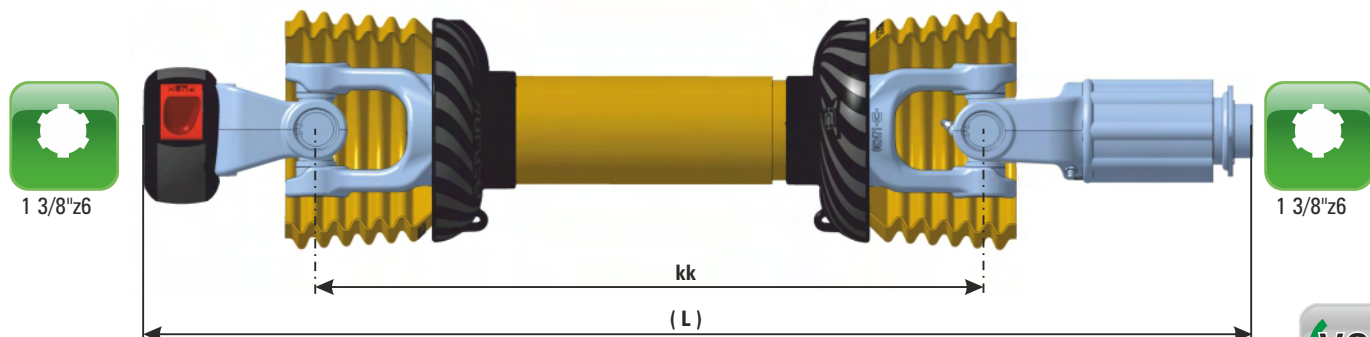

ARTIKEL	OZNAKA	DELOVNA DOLŽINA KARDANSKE GREDI		EAN 13 ČRTNA KODA	BARCODE
		priporočena L	maksimalna L		
006845	C Line 6 VS1 1200Nm kk560 (890)	1063	1105	3831111018014	
006846	C Line 6 VS1 1200Nm kk610 (940)	1138	1205	3831111018021	
006847	C Line 6 VS1 1200Nm kk660 (990)	1213	1305	3831111018038	
006848	C Line 6 VS1 1200Nm kk710 (1040)	1288	1405	3831111018045	
006849	C Line 6 VS1 1200Nm kk760 (1090)	1363	1499	3831111018052	
006850	C Line 6 VS1 1200Nm kk810 (1140)	1438	1586	3831111018069	
006863	C Line 6 VS1 1200Nm kk860 (1190)	1513	1674	3831111018632	
006866	C Line 6 VS1 1200Nm kk910 (1240)	1588	1761	3831111018663	
006869	C Line 6 VS1 1200Nm kk960 (1290)	1663	1849	3831111018694	
006871	C Line 6 VS1 1200Nm kk1010 (1340)	1738	1936	3831111018717	
006874	C Line 6 VS1 1200Nm kk1110 (1440)	1863	2074	3831111018748	
006877	C Line 6 VS1 1200Nm kk1210 (1540)	1988	2211	3831111018779	
006880	C Line 6 VS1 1200Nm kk1310 (1640)	2113	2349	3831111018809	
006884	C Line 6 VS1 1200Nm kk1410 (1740)	2238	2486	3831111018847	



KARDANSKA GRED

C Line 6 VS1 1500Nm

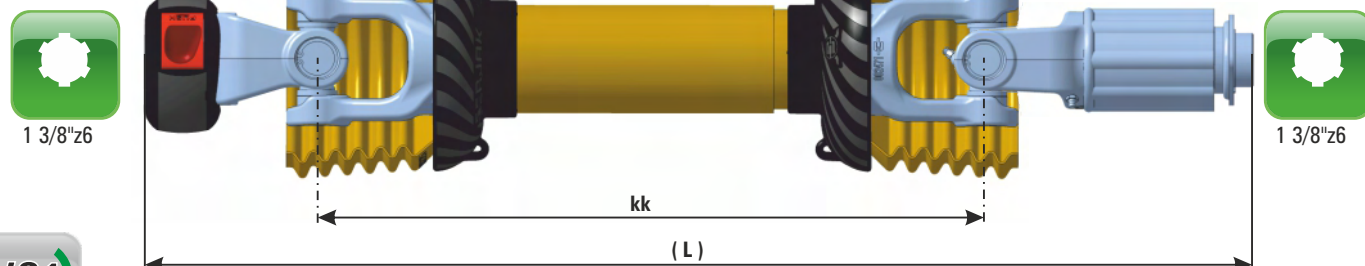

ARTIKEL	OZNAKA	DELOVNA DOLŽINA KARDANSKE GREDI		EAN 13 ČRTNA KODA	
		priporočena L	maksimalna L		
006901	C Line 6 VS1 1500Nm kk560 (910)	1083	1125	3831111018991	
006904	C Line 6 VS1 1500Nm kk610 (960)	1158	1225	3831111019028	
006906	C Line 6 VS1 1500Nm kk660 (1010)	1233	1325	3831111019042	
006908	C Line 6 VS1 1500Nm kk710 (1060)	1308	1425	3831111019066	
006910	C Line 6 VS1 1500Nm kk760 (1110)	1383	1519	3831111019080	
006913	C Line 6 VS1 1500Nm kk810 (1160)	1458	1606	3831111019110	
006915	C Line 6 VS1 1500Nm kk860 (1210)	1533	1694	3831111019134	
006918	C Line 6 VS1 1500Nm kk910 (1260)	1608	1781	3831111019165	
006922	C Line 6 VS1 1500Nm kk960 (1310)	1683	1869	3831111019202	
006927	C Line 6 VS1 1500Nm kk1010 (1360)	1758	1956	3831111019257	
006932	C Line 6 VS1 1500Nm kk1110 (1460)	1883	2094	3831111019301	
006937	C Line 6 VS1 1500Nm kk1210 (1560)	2008	2231	3831111019349	
006940	C Line 6 VS1 1500Nm kk1310 (1660)	2133	2369	3831111019370	
006942	C Line 6 VS1 1500Nm kk1410 (1760)	2258	2506	3831111019394	

KARDANSKA GRED C Line 6 ST 1700Nm

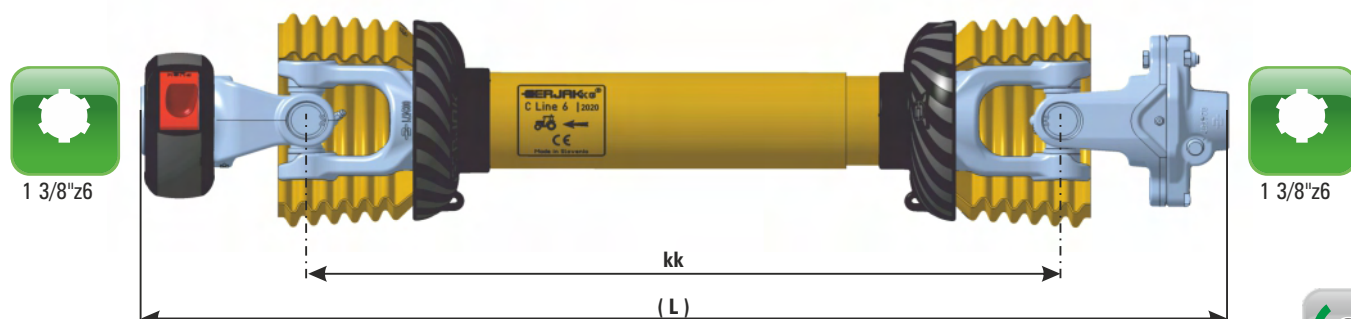

ARTIKEL	OZNAKA	DELOVNA DOLŽINA KARDANSKE GREDI		EAN 13 ČRTNA KODA	BARČNA KODA
		priporočena L	maksimalna L		
028471	C Line 6 ST 1700Nm kk560 (830)	1003	1045	3838433015691	
028472	C Line 6 ST 1700Nm kk610 (880)	1078	1145	3838433015707	
027187	C Line 6 ST 1700Nm kk660 (930)	1153	1245	3838433012430	
028473	C Line 6 ST 1700Nm kk710 (980)	1228	1345	3838433015714	
028474	C Line 6 ST 1700Nm kk760 (1030)	1303	1439	3838433015721	
026946	C Line 6 ST 1700Nm kk810 (1080)	1378	1526	3838433012331	
028475	C Line 6 ST 1700Nm kk860 (1130)	1453	1614	3838433015738	
028476	C Line 6 ST 1700Nm kk910 (1180)	1528	1701	3838433015745	
028477	C Line 6 ST 1700Nm kk960 (1230)	1603	1789	3838433015752	
025628	C Line 6 ST 1700Nm kk1010 (1280)	1678	1876	3838433011068	
028478	C Line 6 ST 1700Nm kk1110 (1380)	1803	2014	3838433015769	
028479	C Line 6 ST 1700Nm kk1210 (1480)	1928	2151	3838433015776	
028480	C Line 6 ST 1700Nm kk1310 (1580)	2053	2289	3838433015783	
028481	C Line 6 ST 1700Nm kk1410 (1680)	2178	2426	3838433015790	

KARDANSKA GRED

C Line 6 ST 2000Nm

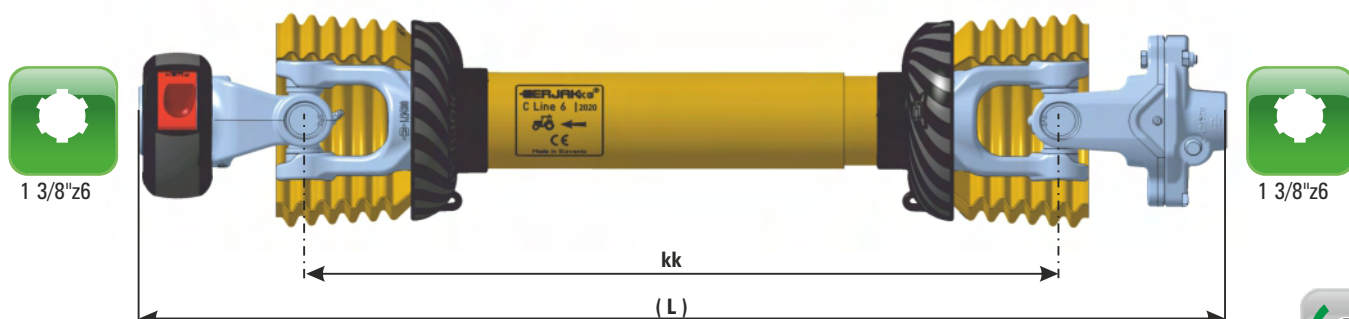

ARTIKEL	OZNAKA	DELOVNA DOLŽINA KARDANSKE GREDI		EAN 13 ČRTNA KODA	BARCODE
		priporočena L	maksimalna L		
028650	C Line 6 ST 2000Nm kk560 (830)	1003	1045	3838433017480	
028651	C Line 6 ST 2000Nm kk610 (880)	1078	1145	3838433017497	
028652	C Line 6 ST 2000Nm kk660 (930)	1153	1245	3838433017503	
028653	C Line 6 ST 2000Nm kk710 (980)	1228	1345	3838433017510	
028654	C Line 6 ST 2000Nm kk760 (1030)	1303	1439	3838433017527	
028655	C Line 6 ST 2000Nm kk810 (1080)	1378	1526	3838433017534	
028656	C Line 6 ST 2000Nm kk860 (1130)	1453	1614	3838433017541	
028657	C Line 6 ST 2000Nm kk910 (1180)	1528	1701	3838433017558	
028658	C Line 6 ST 2000Nm kk960 (1230)	1603	1789	3838433017565	
025932	C Line 6 ST 2000Nm kk1010 (1280)	1678	1876	3838433011280	
028659	C Line 6 ST 2000Nm kk1110 (1380)	1803	2014	3838433017572	
028660	C Line 6 ST 2000Nm kk1210 (1480)	1928	2151	3838433017589	
028661	C Line 6 ST 2000Nm kk1310 (1580)	2053	2289	3838433017596	
028662	C Line 6 ST 2000Nm kk1410 (1680)	2178	2426	3838433017602	

KARDANSKA GRED C Line 6 ST 2400Nm

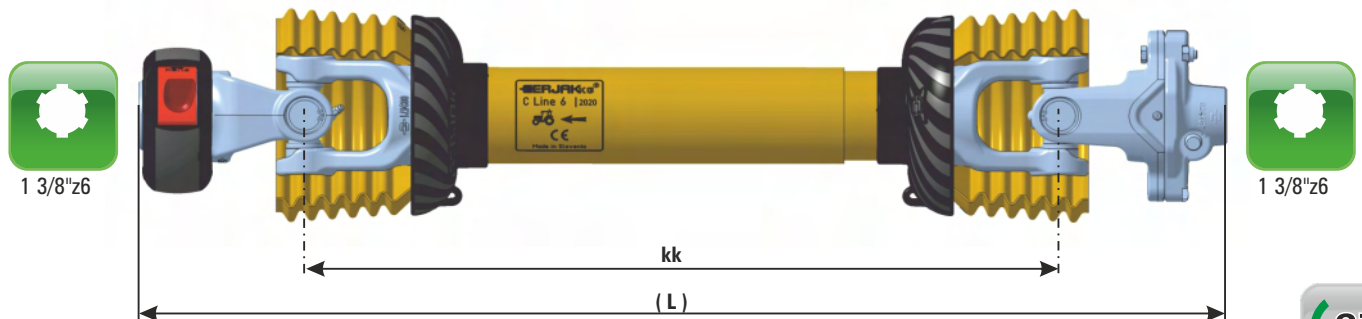

ARTIKEL	OZNAKA	DELOVNA DOLŽINA KARDANSKE GREDI		EAN 13 ČRTNA KODA	EAN 13 ČRTNA KODA
		priporočena L	maksimalna L		
028831	C Line 6 ST 2400Nm kk560 (830)	1003	1045	3838433019293	
028832	C Line 6 ST 2400Nm kk610 (880)	1078	1145	3838433019309	
028833	C Line 6 ST 2400Nm kk660 (930)	1153	1245	3838433019316	
028834	C Line 6 ST 2400Nm kk710 (980)	1228	1345	3838433019323	
028835	C Line 6 ST 2400Nm kk760 (1030)	1303	1439	3838433019330	
028836	C Line 6 ST 2400Nm kk810 (1080)	1378	1526	3838433019347	
028837	C Line 6 ST 2400Nm kk860 (1130)	1453	1614	3838433019354	
028838	C Line 6 ST 2400Nm kk910 (1180)	1528	1701	3838433019361	
028839	C Line 6 ST 2400Nm kk960 (1230)	1603	1789	3838433019378	
028840	C Line 6 ST 2400Nm kk1010 (1280)	1678	1876	3838433019385	
028841	C Line 6 ST 2400Nm kk1110 (1380)	1803	2014	3838433019392	
028842	C Line 6 ST 2400Nm kk1210 (1480)	1928	2151	3838433019408	
028843	C Line 6 ST 2400Nm kk1310 (1580)	2053	2289	3838433019415	
028844	C Line 6 ST 2400Nm kk1410 (1680)	2178	2426	3838433019422	

KARDANSKA GRED

C Line 6 ST 2700Nm

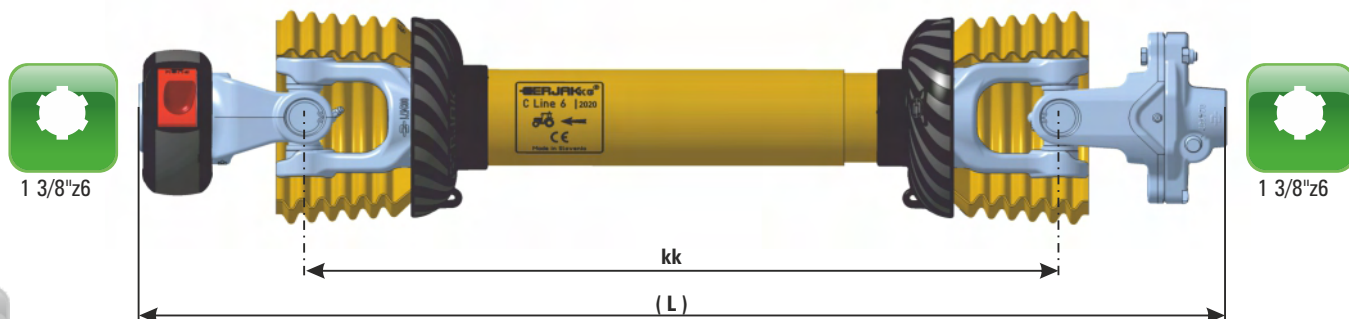

ARTIKEL	OZNAKA	DELOVNA DOLŽINA KARDANSKE GREDI		EAN 13 ČRTNA KODA	EAN 13 ČRTNA KODA
		priporočena L	maksimalna L		
006951	C Line 6 ST 2700Nm kk560 (830)	1003	1045	3831111019486	
006953	C Line 6 ST 2700Nm kk610 (880)	1078	1145	3831111019509	
006955	C Line 6 ST 2700Nm kk660 (930)	1153	1245	3831111019523	
006956	C Line 6 ST 2700Nm kk710 (980)	1228	1345	3831111019530	
006958	C Line 6 ST 2700Nm kk760 (1030)	1303	1439	3831111019554	
006960	C Line 6 ST 2700Nm kk810 (1080)	1378	1526	3831111019578	
006961	C Line 6 ST 2700Nm kk860 (1130)	1453	1614	3831111019585	
006963	C Line 6 ST 2700Nm kk910 (1180)	1528	1701	3831111019608	
006965	C Line 6 ST 2700Nm kk960 (1230)	1603	1789	3831111019622	
006966	C Line 6 ST 2700Nm kk1010 (1280)	1678	1876	3831111019639	
006968	C Line 6 ST 2700Nm kk1110 (1380)	1803	2014	3831111019653	
006969	C Line 6 ST 2700Nm kk1210 (1480)	1928	2151	3831111019660	
006971	C Line 6 ST 2700Nm kk1310 (1580)	2053	2289	3831111019684	
006973	C Line 6 ST 2700Nm kk1410 (1680)	2178	2426	3831111019707	

KARDANSKA GRED C Line 6 TS 1200Nm

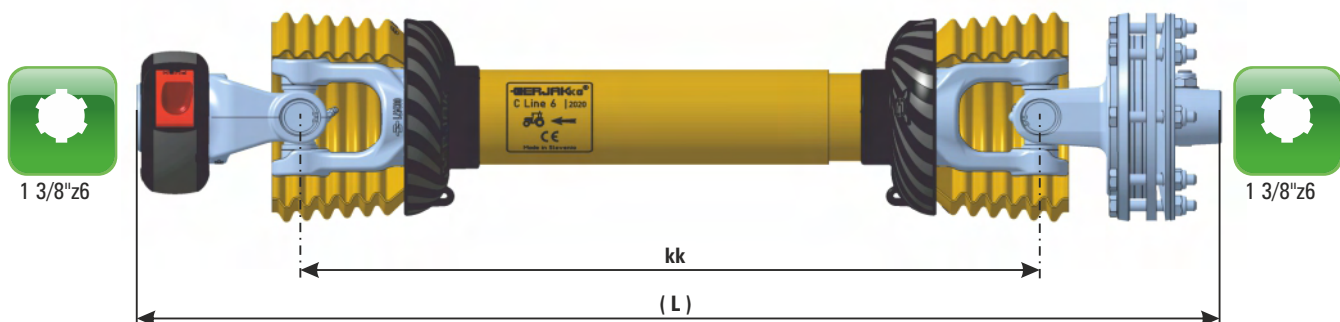

ARTIKEL	OZNAKA	DELOVNA DOLŽINA KARDANSKE GREDI		EAN 13 ČRTNA KODA
		priporočena L	maksimalna L	
006903	C Line 6 TS 1200Nm kk560 (850)	1023	1065	3831111019011
006907	C Line 6 TS 1200Nm kk610 (900)	1098	1165	3831111019059
006909	C Line 6 TS 1200Nm kk660 (950)	1173	1265	3831111019073
006912	C Line 6 TS 1200Nm kk710 (1000)	1248	1365	3831111019103
006914	C Line 6 TS 1200Nm kk760 (1050)	1323	1459	3831111019127
006917	C Line 6 TS 1200Nm kk810 (1100)	1398	1546	3831111019158
006920	C Line 6 TS 1200Nm kk860 (1150)	1473	1634	3831111019189
006923	C Line 6 TS 1200Nm kk910 (1200)	1548	1721	3831111019219
006925	C Line 6 TS 1200Nm kk960 (1250)	1623	1809	3831111019233
006929	C Line 6 TS 1200Nm kk1010 (1300)	1698	1896	3831111019271
006933	C Line 6 TS 1200Nm kk1110 (1400)	1823	2034	3831111019318
006936	C Line 6 TS 1200Nm kk1210 (1500)	1948	2171	3831111019332
006939	C Line 6 TS 1200Nm kk1310 (1600)	2073	2309	3831111019363
006944	C Line 6 TS 1200Nm kk1410 (1700)	2198	2446	3831111019417

*Opcija **PS** + **TS**

KARDANSKA GRED

C Line 8 BR+

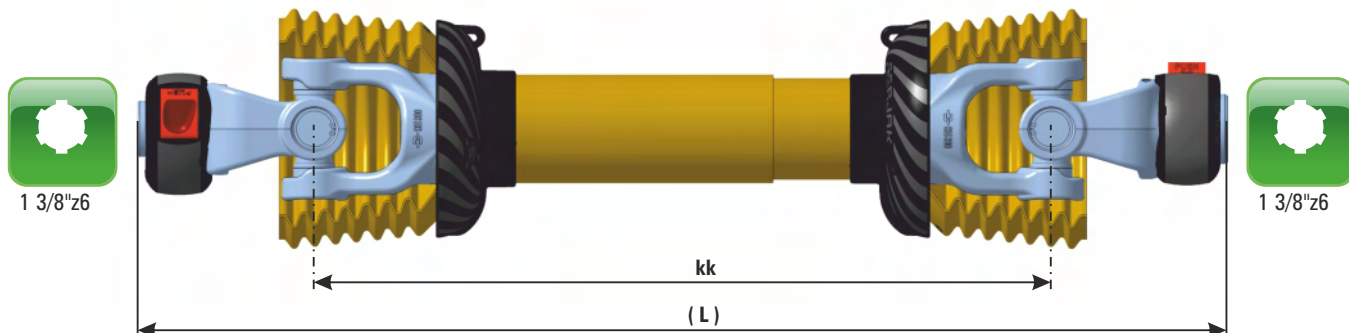

ARTIKEL	OZNAKA	DELOVNA DOLŽINA KARDANSKE GREDI		EAN 13 ČRTNA KODA	
		priporočena L	maksimalna L		
010706	C Line 8 BR+ kk660 (960)	1160	1220	3831111030283	
010708	C Line 8 BR+ kk710 (1010)	1240	1320	3831111030313	
010709	C Line 8 BR+ kk760 (1060)	1310	1420	3831111030320	
010710	C Line 8 BR+ kk810 (1110)	1390	1520	3831111030337	
010711	C Line 8 BR+ kk860 (1160)	1460	1610	3831111030344	
010712	C Line 8 BR+ kk910 (1210)	1540	1700	3831111030351	
010713	C Line 8 BR+ kk960 (1260)	1620	1790	3831111030368	
010714	C Line 8 BR+ kk1010 (1310)	1690	1870	3831111030375	
010715	C Line 8 BR+ kk1110 (1410)	1840	2050	3831111030382	
010716	C Line 8 BR+ kk1210 (1510)	1990	2220	3831111030399	
010717	C Line 8 BR+ kk1310 (1610)	2140	2400	3831111030405	
010718	C Line 8 BR+ kk1410 (1710)	2290	2570	3831111030412	

KARDANSKA GRED C Line 8 PS

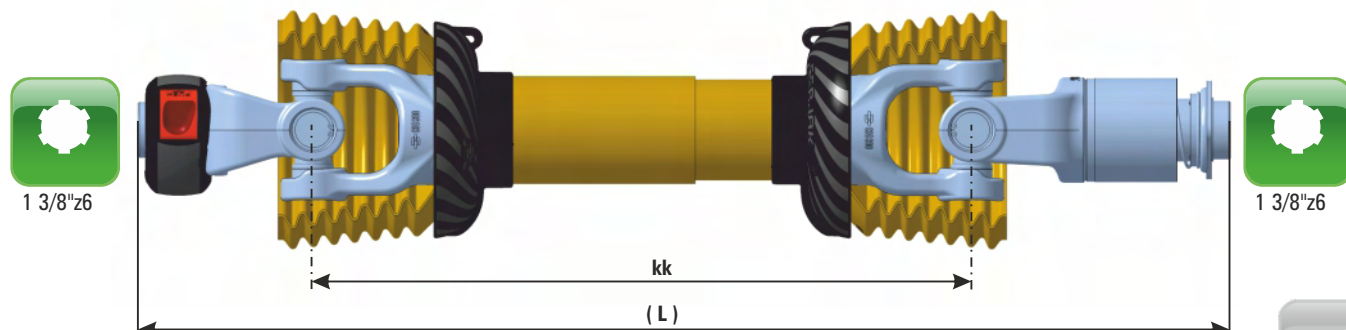

ARTIKEL	OZNAKA	DELOVNA DOLŽINA KARDANSKE GREDI		EAN 13 ČRTNA KODA	EAN 13 ČRTNA KODA
		priporočena L	maksimalna L		
010728	C Line 8 PS kk660 (1030)	1230	1290	3831111030474	
010789	C Line 8 PS kk710 (1080)	1310	1390	3831111031075	
010790	C Line 8 PS kk760 (1130)	1380	1490	3831111031082	
010791	C Line 8 PS kk810 (1180)	1460	1590	3831111031099	
010792	C Line 8 PS kk860 (1230)	1530	1680	3831111033956	
010793	C Line 8 PS kk910 (1280)	1610	1770	3831111031105	
010794	C Line 8 PS kk960 (1330)	1690	1860	3831111031112	
010795	C Line 8 PS kk1010 (1380)	1760	1940	3831111031129	
010796	C Line 8 PS kk1110 (1480)	1910	2120	3831111031136	
010797	C Line 8 PS kk1210 (1580)	2060	2290	3831111031143	
010798	C Line 8 PS kk1310 (1680)	2210	2470	3831111031150	
010799	C Line 8 PS kk1410 (1780)	2360	2640	3831111031167	

*Opcija



KARDANSKA GRED

C Line 8 PSL

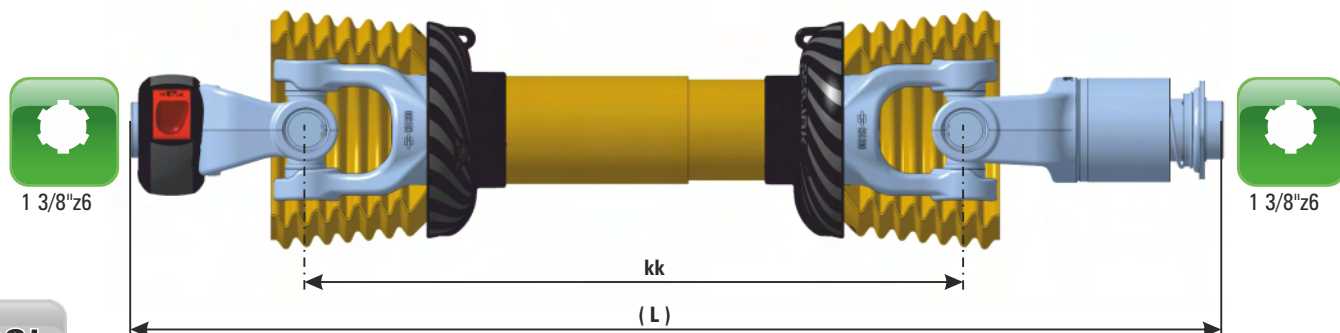

ARTIKEL	OZNAKA	DELOVNA DOLŽINA KARDANSKE GREDI		EAN 13 ČRTNA KODA	
		priporočena L	maksimalna L		
012504	C Line 8 PSL kk660 (1030)	1230	1290	3831111040541	
012505	C Line 8 PSL kk710 (1080)	1310	1390	3831111040558	
012506	C Line 8 PSL kk760 (1130)	1380	1490	3831111040565	
012507	C Line 8 PSL kk810 (1180)	1460	1590	3831111040572	
012508	C Line 8 PSL kk860 (1230)	1530	1680	3831111040589	
012509	C Line 8 PSL kk910 (1280)	1610	1770	3831111040596	
012510	C Line 8 PSL kk960 (1330)	1690	1860	3831111040602	
012511	C Line 8 PSL kk1010 (1380)	1760	1940	3831111040619	
012512	C Line 8 PSL kk1110 (1480)	1910	2120	3831111040626	
012513	C Line 8 PSL kk1210 (1580)	2060	2290	3831111040633	
012514	C Line 8 PSL kk1310 (1680)	2210	2470	3831111040640	
012515	C Line 8 PSL kk1410 (1780)	2360	2640	3831111040657	

KARDANSKA GRED C Line 8 VS1 1500Nm

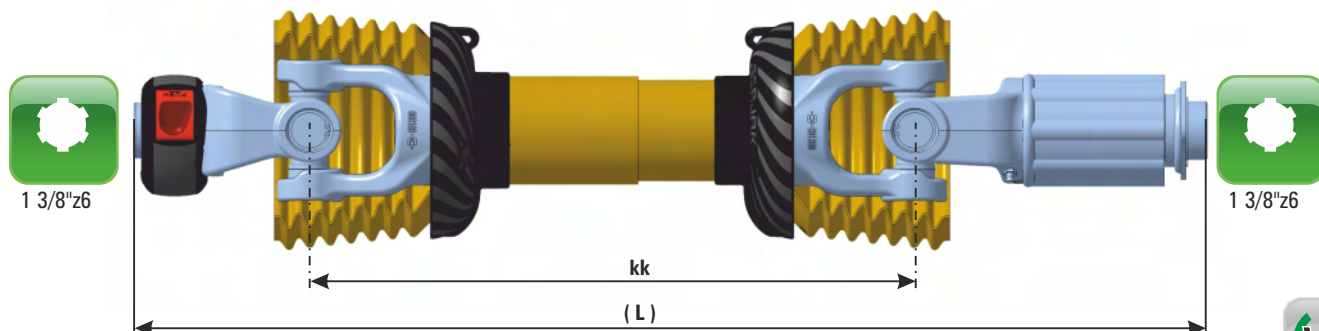

ARTIKEL	OZNAKA	DELOVNA DOLŽINA KARDANSKE GREDEI		EAN 13 ČRTNA KODA	EAN 13 ČRTNA KODA
		priporočena L	maksimalna L		
019100	C Line 8 VS1 1500Nm kk660 (1050)	1250	1310	3831111097057	
019977	C Line 8 VS1 1500Nm kk710 (1100)	1330	1410	3838433000970	
019978	C Line 8 VS1 1500Nm kk760 (1150)	1400	1510	3838433000987	
019979	C Line 8 VS1 1500Nm kk810 (1200)	1480	1610	3838433000994	
019980	C Line 8 VS1 1500Nm kk860 (1250)	1550	1700	3838433001007	
019981	C Line 8 VS1 1500Nm kk910 (1300)	1630	1790	3838433001014	
019984	C Line 8 VS1 1500Nm kk960 (1350)	1710	1880	3838433001045	
019985	C Line 8 VS1 1500Nm kk1010 (1400)	1780	1960	3838433001052	
019986	C Line 8 VS1 1500Nm kk1110 (1500)	1930	2140	3838433001069	
019987	C Line 8 VS1 1500Nm kk1210 (1600)	2080	2310	3838433001076	
019988	C Line 8 VS1 1500Nm kk1310 (1700)	2230	2490	3838433001083	
019989	C Line 8 VS1 1500Nm kk1410 (1800)	2380	2660	3838433001090	

KARDANSKA GRED

C Line 8 ST 2400Nm

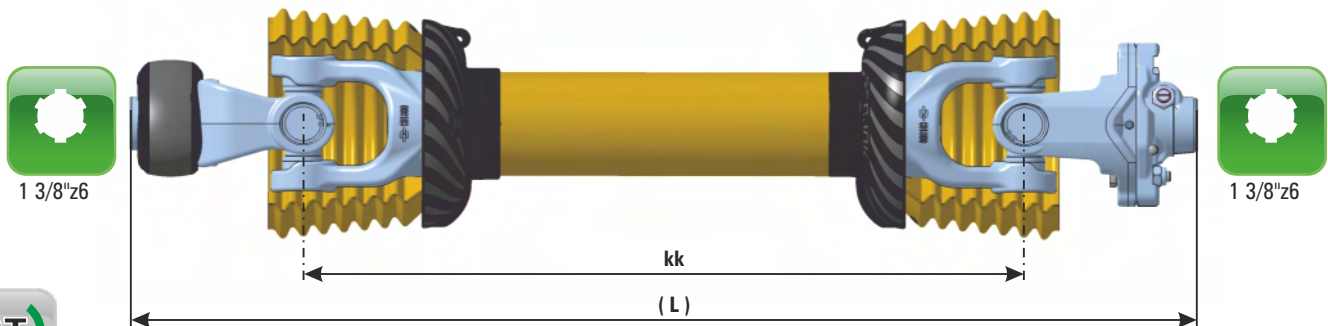

ARTIKEL	OZNAKA	DELOVNA DOLŽINA KARDANSKE GREDI		EAN 13 ČRTNA KODA	
		priporočena L	maksimalna L		
027188	C Line 8 ST 2400Nm kk660 (960)	1160	1220	3838433012447	
029177	C Line 8 ST 2400Nm kk710 (1010)	1240	1320	3838433022750	
029178	C Line 8 ST 2400Nm kk760 (1060)	1310	1420	3838433022767	
029179	C Line 8 ST 2400Nm kk810 (1110)	1390	1520	3838433022774	
029180	C Line 8 ST 2400Nm kk860 (1160)	1460	1610	3838433022781	
029181	C Line 8 ST 2400Nm kk910 (1210)	1540	1700	3838433022798	
027247	C Line 8 ST 2400Nm kk960 (1260)	1620	1790	3838433012485	
029182	C Line 8 ST 2400Nm kk1010 (1310)	1690	1870	3838433022804	
029183	C Line 8 ST 2400Nm kk1110 (1410)	1840	2050	3838433022811	
029184	C Line 8 ST 2400Nm kk1210 (1510)	1990	2220	3838433022828	
029185	C Line 8 ST 2400Nm kk1310 (1610)	2140	2400	3838433022835	
029186	C Line 8 ST 2400Nm kk1410 (1710)	2290	2570	3838433022842	

KARDANSKA GRED C Line 8 ST 2700Nm

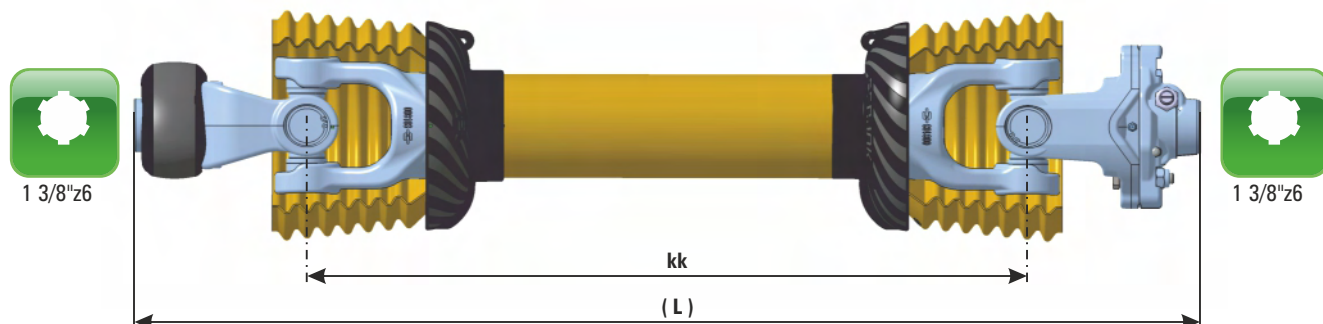

ARTIKEL	OZNAKA	DELOVNA DOLŽINA KARDANSKE GREDI		EAN 13 ČRTNA KODA	
		priporočena L	maksimalna L		
029331	C Line 8 ST 2700Nm kk660 (960)	1160	1220	3838433024297	
029332	C Line 8 ST 2700Nm kk710 (1010)	1240	1320	3838433024303	
029333	C Line 8 ST 2700Nm kk760 (1060)	1310	1420	3838433024310	
029334	C Line 8 ST 2700Nm kk810 (1110)	1390	1520	3838433024327	
029335	C Line 8 ST 2700Nm kk860 (1160)	1460	1610	3838433024334	
029336	C Line 8 ST 2700Nm kk910 (1210)	1540	1700	3838433024341	
029337	C Line 8 ST 2700Nm kk960 (1260)	1620	1790	3838433024358	
029338	C Line 8 ST 2700Nm kk1010 (1310)	1690	1870	3838433024365	
029339	C Line 8 ST 2700Nm kk1110 (1410)	1840	2050	3838433024372	
029340	C Line 8 ST 2700Nm kk1210 (1510)	1990	2220	3838433024389	
029341	C Line 8 ST 2700Nm kk1310 (1610)	2140	2400	3838433024396	
029342	C Line 8 ST 2700Nm kk1410 (1710)	2290	2570	3838433024402	

KARDANSKA GRED



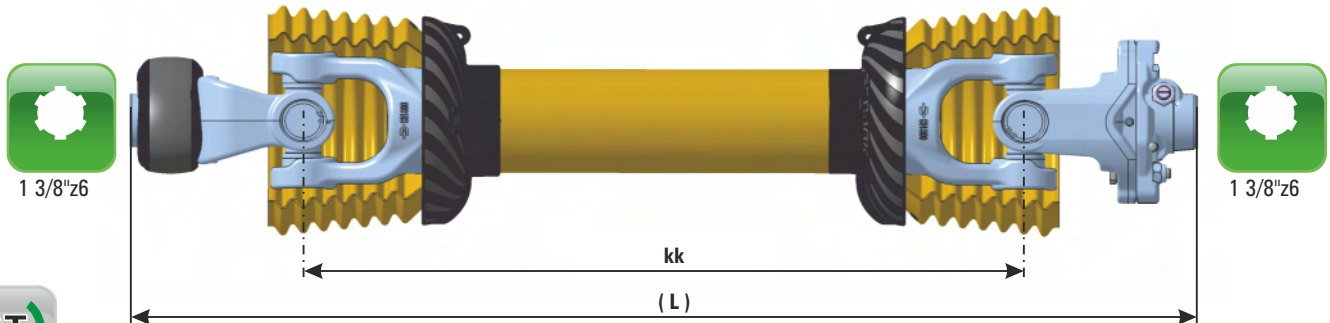





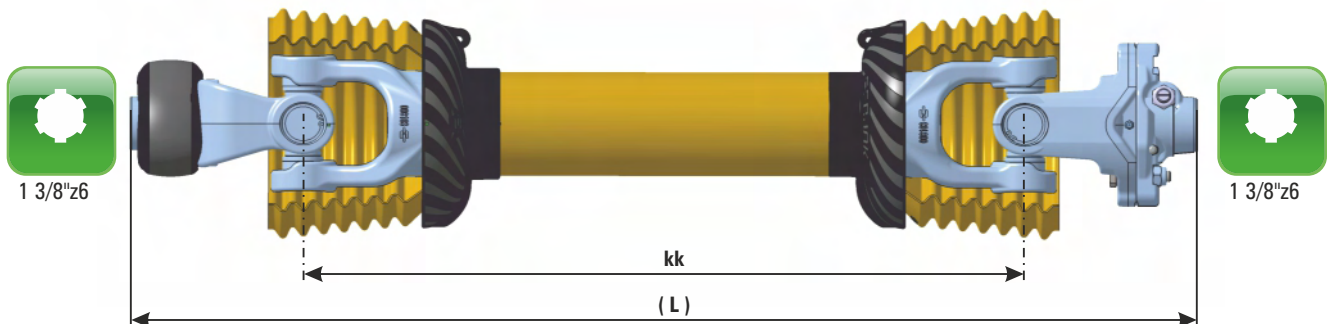



C Line 8 ST 3000Nm



ARTIKEL	OZNAKA	DELOVNA DOLŽINA KARDANSKE GREDI		EAN 13 ČRTNA KODA	
		priporočena L	maksimalna L		
011725	C Line 8 ST 3000Nm kk660 (960)	1160	1220	3831111035929	
019137	C Line 8 ST 3000Nm kk710 (1010)	1240	1320	3831111097132	
019138	C Line 8 ST 3000Nm kk760 (1060)	1310	1420	3831111097149	
019139	C Line 8 ST 3000Nm kk810 (1110)	1390	1520	3831111097156	
011723	C Line 8 ST 3000Nm kk860 (1160)	1460	1610	3831111035905	
019140	C Line 8 ST 3000Nm kk910 (1210)	1540	1700	3831111097163	
019141	C Line 8 ST 3000Nm kk960 (1260)	1620	1790	3831111097170	
019142	C Line 8 ST 3000Nm kk1010 (1310)	1690	1870	3831111097187	
011726	C Line 8 ST 3000Nm kk1110 (1410)	1840	2050	3831111035936	
011747	C Line 8 ST 3000Nm kk1210 (1510)	1990	2220	3831111036001	
019143	C Line 8 ST 3000Nm kk1310 (1610)	2140	2400	3831111097194	
019144	C Line 8 ST 3000Nm kk1410 (1710)	2290	2570	3831111097200	

KARDANSKA GRED C Line 8 ST 3500Nm



ARTIKEL	OZNAKA	DELOVNA DOLŽINA KARDANSKE GREDI		EAN 13 ČRTNA KODA
		priporočena L	maksimalna L	
010742	C Line 8 ST 3500Nm kk660 (960)	1160	1220	3831111030610 
010945	C Line 8 ST 3500Nm kk710 (1010)	1240	1320	3831111032546 
010947	C Line 8 ST 3500Nm kk760 (1060)	1310	1420	3831111032560 
010948	C Line 8 ST 3500Nm kk810 (1110)	1390	1520	3831111032577 
010949	C Line 8 ST 3500Nm kk860 (1160)	1460	1610	3831111034038 
010950	C Line 8 ST 3500Nm kk910 (1210)	1540	1700	3831111032584 
010951	C Line 8 ST 3500Nm kk960 (12600)	1620	1790	3831111032591 
010952	C Line 8 ST 3500Nm kk1010 (1310)	1690	1870	3831111032607 
010953	C Line 8 ST 3500Nm kk1110 (1410)	1840	2050	3831111032614 
010954	C Line 8 ST 3500Nm kk1210 (1510)	1990	2220	3831111032621 
010955	C Line 8 ST 3500Nm kk1310 (1610)	2140	2400	3831111032638 
010957	C Line 8 ST 3500Nm kk1410 (1710)	2290	2570	3831111032652 

KARDANSKA GRED

C Line 8 TS 1800Nm

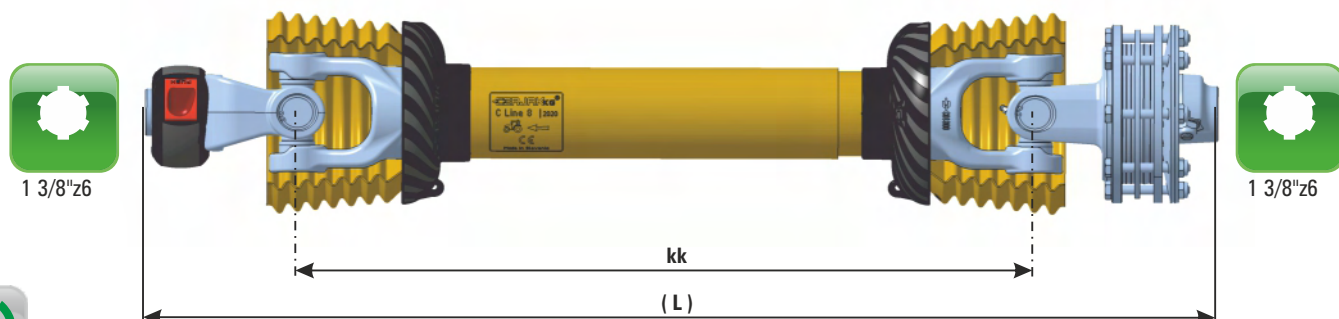

ARTIKEL	OZNAKA	DELOVNA DOLŽINA KARDANSKE GREDI		EAN 13 ČRTNA KODA	
		priporočena L	maksimalna L		
004185	C Line 8 TS 1800Nm kk660 (990)	1190	1250	3831111035318	
019233	C Line 8 TS 1800Nm kk710 (1040)	1270	1350	3831111098092	
019234	C Line 8 TS 1800Nm kk760 (1090)	1340	1450	3831111098108	
019235	C Line 8 TS 1800Nm kk810 (1140)	1420	1550	3831111098115	
019236	C Line 8 TS 1800Nm kk860 (1190)	1490	1640	3831111098122	
019237	C Line 8 TS 1800Nm kk910 (1240)	1570	1730	3831111098139	
019238	C Line 8 TS 1800Nm kk960 (1290)	1650	1820	3831111098146	
019239	C Line 8 TS 1800Nm kk1010 (1340)	1720	1900	3831111098153	
019240	C Line 8 TS 1800Nm kk1110 (1440)	1870	2080	3831111098160	
019241	C Line 8 TS 1800Nm kk1210 (1540)	2020	2250	3831111098177	
019242	C Line 8 TS 1800Nm kk1310 (1640)	2170	2430	3831111098184	
019243	C Line 8 TS 1800Nm kk1410 (1740)	2320	2600	3831111098191	

*Opcija



KARDANSKA GRED C Line 8 TS 2600Nm

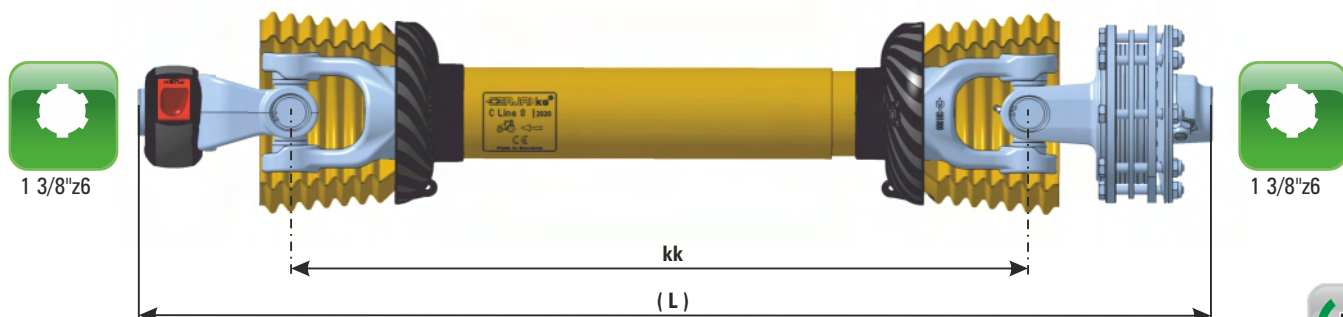

ARTIKEL	OZNAKA	DELOVNA DOLŽINA KARDANSKE GREDI		EAN 13 ČRTNA KODA
		priporočena L	maksimalna L	
010768	C Line 8 TS 2600Nm kk660 (990)	1190	1250	3831111030863
011903	C Line 8 TS 2600Nm kk710 (1040)	1270	1350	3831111037367
011904	C Line 8 TS 2600Nm kk760 (1090)	1340	1450	3831111037374
011905	C Line 8 TS 2600Nm kk810 (1140)	1420	1550	3831111037381
011908	C Line 8 TS 2600Nm kk860 (1190)	1490	1640	3831111037411
011906	C Line 8 TS 2600Nm kk910 (1240)	1570	1730	3831111037398
011907	C Line 8 TS 2600Nm kk960 (1290)	1650	1820	3831111037404
011909	C Line 8 TS 2600Nm kk1010 (1340)	1720	1900	3831111037428
011910	C Line 8 TS 2600Nm kk1110 (1440)	1870	2080	3831111037435
011911	C Line 8 TS 2600Nm kk1210 (1540)	2020	2250	3831111037442
011912	C Line 8 TS 2600Nm kk1310 (1640)	2170	2430	3831111037459
011913	C Line 8 TS 2600Nm kk1410 (1740)	2320	2600	3831111037466

*Opcija



ŠIROKOKOTNE KARDANSKE GREDI

ŠIROKOKOTNA KARDANSKA GRED C Line 4 DZ BR+

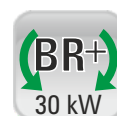
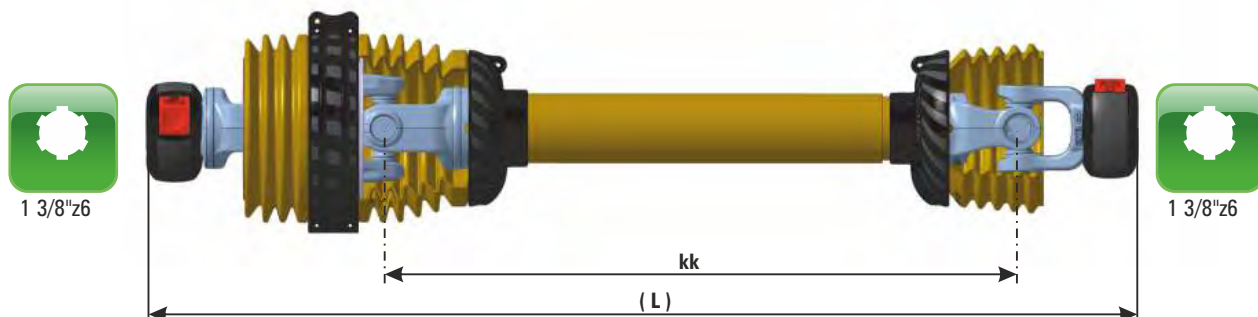

ARTIKEL	OZNAKA	DELOVNA DOLŽINA KARDANSKE GREDI		EAN 13 ČRTNA KODA
		priporočena L	maksimalna L	
013007	C Line 4 DZ BR+ kk710 (1040)	1305	1393	3831111043078
013016	C Line 4 DZ BR+ kk810 (1140)	1455	1560	3831111043160
013025	C Line 4 DZ BR+ kk910 (1240)	1605	1727	3831111043252
012962	C Line 4 DZ BR+ kk1010 (1340)	1755	1893	3831111042620
012971	C Line 4 DZ BR+ kk1210 (1540)	2055	2227	3831111042712
012980	C Line 4 DZ BR+ kk1410 (1740)	2355	2560	3831111042804

ŠIROKOKOTNA KARDANSKA GRED C Line 4 DZ DZ BR+

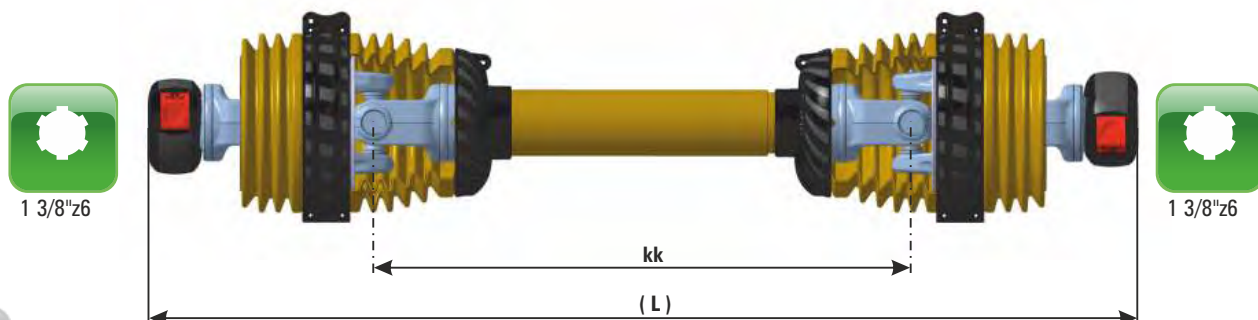

ARTIKEL	OZNAKA	DELOVNA DOLŽINA KARDANSKE GREDI		EAN 13 ČRTNA KODA	
		priporočena L	maksimalna L		
013220	C Line 4 DZ DZ BR+ kk710 (1150)	1415	1503	3831111045201	
013088	C Line 4 DZ DZ BR+ kk810 (1250)	1565	1670	3831111043887	
013097	C Line 4 DZ DZ BR+ kk910 (1350)	1715	1837	3831111043979	
013034	C Line 4 DZ DZ BR+ kk1010 (1450)	1865	2003	3831111043344	
013043	C Line 4 DZ DZ BR+ kk1210 (1650)	2165	2337	3831111043436	
013052	C Line 4 DZ DZ BR+ kk1410 (1850)	2465	2670	3831111043528	

ŠIROKOKOTNA KARDANSKA GRED C Line 4 DZ PS

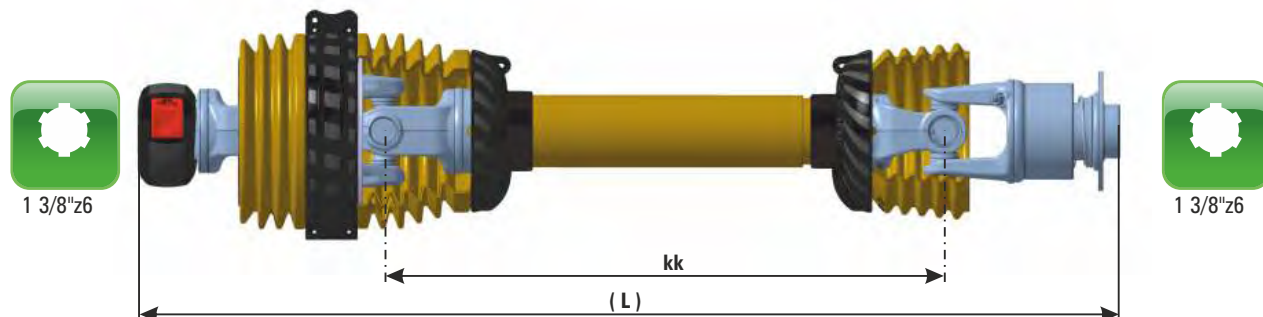

ARTIKEL	OZNAKA	DELOVNA DOLŽINA KARDANSKE GREDI		EAN 13 ČRTNA KODA
		priporočena L	maksimalna L	
013507	C Line 4 DZ PS kk710 (1090)	1355	1443	3831111048073
013516	C Line 4 DZ PS kk810 (1190)	1505	1610	3831111048165
013525	C Line 4 DZ PS kk910 (1290)	1655	1777	3831111048257
013462	C Line 4 DZ PS kk1010 (1390)	1805	1943	3831111047625
013471	C Line 4 DZ PS kk1210 (1590)	2105	2277	3831111047717
013480	C Line 4 DZ PS kk1410 (1790)	2405	2610	3831111047809



*Opcija



ŠIROKOKOTNA KARDANSKA GRED C Line 4 DZ VS 600Nm

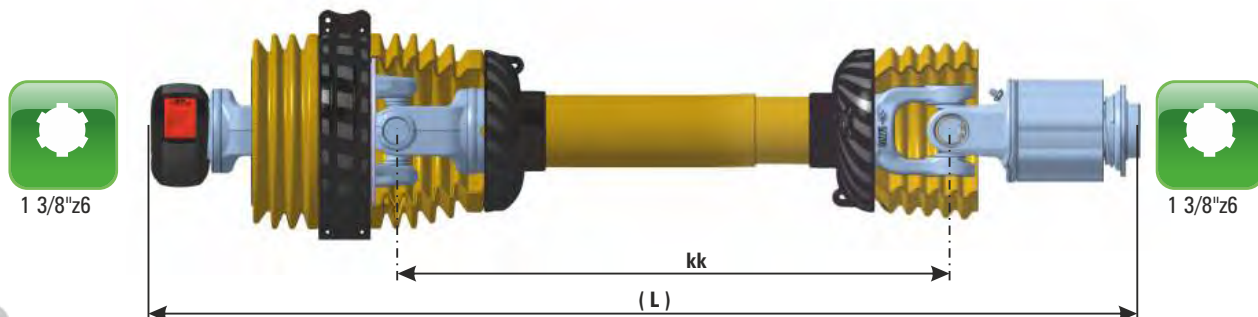

ARTIKEL	OZNAKA	DELOVNA DOLŽINA KARDANSKE GREDI		EAN 13 ČRTNA KODA	EAN 13 ČRTNA KODA
		priporočena L	maksimalna L		
013651	C Line 4 DZ VS 600Nm kk710 (1080)	1345	1433	3831111049513	
013660	C Line 4 DZ VS 600Nm kk810 (1180)	1495	1600	3831111049605	
013669	C Line 4 DZ VS 600Nm kk910 (1280)	1645	1767	3831111049698	
013606	C Line 4 DZ VS 600Nm kk1010 (1380)	1795	1933	3831111049063	
013615	C Line 4 DZ VS 600Nm kk1210 (1580)	2095	2267	3831111049155	
013624	C Line 4 DZ VS 600Nm kk1410 (1780)	2395	2600	3831111049247	

ŠIROKOKOTNA KARDANSKA GRED C Line 4 DZ VS 900Nm

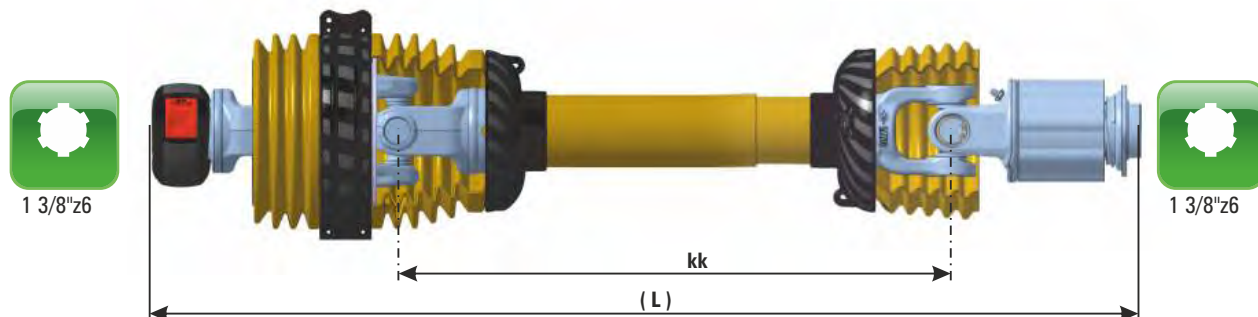

ARTIKEL	OZNAKA	DELOVNA DOLŽINA KARDANSKE GREDI		EAN 13 ČRTNA KODA
		priporočena L	maksimalna L	
013723	C Line 4 DZ VS 900Nm kk710 (1100)	1365	1453	3831111050236
013732	C Line 4 DZ VS 900Nm kk810 (1200)	1515	1620	3831111050328
013741	C Line 4 DZ VS 900Nm kk910 (1300)	1665	1787	3831111050410
013678	C Line 4 DZ VS 900Nm kk1010 (1400)	1815	1953	3831111049780
013687	C Line 4 DZ VS 900Nm kk1210 (1600)	2115	2287	3831111049872
013696	C Line 4 DZ VS 900Nm kk1410 (1800)	2415	2620	3831111049964

ŠIROKOKOTNA KARDANSKA GRED C Line 4 DZ ST 900Nm

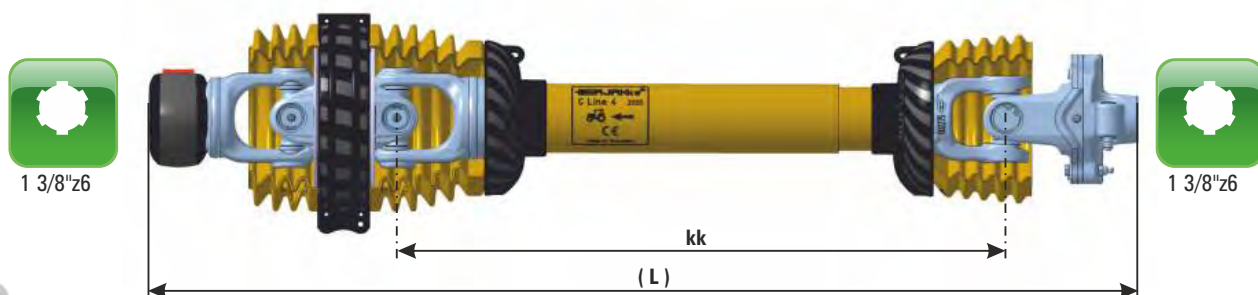

ARTIKEL	OZNAKA	DELOVNA DOLŽINA KARDANSKE GREDI		EAN 13 ČRTNA KODA	EAN 13 ČRTNA KODA
		priporočena L	maksimalna L		
024033	C Line 4 DZ ST 900Nm kk710 (1040)	1305	1393	3838433008471	
024036	C Line 4 DZ ST 900Nm kk810 (1140)	1455	1560	3838433008501	
021536	C Line 4 DZ ST 900Nm kk910 (1240)	1605	1727	3838433003995	
024037	C Line 4 DZ ST 900Nm kk1010 (1340)	1755	1893	3838433008518	
024038	C Line 4 DZ ST 900Nm kk1210 (1540)	2055	2227	3838433008525	
024039	C Line 4 DZ ST 900Nm kk1410 (1740)	2355	2560	3838433008532	

ŠIROKOKOTNA KARDANSKA GRED C Line 4 DZ ST 1300Nm

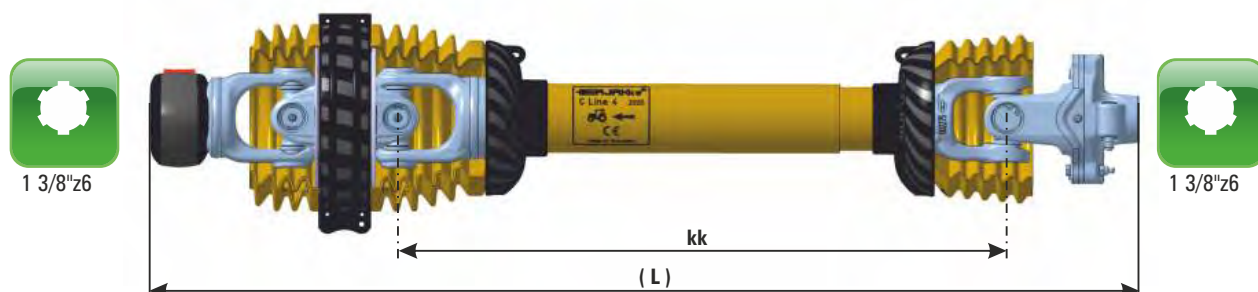

ARTIKEL	OZNAKA	DELOVNA DOLŽINA KARDANSKE GREDI		EAN 13 ČRTNA KODA	BARCODE
		priporočena L	maksimalna L		
029740	C Line 4 DZ ST 1300Nm kk710 (1060)	1325	1413	3838433028387	
029741	C Line 4 DZ ST 1300Nm kk810 (1160)	1475	1580	3838433028394	
029742	C Line 4 DZ ST 1300Nm kk910 (1260)	1625	1747	3838433028400	
024637	C Line 4 DZ ST 1300Nm kk1010 (1360)	1775	1913	3838433009324	
029743	C Line 4 DZ ST 1300Nm kk1210 (1560)	2075	2247	3838433028417	
025385	C Line 4 DZ ST 1300Nm kk1410 (1760)	2375	2580	3838433010740	

ŠIROKOKOTNA KARDANSKA GRED C Line 4 DZ ST 1700Nm

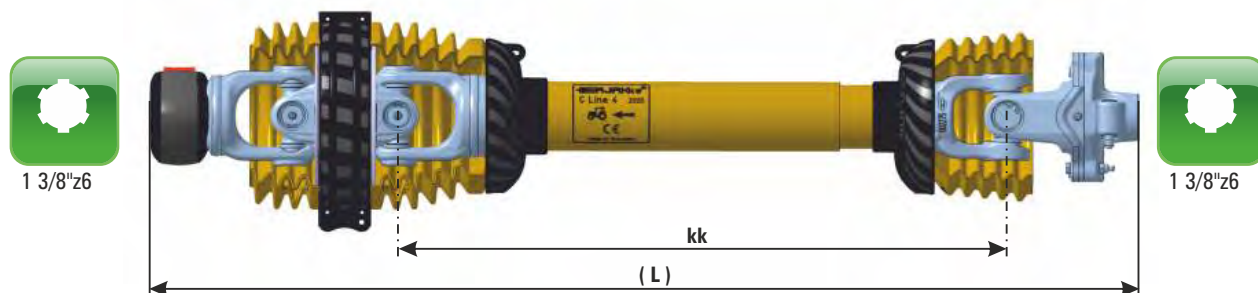

ARTIKEL	OZNAKA	DELOVNA DOLŽINA KARDANSKE GREDI		EAN 13 ČRTNA KODA	EAN 13 ČRTNA KODA
		priporočena L	maksimalna L		
024041	C Line 4 DZ ST 1700Nm kk710 (1060)	1325	1413	3838433008556	
024040	C Line 4 DZ ST 1700Nm kk810 (1160)	1475	1580	3838433008549	
021083	C Line 4 DZ ST 1700Nm kk910 (1260)	1625	1747	3838433003537	
020435	C Line 4 DZ ST 1700Nm kk1010 (1360)	1775	1913	3838433002257	
022904	C Line 4 DZ ST 1700Nm kk1210 (1560)	2075	2247	3838433007245	
022905	C Line 4 DZ ST 1700Nm kk1410 (1760)	2375	2580	3838433007252	

ŠIROKOKOTNA KARDANSKA GRED C Line 4 DZ TS 800Nm

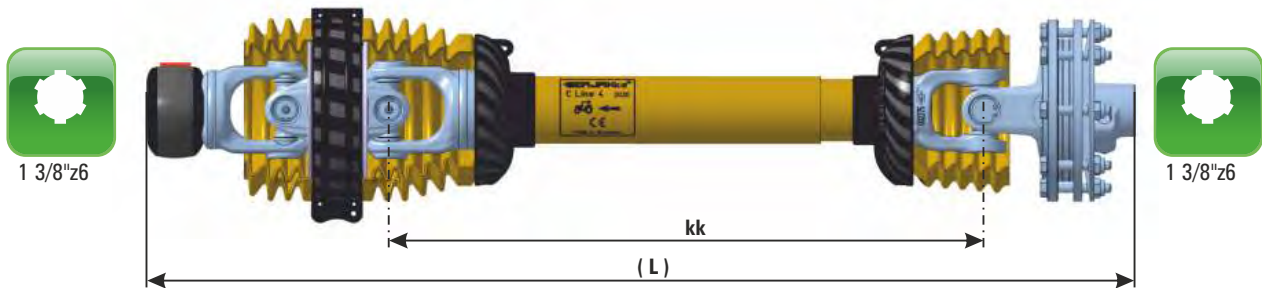

ARTIKEL	OZNAKA	DELOVNA DOLŽINA KARDANSKE GREDI		EAN 13 ČRTNA KODA
		priporočena L	maksimalna L	
013579	C Line 4 DZ TS 800Nm kk710 (1060)	1325	1413	3831111048790 
013588	C Line 4 DZ TS 800Nm kk810 (1160)	1475	1580	3831111048882 
013597	C Line 4 DZ TS 800Nm kk910 (1260)	1625	1747	3831111048974 
013534	C Line 4 DZ TS 800Nm kk1010 (1360)	1775	1913	3831111048349 
013543	C Line 4 DZ TS 800Nm kk1210 (1560)	2075	2247	3831111048431 
013552	C Line 4 DZ TS 800Nm kk1410 (1760)	2375	2580	3831111048523 



*Opcija



ŠIROKOKOTNA KARDANSKA GRED C Line 6 DZ BR+

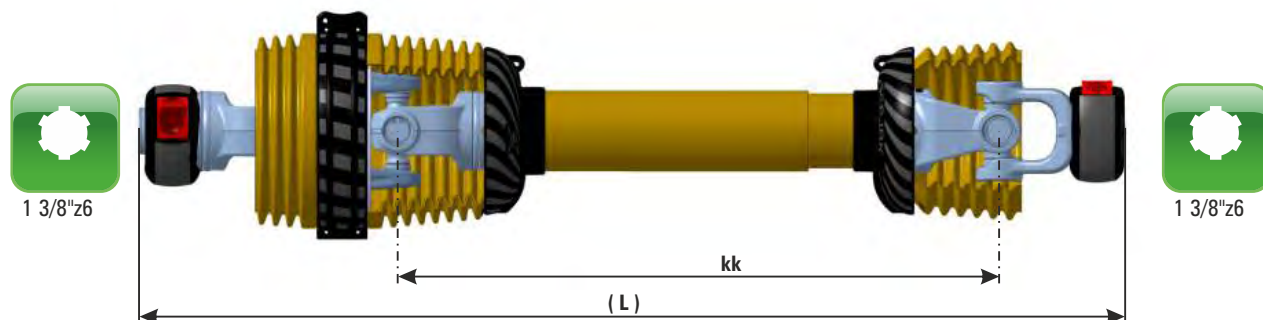

ARTIKEL	OZNAKA	DELOVNA DOLŽINA KARDANSKE GREDI		EAN 13 ČRTNA KODA	
		priporočena L	maksimalna L		
014075	C Line 6 DZ BR+ kk710 (1100)	1348	1430	3831111053756	
014100	C Line 6 DZ BR+ kk810 (1200)	1498	1597	3831111054005	
014125	C Line 6 DZ BR+ kk910 (1300)	1648	1763	3831111054258	
013950	C Line 6 DZ BR+ kk1010 (1400)	1798	1930	3831111052506	
013975	C Line 6 DZ BR+ kk1210 (1600)	2098	2263	3831111052759	
014000	C Line 6 DZ BR+ kk1410 (1800)	2398	2597	3831111053008	

ŠIROKOKOTNA KARDANSKA GRED C Line 6 DZ DZ BR+

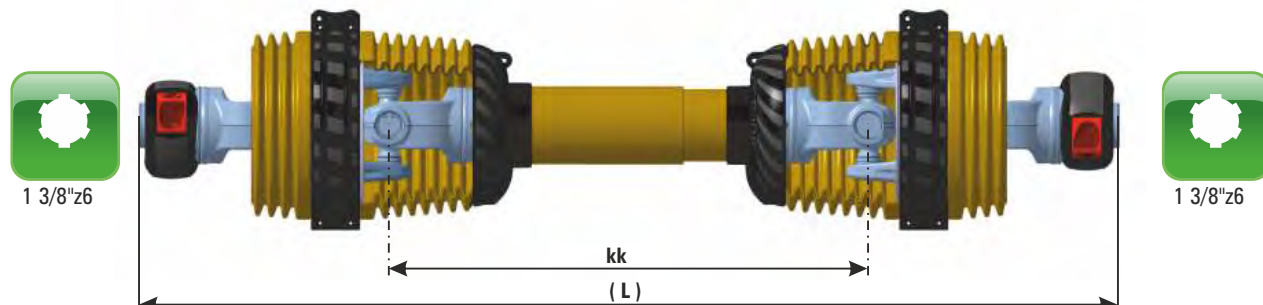

ARTIKEL	OZNAKA	DELOVNA DOLŽINA KARDANSKE GREDI		EAN 13 ČRTNA KODA	EAN 13 ČRTNA KODA
		priporočena L	maksimalna L		
014875	C Line 6 DZ DZ BR+ kk710 (1230)	1478	1560	3831111061751	
014900	C Line 6 DZ DZ BR+ kk810 (1330)	1628	1727	3831111062000	
014925	C Line 6 DZ DZ BR+ kk910 (1430)	1778	1893	3831111062253	
014150	C Line 6 DZ DZ BR+ kk1010 (1530)	1928	2060	3831111054500	
014775	C Line 6 DZ DZ BR+ kk1210 (1730)	2228	2393	3831111060754	
014200	C Line 6 DZ DZ BR+ kk1410 (1930)	2528	2727	3831111055002	

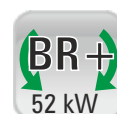

ŠIROKOKOTNA KARDANSKA GRED C Line 6 DZ PS

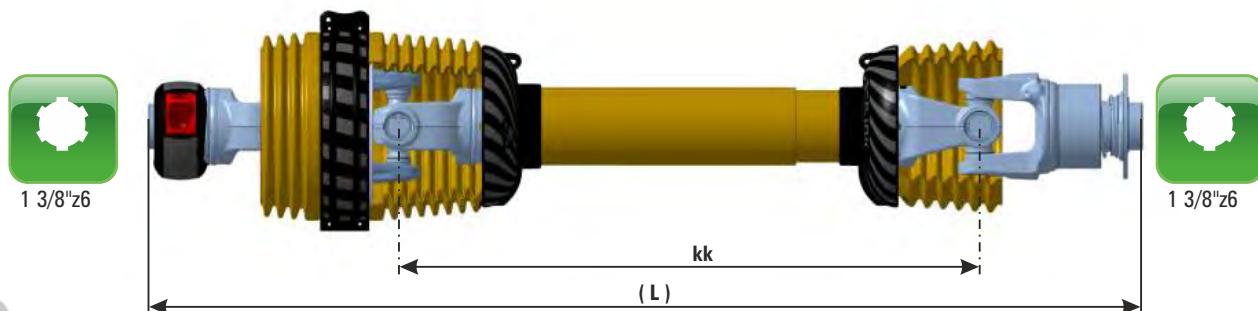

PS
52 kW

6

80°

max.
1000
RPM

ARTIKEL	OZNAKA	DELOVNA DOLŽINA KARDANSKE GREDI		EAN 13 ČRTNA KODA
		priporočena L	maksimalna L	
015475	C Line 6 DZ PS kk710 (1140)	1388	1470	3831111067753
015500	C Line 6 DZ PS kk810 (1240)	1538	1637	3831111068002
015525	C Line 6 DZ PS kk910 (1340)	1688	1803	3831111068255
015350	C Line 6 DZ PS kk1010 (1440)	1838	1970	3831111066503
015375	C Line 6 DZ PS kk1210 (1640)	2138	2303	3831111066756
015400	C Line 6 DZ PS kk1410 (1840)	2438	2637	3831111067005

*Opcija

PS + TS

ŠIROKOKOTNA KARDANSKA GRED C Line 6 DZ VS1 1200Nm

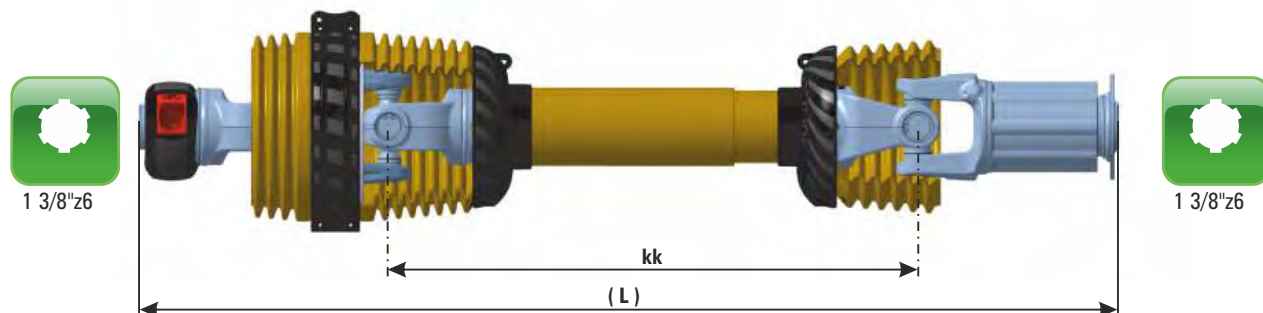

ARTIKEL	OZNAKA	DELOVNA DOLŽINA KARDANSKE GREDI		EAN 13 ČRTNA KODA
		priporočena L	maksimalna L	
015875	C Line 6 DZ VS1 1200Nm kk710 (1180)	1428	1510	3831111071750 
015900	C Line 6 DZ VS1 1200Nm kk810 (1280)	1578	1677	3831111072009 
015925	C Line 6 DZ VS1 1200Nm kk910 (1380)	1728	1843	3831111072252 
015750	C Line 6 DZ VS1 1200Nm kk1010 (1480)	1878	2010	3831111070500 
015775	C Line 6 DZ VS1 1200Nm kk1210 (1680)	2178	2343	3831111070753 
015800	C Line 6 DZ VS1 1200Nm kk1410 (1880)	2478	2677	3831111071002 

ŠIROKOKOTNA KARDANSKA GRED C Line 6 DZ VS1 1500Nm

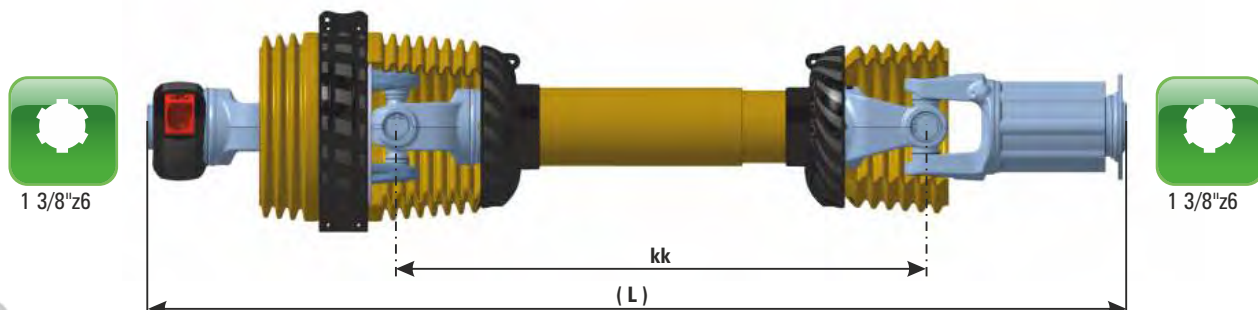

ARTIKEL	OZNAKA	DELOVNA DOLŽINA KARDANSKE GREDI		EAN 13 ČRTNA KODA	BARČNA KODA
		priporočena L	maksimalna L		
016075	C Line 6 DZ VS1 1500Nm kk710 (1200)	1448	1530	3831111073754	
016100	C Line 6 DZ VS1 1500Nm kk810 (1300)	1598	1697	3831111074003	
016125	C Line 6 DZ VS1 1500Nm kk910 (1400)	1748	1863	3831111074256	
015950	C Line 6 DZ VS1 1500Nm kk1010 (1500)	1898	2030	3831111072504	
015975	C Line 6 DZ VS1 1500Nm kk1210 (1700)	2198	2363	3831111072757	
016000	C Line 6 DZ VS1 1500Nm kk1410 (1900)	2498	2697	3831111073006	

ŠIROKOKOTNA KARDANSKA GRED C Line 6 DZ ST 1700Nm

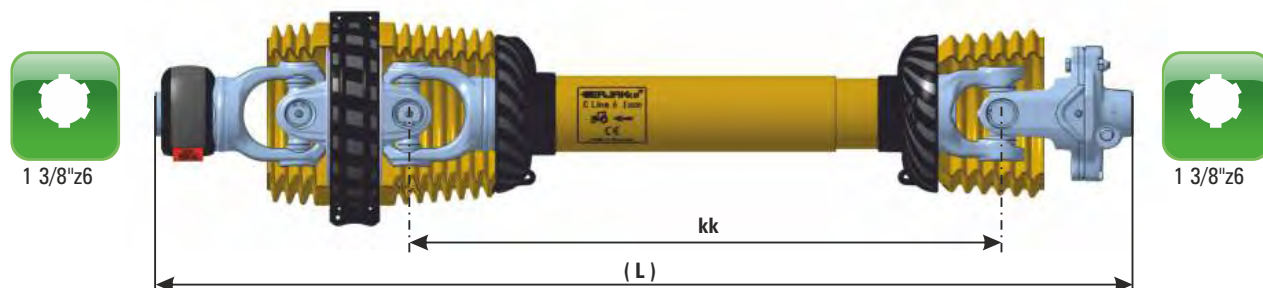

ARTIKEL	OZNAKA	DELOVNA DOLŽINA KARDANSKE GREDI		EAN 13 ČRTNA KODA	BARCODE
		priporočena L	maksimalna L		
029876	C Line 6 DZ ST 1700Nm kk710 (1110)	1358	1440	3838433029742	
029877	C Line 6 DZ ST 1700Nm kk810 (1210)	1508	1607	3838433029759	
028071	C Line 6 DZ ST 1700Nm kk910 (1310)	1658	1773	3838433012850	
029878	C Line 6 DZ ST 1700Nm kk1010 (1410)	1808	1940	3838433029766	
025632	C Line 6 DZ ST 1700Nm kk1210 (1610)	2108	2273	3838433011082	
029879	C Line 6 DZ ST 1700Nm kk1410 (1810)	2408	2607	3838433029773	

ŠIROKOKOTNA KARDANSKA GRED C Line 6 DZ ST 2000Nm

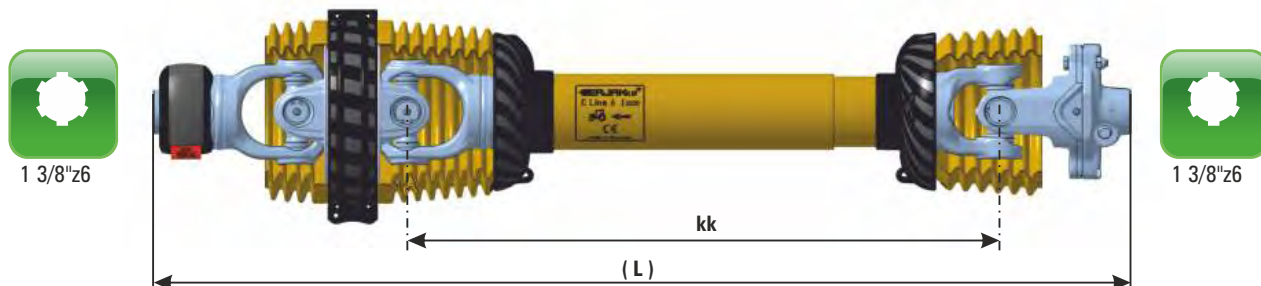

1 3/8"z6

1 3/8"z6

kk

(L)



ARTIKEL	OZNAKA	DELOVNA DOLŽINA KARDANSKE GREDI		EAN 13 ČRTNA KODA
		priporočena L	maksimalna L	
030074	C Line 6 DZ ST 2000Nm kk710 (1110)	1358	1440	3838433031721
030075	C Line 6 DZ ST 2000Nm kk810 (1210)	1508	1607	3838433031738
030076	C Line 6 DZ ST 2000Nm kk910 (1310)	1658	1773	3838433031745
026149	C Line 6 DZ ST 2000Nm kk1010 (1410)	1808	1940	3838433011891
030077	C Line 6 DZ ST 2000Nm kk1210 (1610)	2108	2273	3838433031752
030078	C Line 6 DZ ST 2000Nm kk1410 (1810)	2408	2607	3838433031769

ŠIROKOKOTNA KARDANSKA GRED C Line 6 DZ ST 2400Nm

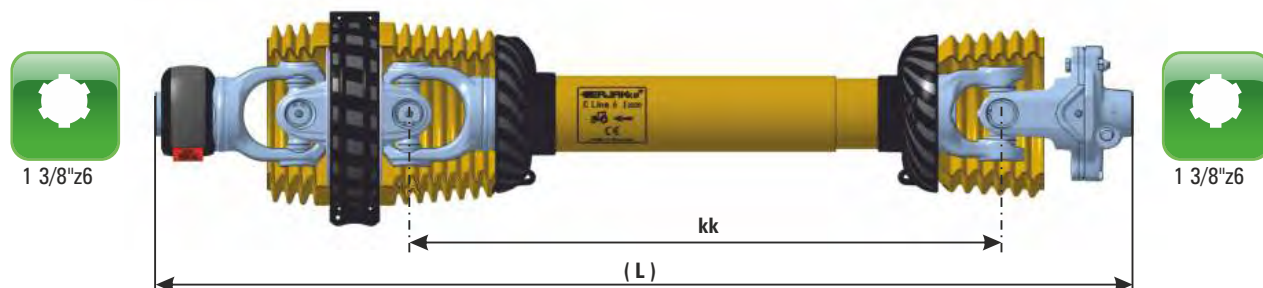

ARTIKEL	OZNAKA	DELOVNA DOLŽINA KARDANSKE GREDI		EAN 13 ČRTNA KODA	BARČNA KODA
		priporočena L	maksimalna L		
030273	C Line 6 DZ ST 2400Nm kk710 (1110)	1358	1440	3838433033718	
030274	C Line 6 DZ ST 2400Nm kk810 (1210)	1508	1607	3838433033725	
030275	C Line 6 DZ ST 2400Nm kk910 (1310)	1658	1773	3838433033732	
030276	C Line 6 DZ ST 2400Nm kk1010 (1410)	1808	1940	3838433033749	
030277	C Line 6 DZ ST 2400Nm kk1210 (1610)	2108	2273	3838433033756	
030278	C Line 6 DZ ST 2400Nm kk1410 (1810)	2408	2607	3838433033763	

ŠIROKOKOTNA KARDANSKA GRED C Line 6 DZ ST 2700Nm

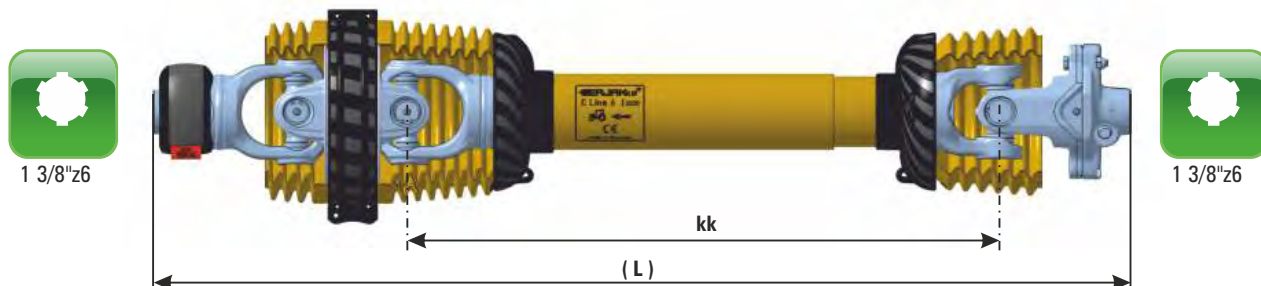

1 3/8"z6

1 3/8"z6

kk

(L)



ARTIKEL	OZNAKA	DELOVNA DOLŽINA KARDANSKE GREDI		EAN 13 ČRTNA KODA	BARCODE
		priporočena L	maksimalna L		
024030	C Line 6 DZ ST 2700Nm kk710 (1110)	1358	1440	3838433008464	
024029	C Line 6 DZ ST 2700Nm kk810 (1210)	1508	1607	3838433008457	
024028	C Line 6 DZ ST 2700Nm kk910 (1310)	1658	1773	3838433008440	
020436	C Line 6 DZ ST 2700Nm kk1010 (1410)	1808	1940	3838433002264	
022418	C Line 6 DZ ST 2700Nm kk1210 (1610)	2108	2273	3838433006323	
020887	C Line 6 DZ ST 2700Nm kk1410 (1810)	2408	2607	3838433003346	

ŠIROKOKOTNA KARDANSKA GRED C Line 6 DZ TS 1200Nm

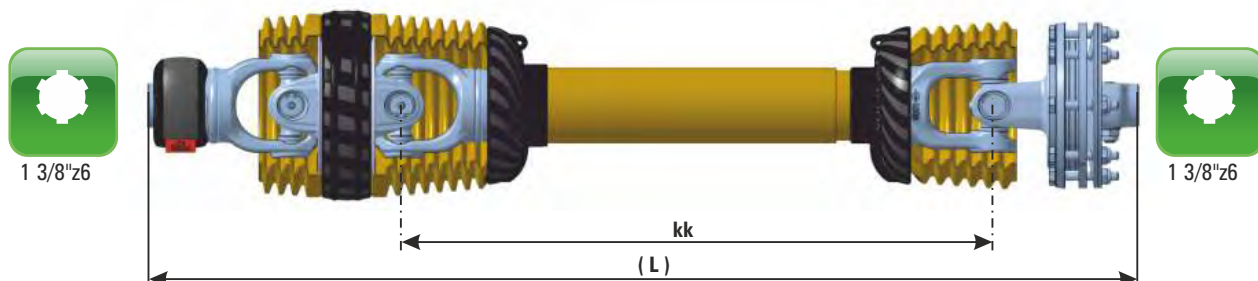

ARTIKEL	OZNAKA	DELOVNA DOLŽINA KARDANSKE GREDI		EAN 13 ČRTNA KODA
		priporočena L	maksimalna L	
015675	C Line 6 DZ TS 1200Nm kk710 (1130)	1378	1460	3831111069757
015700	C Line 6 DZ TS 1200Nm kk810 (1230)	1528	1627	3831111070005
015725	C Line 6 DZ TS 1200Nm kk910 (1330)	1678	1793	3831111070258
015550	C Line 6 DZ TS 1200Nm kk1010 (1430)	1828	1960	3831111068507
015575	C Line 6 DZ TS 1200Nm kk1210 (1630)	2128	2293	3831111068750
015600	C Line 6 DZ TS 1200Nm kk1410 (1830)	2428	2627	3831111069009

*Opcija



ŠIROKOKOTNA KARDANSKA GRED C Line 8 DZ BR+

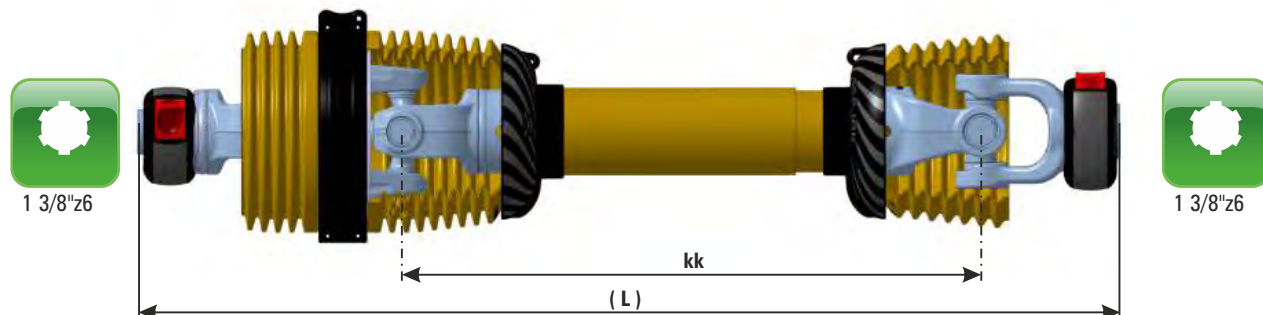

ARTIKEL	OZNAKA	DELOVNA DOLŽINA KARDANSKE GREDI		EAN 13 ČRTNA KODA	EAN 13 ČRTNA KODA
		priporočena L	maksimalna L		
016475	C Line 8 DZ BR+ kk710 (1140)	1365	1440	3831111077752	
016500	C Line 8 DZ BR+ kk810 (1240)	1515	1607	3831111078001	
016525	C Line 8 DZ BR+ kk910 (1340)	1665	1773	3831111078254	
016350	C Line 8 DZ BR+ kk1010 (1440)	1815	1940	3831111076502	
016375	C Line 8 DZ BR+ kk1210 (1640)	2115	2273	3831111076755	
016400	C Line 8 DZ BR+ kk1410 (1840)	2415	2607	3831111077004	

ŠIROKOKOTNA KARDANSKA GRED C Line 8 DZ DZ BR+

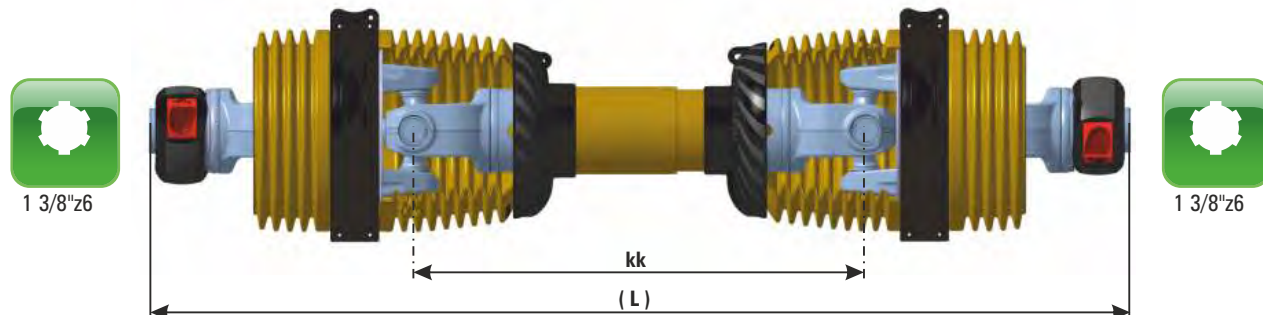

ARTIKEL	OZNAKA	DELOVNA DOLŽINA KARDANSKE GREDI		EAN 13 ČRTNA KODA	Barcode
		priporočena L	maksimalna L		
017275	C Line 8 DZ DZ BR+ kk710 (1270)	1495	1570	3831111085757	
017300	C Line 8 DZ DZ BR+ kk810 (1370)	1645	1737	3831111086006	
017325	C Line 8 DZ DZ BR+ kk910 (1470)	1795	1903	3831111086259	
016550	C Line 8 DZ DZ BR+ kk1010 (1570)	1945	2070	3831111078506	
016575	C Line 8 DZ DZ BR+ kk1210 (1770)	2245	2403	3831111078759	
017200	C Line 8 DZ DZ BR+ kk1410 (1970)	2545	2737	3831111085009	

ŠIROKOKOTNA KARDANSKA GRED C Line 8 DZ PS

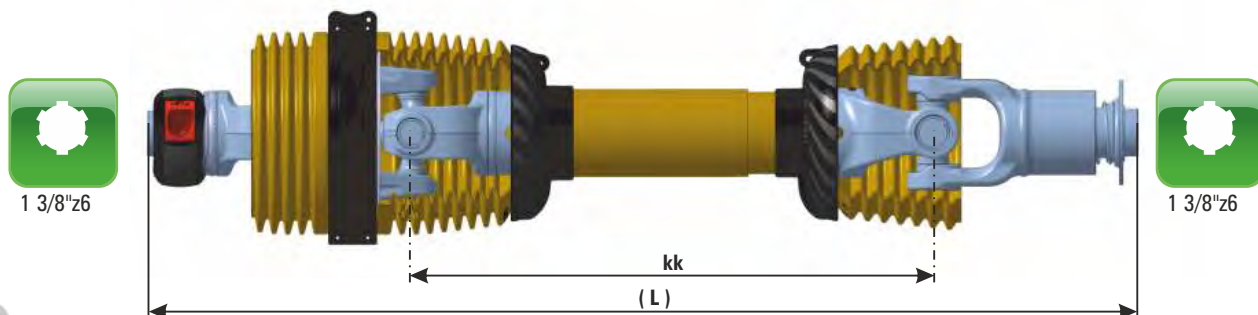

PS
85 kW

8

80°

max.
1000 RPM

ARTIKEL	OZNAKA	DELOVNA DOLŽINA KARDANSKE GREDI		EAN 13 ČRTNA KODA	EAN 13 ČRTNA KODA
		priporočena L	maksimalna L		
017675	C Line 8 DZ PS kk710 (1210)	1435	1510	3831111089755	
017700	C Line 8 DZ PS kk810 (1310)	1585	1677	3831111090003	
017725	C Line 8 DZ PS kk910 (1410)	1735	1843	3831111090256	
017550	C Line 8 DZ PS kk1010 (1510)	1885	2010	3831111088505	
017575	C Line 8 DZ PS kk1210 (1710)	2185	2343	3831111088758	
017600	C Line 8 DZ PS kk1410 (1910)	2485	2677	3831111089007	

*Opcija

PS + TS

ŠIROKOKOTNA KARDANSKA GRED C Line 8 DZ VS1 1500Nm

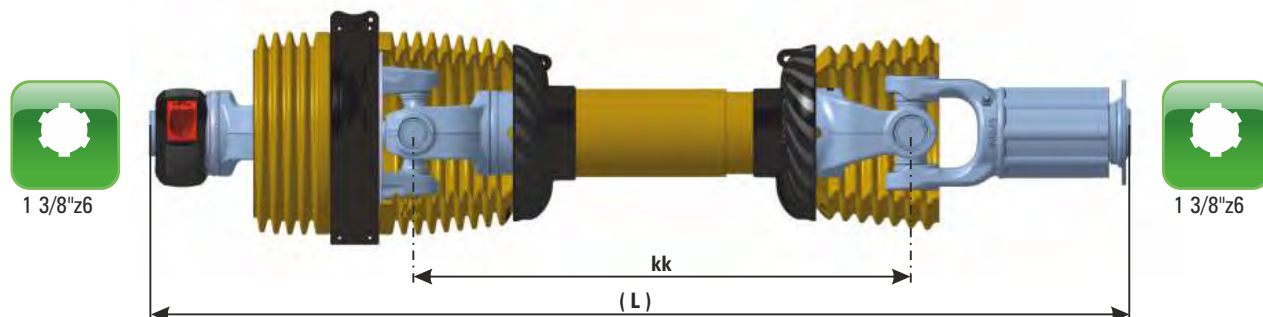

ARTIKEL	OZNAKA	DELOVNA DOLŽINA KARDANSKE GREDI		EAN 13 ČRTNA KODA
		priporočena L	maksimalna L	
024022	C Line 8 DZ VS1 1500Nm kk710 (1240)	1465	1540	3838433008389
024023	C Line 8 DZ VS1 1500Nm kk810 (1340)	1615	1707	3838433008396
024024	C Line 8 DZ VS1 1500Nm kk910 (1440)	1765	1873	3838433008402
024025	C Line 8 DZ VS1 1500Nm kk1010 (1540)	1915	2040	3838433008419
024026	C Line 8 DZ VS1 1500Nm kk1210 (1740)	2215	2373	3838433008426
024027	C Line 8 DZ VS1 1500Nm kk1410 (1940)	2515	2707	3838433008433

ŠIROKOKOTNA KARDANSKA GRED C Line 8 DZ ST 2400Nm

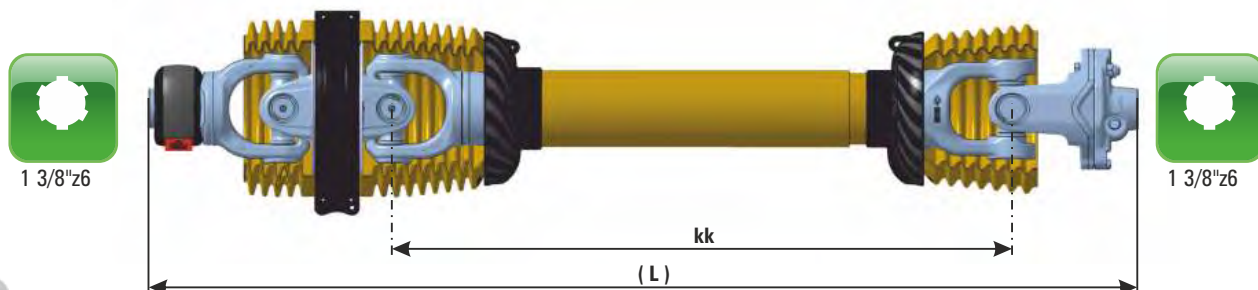

ARTIKEL	OZNAKA	DELOVNA DOLŽINA KARDANSKE GREDI		EAN 13 ČRTNA KODA	EAN 13 ČRTNA KODA
		priporočena L	maksimalna L		
030663	C Line 8 DZ ST 2400Nm kk710 (1140)	1365	1440	3838433037617	
030664	C Line 8 DZ ST 2400Nm kk810 (1240)	1515	1607	3838433037624	
030665	C Line 8 DZ ST 2400Nm kk910 (1340)	1665	1773	3838433037631	
030666	C Line 8 DZ ST 2400Nm kk1010 (1440)	1815	1940	3838433037648	
030667	C Line 8 DZ ST 2400Nm kk1210 (1640)	2115	2273	3838433037655	
030668	C Line 8 DZ ST 2400Nm kk1410 (1840)	2415	2607	3838433037662	

ŠIROKOKOTNA KARDANSKA GRED C Line 8 DZ ST 2700Nm

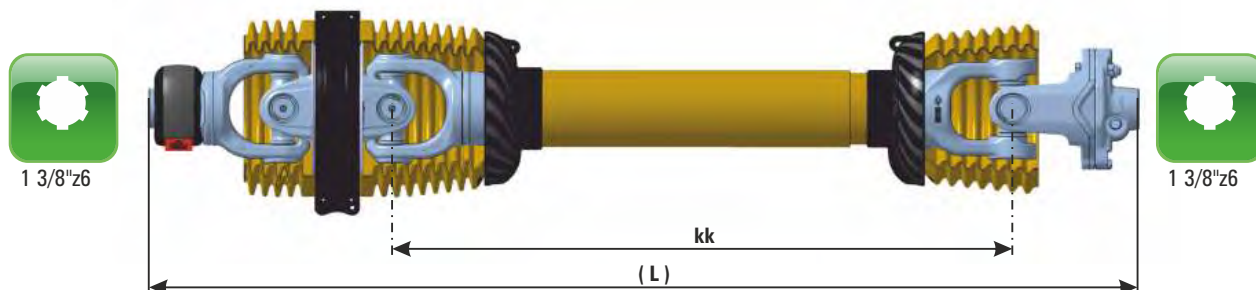

ARTIKEL	OZNAKA	DELOVNA DOLŽINA KARDANSKE GREDI		EAN 13 ČRTNA KODA	BARCODE
		priporočena L	maksimalna L		
030863	C Line 8 DZ ST 2700Nm kk710 (1140)	1365	1440	3838433039611	
030864	C Line 8 DZ ST 2700Nm kk810 (1240)	1515	1607	3838433039628	
028122	C Line 8 DZ ST 2700Nm kk910 (1340)	1665	1773	3838433012867	
030865	C Line 8 DZ ST 2700Nm kk1010 (1440)	1815	1940	3838433039635	
030866	C Line 8 DZ ST 2700Nm kk1210 (1640)	2115	2273	3838433039642	
030867	C Line 8 DZ ST 2700Nm kk1410 (1840)	2415	2607	3838433039659	

ŠIROKOKOTNA KARDANSKA GRED C Line 8 DZ ST 3000Nm

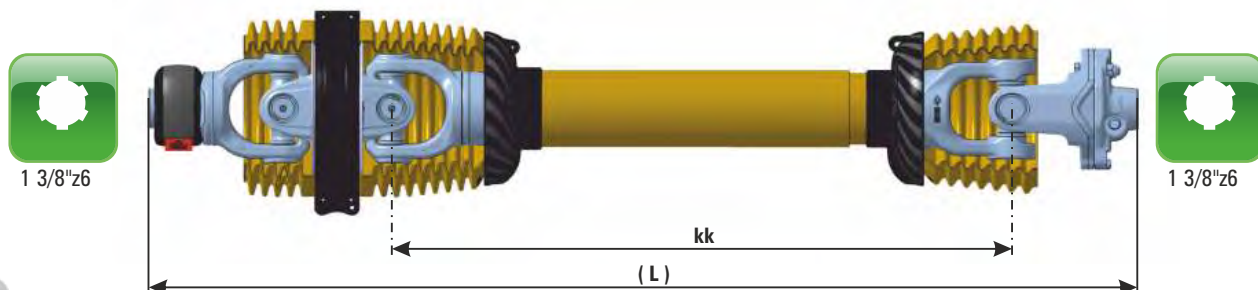

ARTIKEL	OZNAKA	DELOVNA DOLŽINA KARDANSKE GREDI		EAN 13 ČRTNA KODA	EAN 13 ČRTNA KODA
		priporočena L	maksimalna L		
024015	C Line 8 DZ ST 3000Nm kk710 (1140)	1365	1440	3838433008310	
024013	C Line 8 DZ ST 3000Nm kk810 (1240)	1515	1607	3838433008303	
024012	C Line 8 DZ ST 3000Nm kk910 (1340)	1665	1773	3838433008297	
022913	C Line 8 DZ ST 3000Nm kk1010 (1440)	1815	1940	3838433007313	
022914	C Line 8 DZ ST 3000Nm kk1210 (1640)	2115	2273	3838433007320	
022915	C Line 8 DZ ST 3000Nm kk1410 (1840)	2415	2607	3838433007337	

ŠIROKOKOTNA KARDANSKA GRED C Line 8 DZ ST 3500Nm

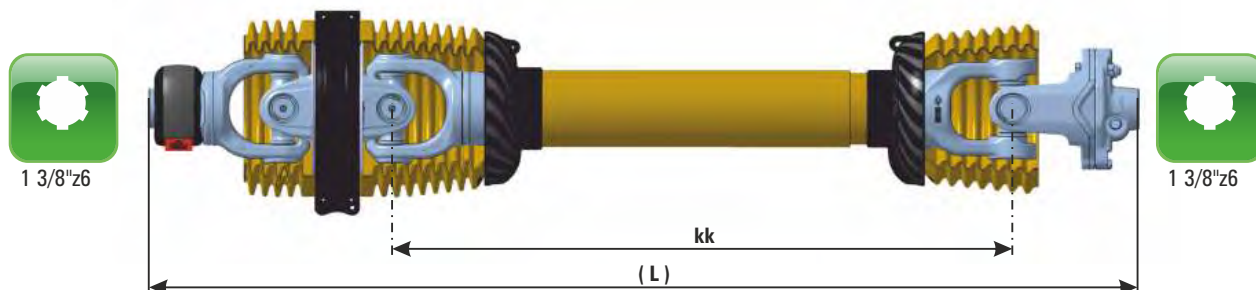

ARTIKEL	OZNAKA	DELOVNA DOLŽINA KARDANSKE GREDI		EAN 13 ČRTNA KODA
		priporočena L	maksimalna L	
024016	C Line 8 DZ ST 3500Nm kk710 (1140)	1365	1440	3838433008327
024017	C Line 8 DZ ST 3500Nm kk810 (1240)	1515	1607	3838433008334
024018	C Line 8 DZ ST 3500Nm kk910 (1340)	1665	1773	3838433008341
024019	C Line 8 DZ ST 3500Nm kk1010 (1440)	1815	1940	3838433008358
024020	C Line 8 DZ ST 3500Nm kk1210 (1640)	2115	2273	3838433008365
024021	C Line 8 DZ ST 3500Nm kk1410 (1840)	2415	2607	3838433008372



ŠIROKOKOTNA KARDANSKA GRED C Line 8 DZ TS 1800Nm

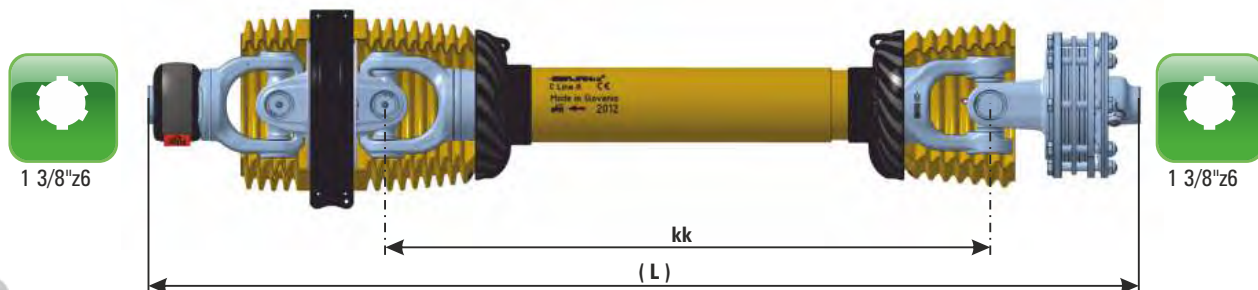

ARTIKEL	OZNAKA	DELOVNA DOLŽINA KARDANSKE GREDI		EAN 13 ČRTNA KODA	EAN 13 ČRTNA KODA
		priporočena L	maksimalna L		
017875	C Line 8 DZ TS 1800Nm kk710 (1170)	1395	1470	3831111091758	
017900	C Line 8 DZ TS 1800Nm kk810 (1270)	1545	1637	3831111092007	
017925	C Line 8 DZ TS 1800Nm kk910 (1370)	1695	1803	3831111092250	
017750	C Line 8 DZ TS 1800Nm kk1010 (1470)	1845	1970	3831111090508	
017775	C Line 8 DZ TS 1800Nm kk1210 (1670)	2145	2303	3831111090751	
017800	C Line 8 DZ TS 1800Nm kk1410 (1870)	2445	2637	3831111091000	

*Opcija



ŠIROKOKOTNA KARDANSKA GRED C Line 8 DZ TS 2600Nm

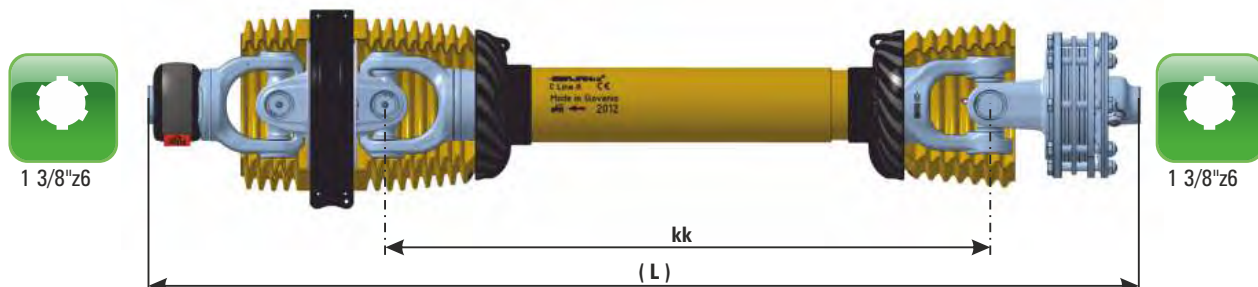

ARTIKEL	OZNAKA	DELOVNA DOLŽINA KARDANSKE GREDI		EAN 13 ČRTNA KODA	
		priporočena L	maksimalna L		
018075	C Line 8 DZ TS 2600Nm kk710 (1170)	1395	1470	3831111093752	
018100	C Line 8 DZ TS 2600Nm kk810 (1270)	1545	1637	3831111094001	
018125	C Line 8 DZ TS 2600Nm kk910 (1370)	1695	1803	3831111094254	
017950	C Line 8 DZ TS 2600Nm kk1010 (1470)	1845	1970	3831111092502	
017975	C Line 8 DZ TS 2600Nm kk1210 (1670)	2145	2303	3831111092755	
018000	C Line 8 DZ TS 2600Nm kk1410 (1870)	2445	2637	3831111093004	

*Opcija



ŠIROKOKOTNA KARDANSKA GRED C Line 4 DZ BR+

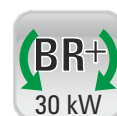
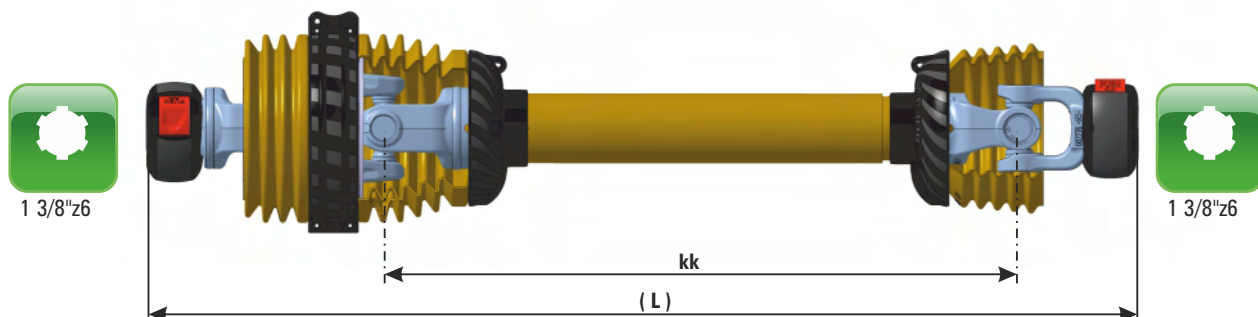

ARTIKEL	OZNAKA	DELOVNA DOLŽINA KARDANSKE GREDI		EAN 13 ČRTNA KODA
		priporočena L	maksimalna L	
013007	C Line 4 DZ BR+ kk710 (1040)	1305	1393	3831111043078
013016	C Line 4 DZ BR+ kk810 (1140)	1455	1560	3831111043160
013025	C Line 4 DZ BR+ kk910 (1240)	1605	1727	3831111043252
012962	C Line 4 DZ BR+ kk1010 (1340)	1755	1893	3831111042620
012971	C Line 4 DZ BR+ kk1210 (1540)	2055	2227	3831111042712
012980	C Line 4 DZ BR+ kk1410 (1740)	2355	2560	3831111042804

ŠIROKOKOTNA KARDANSKA GRED C Line 4 DZ DZ BR+

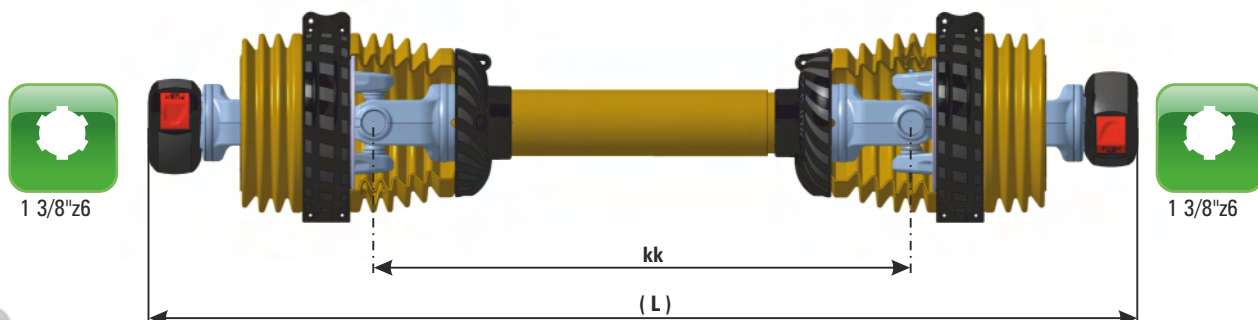

ARTIKEL	OZNAKA	DELOVNA DOLŽINA KARDANSKE GREDI		EAN 13 ČRTNA KODA	
		priporočena L	maksimalna L		
013220	C Line 4 DZ DZ BR+ kk710 (1150)	1415	1503	3831111045201	
013088	C Line 4 DZ DZ BR+ kk810 (1250)	1565	1670	3831111043887	
013097	C Line 4 DZ DZ BR+ kk910 (1350)	1715	1837	3831111043979	
013034	C Line 4 DZ DZ BR+ kk1010 (1450)	1865	2003	3831111043344	
013043	C Line 4 DZ DZ BR+ kk1210 (1650)	2165	2337	3831111043436	
013052	C Line 4 DZ DZ BR+ kk1410 (1850)	2465	2670	3831111043528	

ŠIROKOKOTNA KARDANSKA GRED C Line 4 DZ PS

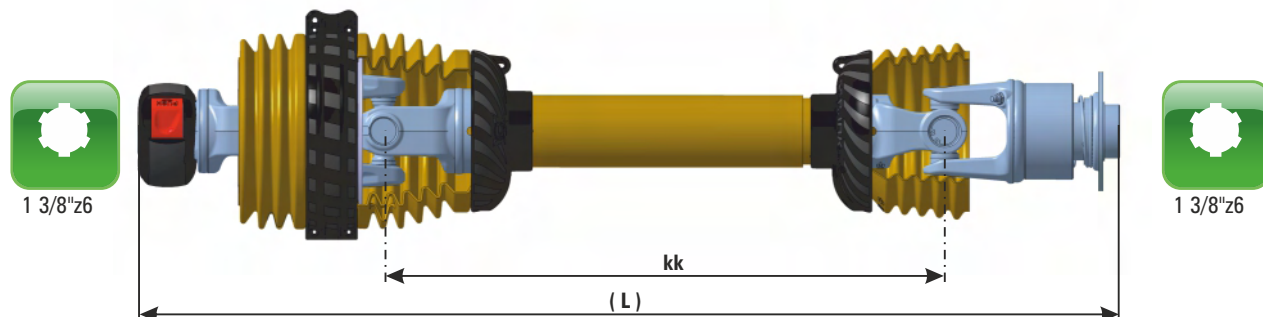

ARTIKEL	OZNAKA	DELOVNA DOLŽINA KARDANSKE GREDI		EAN 13 ČRTNA KODA
		priporočena L	maksimalna L	
013507	C Line 4 DZ PS kk710 (1090)	1355	1443	3831111048073
013516	C Line 4 DZ PS kk810 (1190)	1505	1610	3831111048165
013525	C Line 4 DZ PS kk910 (1290)	1655	1777	3831111048257
013462	C Line 4 DZ PS kk1010 (1390)	1805	1943	3831111047625
013471	C Line 4 DZ PS kk1210 (1590)	2105	2277	3831111047717
013480	C Line 4 DZ PS kk1410 (1790)	2405	2610	3831111047809



*Opcija



ŠIROKOKOTNA KARDANSKA GRED C Line 4 DZ VS 600Nm

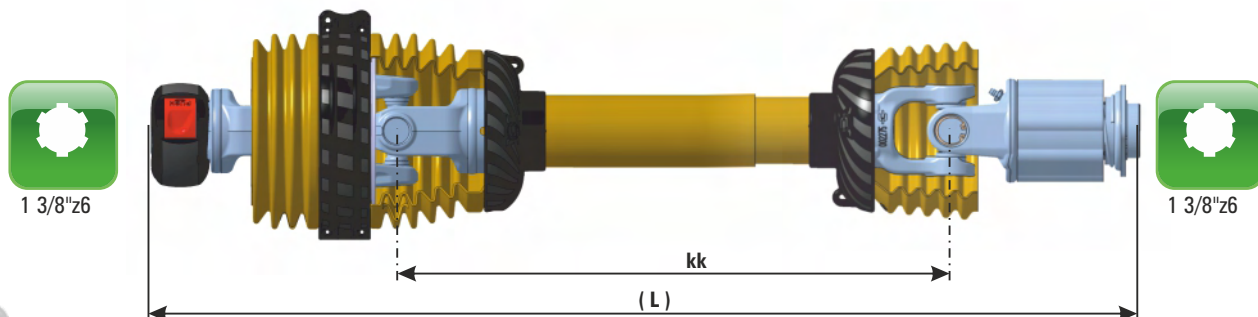

ARTIKEL	OZNAKA	DELOVNA DOLŽINA KARDANSKE GREDI		EAN 13 ČRTNA KODA	EAN 13 ČRTNA KODA
		priporočena L	maksimalna L		
013651	C Line 4 DZ VS 600Nm kk710 (1080)	1345	1433	3831111049513	
013660	C Line 4 DZ VS 600Nm kk810 (1180)	1495	1600	3831111049605	
013669	C Line 4 DZ VS 600Nm kk910 (1280)	1645	1767	3831111049698	
013606	C Line 4 DZ VS 600Nm kk1010 (1380)	1795	1933	3831111049063	
013615	C Line 4 DZ VS 600Nm kk1210 (1580)	2095	2267	3831111049155	
013624	C Line 4 DZ VS 600Nm kk1410 (1780)	2395	2600	3831111049247	

ŠIROKOKOTNA KARDANSKA GRED C Line 4 DZ VS 900Nm

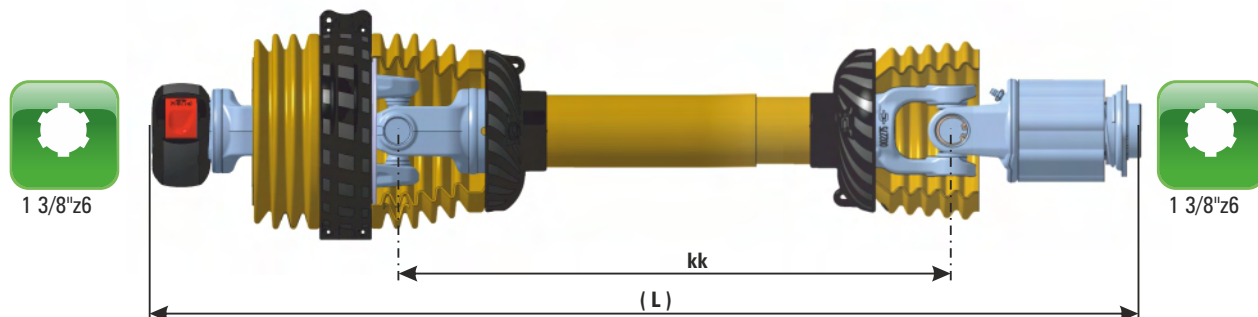

ARTIKEL	OZNAKA	DELOVNA DOLŽINA KARDANSKE GREDI		EAN 13 ČRTNA KODA	BARCODE
		priporočena L	maksimalna L		
013723	C Line 4 DZ VS 900Nm kk710 (1100)	1365	1453	3831111050236	
013732	C Line 4 DZ VS 900Nm kk810 (1200)	1515	1620	3831111050328	
013741	C Line 4 DZ VS 900Nm kk910 (1300)	1665	1787	3831111050410	
013678	C Line 4 DZ VS 900Nm kk1010 (1400)	1815	1953	3831111049780	
013687	C Line 4 DZ VS 900Nm kk1210 (1600)	2115	2287	3831111049872	
013696	C Line 4 DZ VS 900Nm kk1410 (1800)	2415	2620	3831111049964	

ŠIROKOKOTNA KARDANSKA GRED C Line 4 DZ ST 900Nm

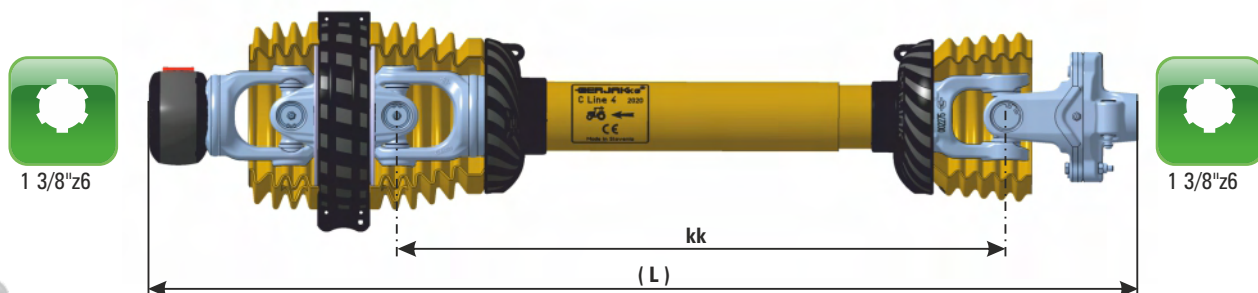

ARTIKEL	OZNAKA	DELOVNA DOLŽINA KARDANSKE GREDI		EAN 13 ČRTNA KODA	EAN 13 ČRTNA KODA
		priporočena L	maksimalna L		
024033	C Line 4 DZ ST 900Nm kk710 (1040)	1305	1393	3838433008471	
024036	C Line 4 DZ ST 900Nm kk810 (1140)	1455	1560	3838433008501	
021536	C Line 4 DZ ST 900Nm kk910 (1240)	1605	1727	3838433003995	
024037	C Line 4 DZ ST 900Nm kk1010 (1340)	1755	1893	3838433008518	
024038	C Line 4 DZ ST 900Nm kk1210 (1540)	2055	2227	3838433008525	
024039	C Line 4 DZ ST 900Nm kk1410 (1740)	2355	2560	3838433008532	

ŠIROKOKOTNA KARDANSKA GRED C Line 4 DZ ST 1300Nm

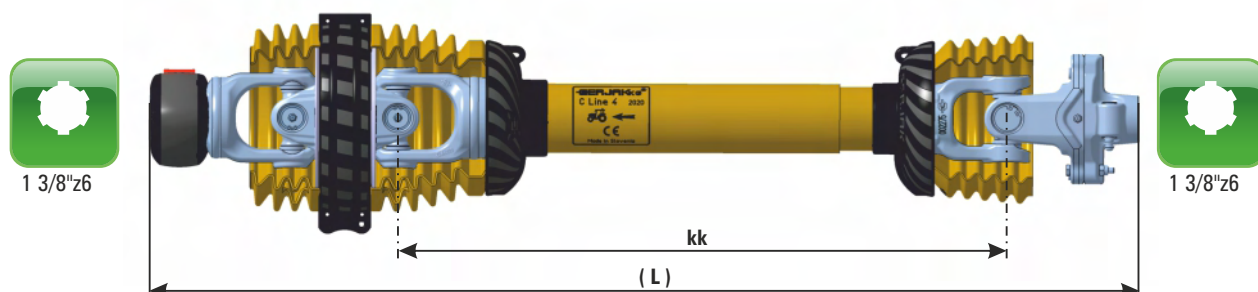

ARTIKEL	OZNAKA	DELOVNA DOLŽINA KARDANSKE GREDI		EAN 13 ČRTNA KODA	BARCODE
		priporočena L	maksimalna L		
029740	C Line 4 DZ ST 1300Nm kk710 (1060)	1325	1413	3838433028387	
029741	C Line 4 DZ ST 1300Nm kk810 (1160)	1475	1580	3838433028394	
029742	C Line 4 DZ ST 1300Nm kk910 (1260)	1625	1747	3838433028400	
024637	C Line 4 DZ ST 1300Nm kk1010 (1360)	1775	1913	3838433009324	
029743	C Line 4 DZ ST 1300Nm kk1210 (1560)	2075	2247	3838433028417	
025385	C Line 4 DZ ST 1300Nm kk1410 (1760)	2375	2580	3838433010740	

ŠIROKOKOTNA KARDANSKA GRED C Line 4 DZ ST 1700Nm

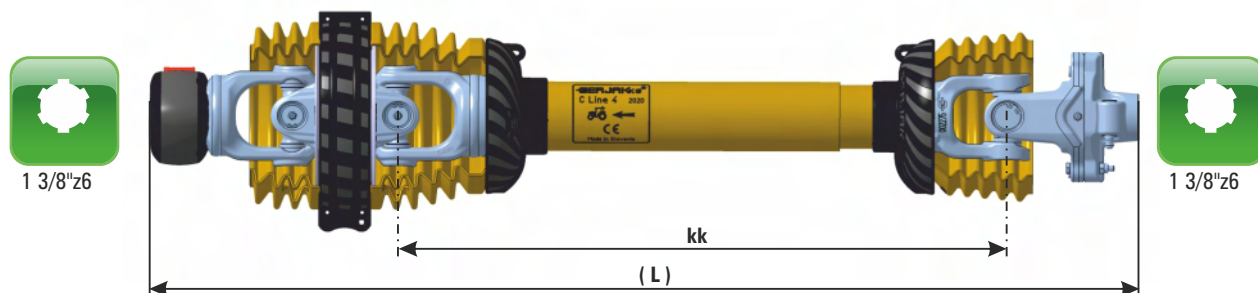

1 3/8"z6

1 3/8"z6

kk

(L)



ARTIKEL	OZNAKA	DELOVNA DOLŽINA KARDANSKE GREDI		EAN 13 ČRTNA KODA	
		priporočena L	maksimalna L		
024041	C Line 4 DZ ST 1700Nm kk710 (1060)	1325	1413	3838433008556	
024040	C Line 4 DZ ST 1700Nm kk810 (1160)	1475	1580	3838433008549	
021083	C Line 4 DZ ST 1700Nm kk910 (1260)	1625	1747	3838433003537	
020435	C Line 4 DZ ST 1700Nm kk1010 (1360)	1775	1913	3838433002257	
022904	C Line 4 DZ ST 1700Nm kk1210 (1560)	2075	2247	3838433007245	
022905	C Line 4 DZ ST 1700Nm kk1410 (1760)	2375	2580	3838433007252	

ŠIROKOKOTNA KARDANSKA GRED C Line 4 DZ TS 800Nm

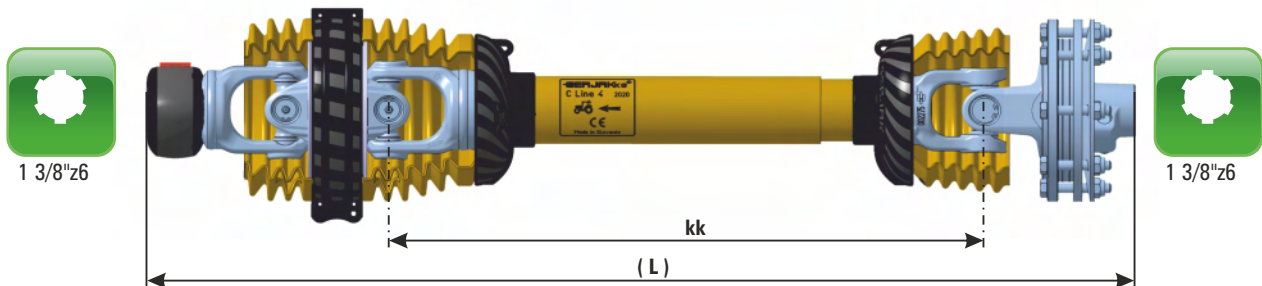

ARTIKEL	OZNAKA	DELOVNA DOLŽINA KARDANSKE GREDI		EAN 13 ČRTNA KODA
		priporočena L	maksimalna L	
013579	C Line 4 DZ TS 800Nm kk710 (1060)	1325	1413	3831111048790
013588	C Line 4 DZ TS 800Nm kk810 (1160)	1475	1580	3831111048882
013597	C Line 4 DZ TS 800Nm kk910 (1260)	1625	1747	3831111048974
013534	C Line 4 DZ TS 800Nm kk1010 (1360)	1775	1913	3831111048349
013543	C Line 4 DZ TS 800Nm kk1210 (1560)	2075	2247	3831111048431
013552	C Line 4 DZ TS 800Nm kk1410 (1760)	2375	2580	3831111048523

*Opcija



ŠIROKOKOTNA KARDANSKA GRED C Line 6 DZ BR+

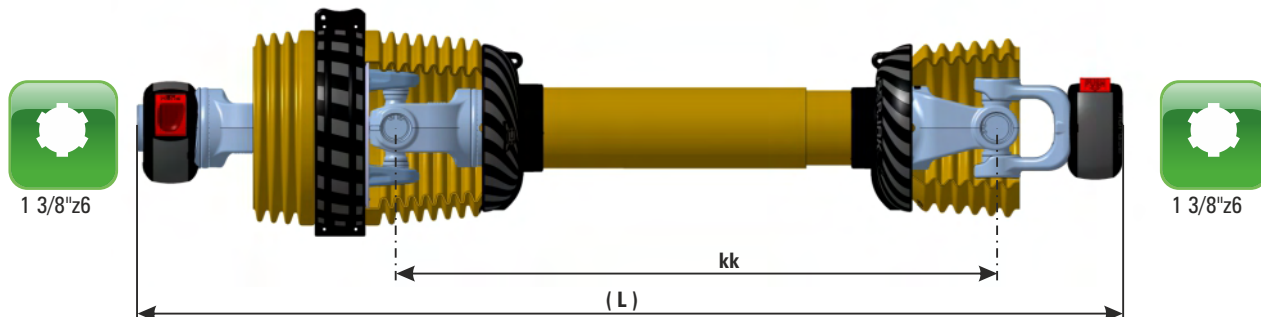

ARTIKEL	OZNAKA	DELOVNA DOLŽINA KARDANSKE GREDI		EAN 13 ČRTNA KODA	
		priporočena L	maksimalna L		
014075	C Line 6 DZ BR+ kk710 (1100)	1348	1430	3831111053756	
014100	C Line 6 DZ BR+ kk810 (1200)	1498	1597	3831111054005	
014125	C Line 6 DZ BR+ kk910 (1300)	1648	1763	3831111054258	
013950	C Line 6 DZ BR+ kk1010 (1400)	1798	1930	3831111052506	
013975	C Line 6 DZ BR+ kk1210 (1600)	2098	2263	3831111052759	
014000	C Line 6 DZ BR+ kk1410 (1800)	2398	2597	3831111053008	

ŠIROKOKOTNA KARDANSKA GRED C Line 6 DZ DZ BR+

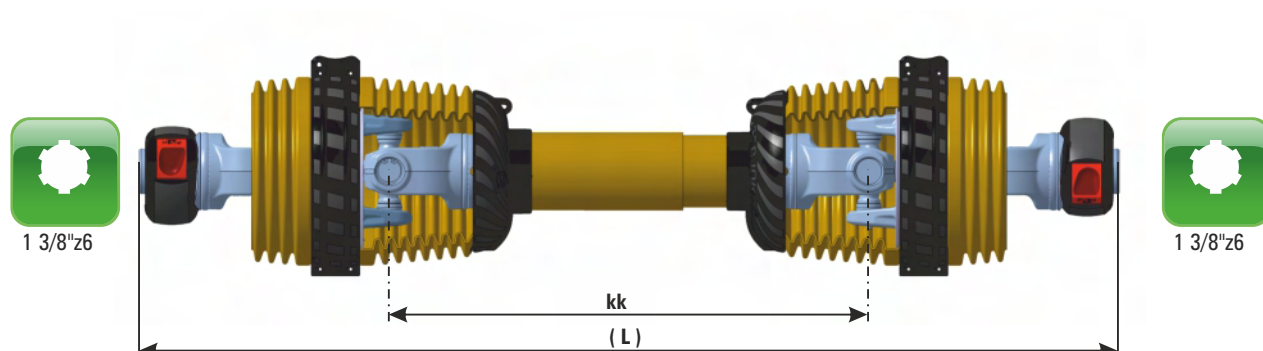

ARTIKEL	OZNAKA	DELOVNA DOLŽINA KARDANSKE GREDI		EAN 13 ČRTNA KODA	
		priporočena L	maksimalna L		
014875	C Line 6 DZ DZ BR+ kk710 (1230)	1478	1560	3831111061751	
014900	C Line 6 DZ DZ BR+ kk810 (1330)	1628	1727	3831111062000	
014925	C Line 6 DZ DZ BR+ kk910 (1430)	1778	1893	3831111062253	
014150	C Line 6 DZ DZ BR+ kk1010 (1530)	1928	2060	3831111054500	
014775	C Line 6 DZ DZ BR+ kk1210 (1730)	2228	2393	3831111060754	
014200	C Line 6 DZ DZ BR+ kk1410 (1930)	2528	2727	3831111055002	

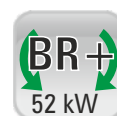

ŠIROKOKOTNA KARDANSKA GRED C Line 6 DZ PS

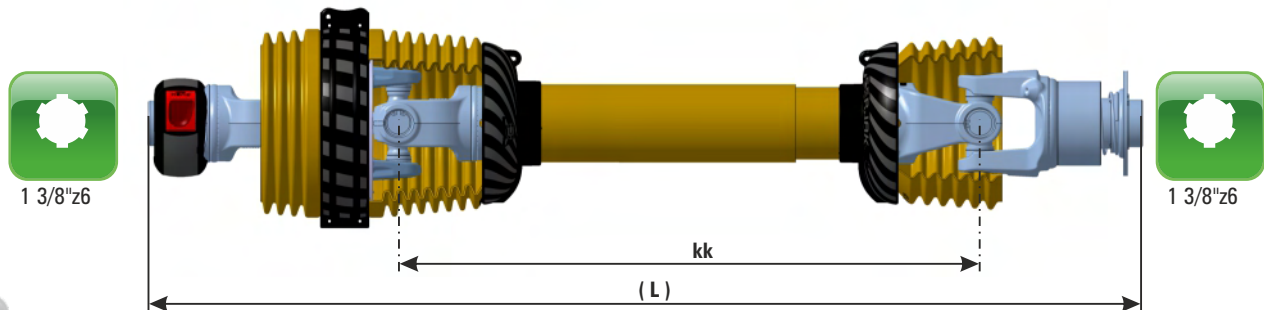

ARTIKEL	OZNAKA	DELOVNA DOLŽINA KARDANSKE GREDI		EAN 13 ČRTNA KODA	
		priporočena L	maksimalna L		
015475	C Line 6 DZ PS kk710 (1140)	1388	1470	3831111067753	
015500	C Line 6 DZ PS kk810 (1240)	1538	1637	3831111068002	
015525	C Line 6 DZ PS kk910 (1340)	1688	1803	3831111068255	
015350	C Line 6 DZ PS kk1010 (1440)	1838	1970	3831111066503	
015375	C Line 6 DZ PS kk1210 (1640)	2138	2303	3831111066756	
015400	C Line 6 DZ PS kk1410 (1840)	2438	2637	3831111067005	

*Opcija



ŠIROKOKOTNA KARDANSKA GRED C Line 6 DZ VS1 1200Nm

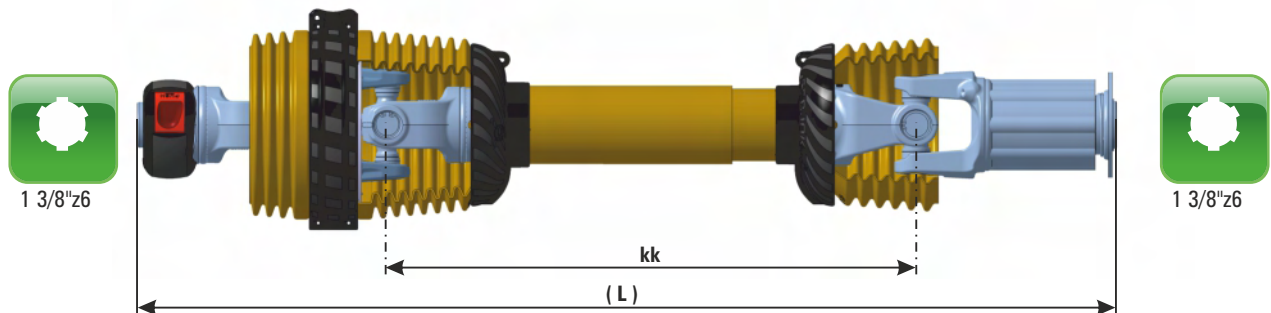

ARTIKEL	OZNAKA	DELOVNA DOLŽINA KARDANSKE GREDI		EAN 13 ČRTNA KODA	Barcode
		priporočena L	maksimalna L		
015875	C Line 6 DZ VS1 1200Nm kk710 (1180)	1428	1510	3831111071750	
015900	C Line 6 DZ VS1 1200Nm kk810 (1280)	1578	1677	3831111072009	
015925	C Line 6 DZ VS1 1200Nm kk910 (1380)	1728	1843	3831111072252	
015750	C Line 6 DZ VS1 1200Nm kk1010 (1480)	1878	2010	3831111070500	
015775	C Line 6 DZ VS1 1200Nm kk1210 (1680)	2178	2343	3831111070753	
015800	C Line 6 DZ VS1 1200Nm kk1410 (1880)	2478	2677	3831111071002	

ŠIROKOKOTNA KARDANSKA GRED C Line 6 DZ VS1 1500Nm

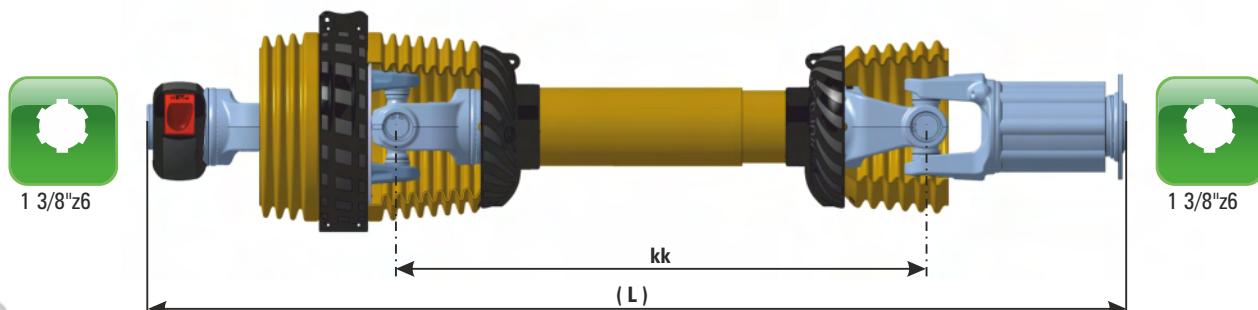

ARTIKEL	OZNAKA	DELOVNA DOLŽINA KARDANSKE GREDI		EAN 13 ČRTNA KODA	BARCODE
		priporočena L	maksimalna L		
016075	C Line 6 DZ VS1 1500Nm kk710 (1200)	1448	1530	3831111073754	
016100	C Line 6 DZ VS1 1500Nm kk810 (1300)	1598	1697	3831111074003	
016125	C Line 6 DZ VS1 1500Nm kk910 (1400)	1748	1863	3831111074256	
015950	C Line 6 DZ VS1 1500Nm kk1010 (1500)	1898	2030	3831111072504	
015975	C Line 6 DZ VS1 1500Nm kk1210 (1700)	2198	2363	3831111072757	
016000	C Line 6 DZ VS1 1500Nm kk1410 (1900)	2498	2697	3831111073006	

ŠIROKOKOTNA KARDANSKA GRED C Line 6 DZ ST 1700Nm

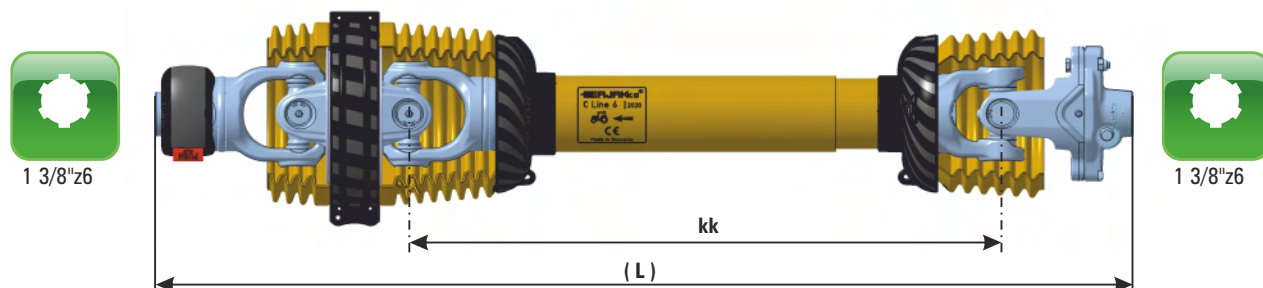

ARTIKEL	OZNAKA	DELOVNA DOLŽINA KARDANSKE GREDI		EAN 13 ČRTNA KODA	BARCODE
		priporočena L	maksimalna L		
029876	C Line 6 DZ ST 1700Nm kk710 (1110)	1358	1440	3838433029742	
029877	C Line 6 DZ ST 1700Nm kk810 (1210)	1508	1607	3838433029759	
028071	C Line 6 DZ ST 1700Nm kk910 (1310)	1658	1773	3838433012850	
029878	C Line 6 DZ ST 1700Nm kk1010 (1410)	1808	1940	3838433029766	
025632	C Line 6 DZ ST 1700Nm kk1210 (1610)	2108	2273	3838433011082	
029879	C Line 6 DZ ST 1700Nm kk1410 (1810)	2408	2607	3838433029773	

ŠIROKOKOTNA KARDANSKA GRED C Line 6 DZ ST 2000Nm

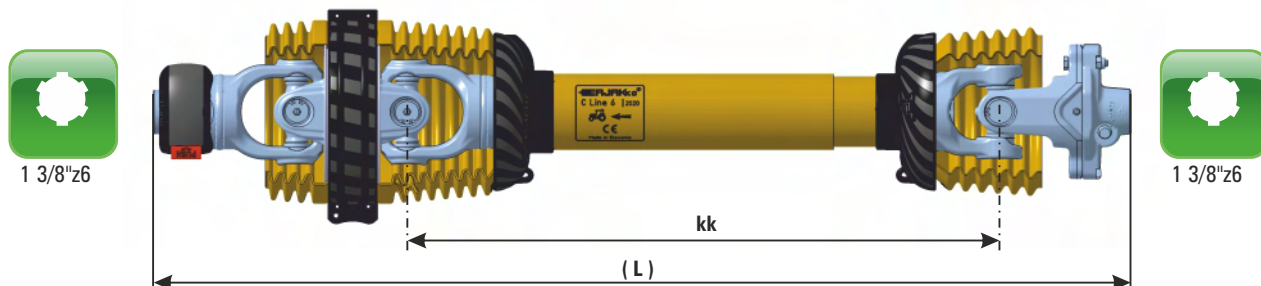

1 3/8"z6

1 3/8"z6

kk

(L)



ARTIKEL	OZNAKA	DELOVNA DOLŽINA KARDANSKE GREDI		EAN 13 ČRTNA KODA
		priporočena L	maksimalna L	
030074	C Line 6 DZ ST 2000Nm kk710 (1110)	1358	1440	3838433031721
030075	C Line 6 DZ ST 2000Nm kk810 (1210)	1508	1607	3838433031738
030076	C Line 6 DZ ST 2000Nm kk910 (1310)	1658	1773	3838433031745
026149	C Line 6 DZ ST 2000Nm kk1010 (1410)	1808	1940	3838433011891
030077	C Line 6 DZ ST 2000Nm kk1210 (1610)	2108	2273	3838433031752
030078	C Line 6 DZ ST 2000Nm kk1410 (1810)	2408	2607	3838433031769

ŠIROKOKOTNA KARDANSKA GRED C Line 6 DZ ST 2400Nm

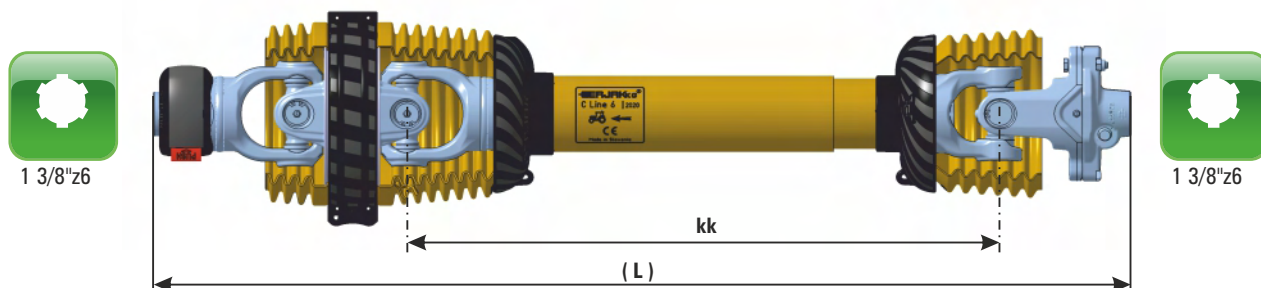

ARTIKEL	OZNAKA	DELOVNA DOLŽINA KARDANSKE GREDI		EAN 13 ČRTNA KODA	BARCODE
		priporočena L	maksimalna L		
030273	C Line 6 DZ ST 2400Nm kk710 (1110)	1358	1440	3838433033718	
030274	C Line 6 DZ ST 2400Nm kk810 (1210)	1508	1607	3838433033725	
030275	C Line 6 DZ ST 2400Nm kk910 (1310)	1658	1773	3838433033732	
030276	C Line 6 DZ ST 2400Nm kk1010 (1410)	1808	1940	3838433033749	
030277	C Line 6 DZ ST 2400Nm kk1210 (1610)	2108	2273	3838433033756	
030278	C Line 6 DZ ST 2400Nm kk1410 (1810)	2408	2607	3838433033763	

ŠIROKOKOTNA KARDANSKA GRED C Line 6 DZ ST 2700Nm

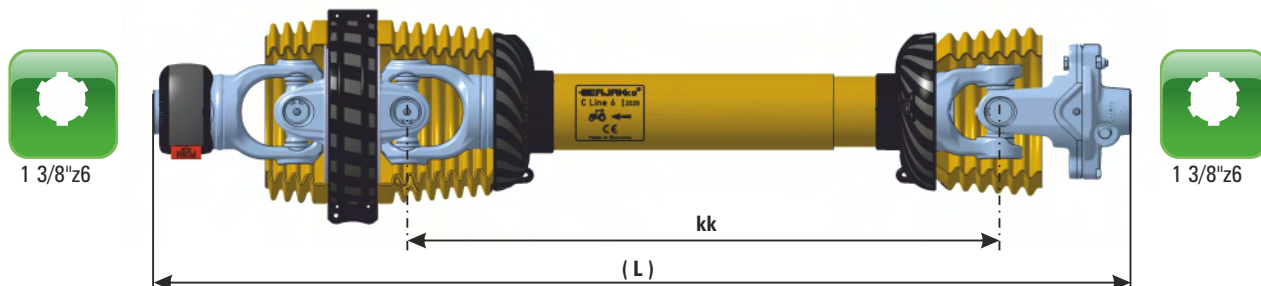

1 3/8"z6

1 3/8"z6

kk

(L)



ARTIKEL	OZNAKA	DELOVNA DOLŽINA KARDANSKE GREDI		EAN 13 ČRTNA KODA	EAN 13 ČRTNA KODA
		priporočena L	maksimalna L		
024030	C Line 6 DZ ST 2700Nm kk710 (1110)	1358	1440	3838433008464	
024029	C Line 6 DZ ST 2700Nm kk810 (1210)	1508	1607	3838433008457	
024028	C Line 6 DZ ST 2700Nm kk910 (1310)	1658	1773	3838433008440	
020436	C Line 6 DZ ST 2700Nm kk1010 (1410)	1808	1940	3838433002264	
022418	C Line 6 DZ ST 2700Nm kk1210 (1610)	2108	2273	3838433006323	
020887	C Line 6 DZ ST 2700Nm kk1410 (1810)	2408	2607	3838433003346	

ŠIROKOKOTNA KARDANSKA GRED C Line 6 DZ TS 1200Nm

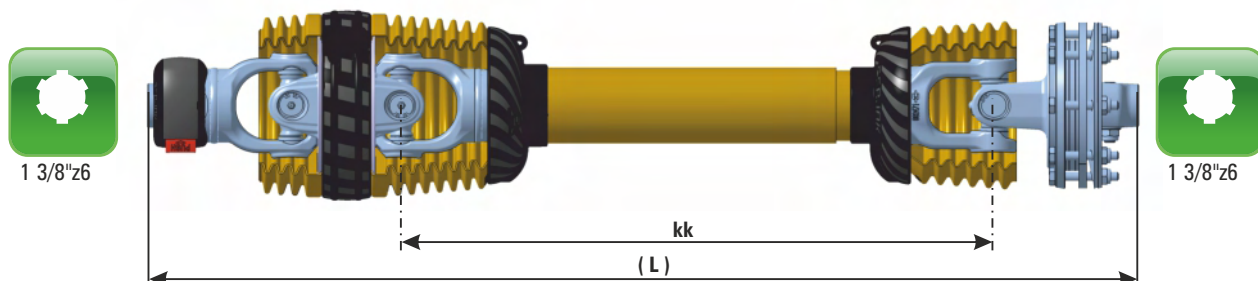

ARTIKEL	OZNAKA	DELOVNA DOLŽINA KARDANSKE GREDI		EAN 13 ČRTNA KODA
		priporočena L	maksimalna L	
015675	C Line 6 DZ TS 1200Nm kk710 (1130)	1378	1460	3831111069757
015700	C Line 6 DZ TS 1200Nm kk810 (1230)	1528	1627	3831111070005
015725	C Line 6 DZ TS 1200Nm kk910 (1330)	1678	1793	3831111070258
015550	C Line 6 DZ TS 1200Nm kk1010 (1430)	1828	1960	3831111068507
015575	C Line 6 DZ TS 1200Nm kk1210 (1630)	2128	2293	3831111068750
015600	C Line 6 DZ TS 1200Nm kk1410 (1830)	2428	2627	3831111069009

*Opcija



ŠIROKOKOTNA KARDANSKA GRED C Line 8 DZ BR+

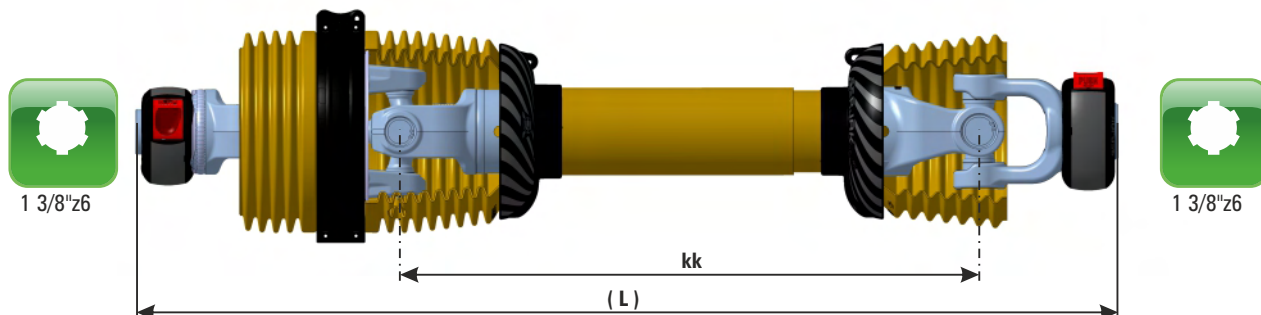

ARTIKEL	OZNAKA	DELOVNA DOLŽINA KARDANSKE GREDI		EAN 13 ČRTNA KODA	EAN 13 ČRTNA KODA
		priporočena L	maksimalna L		
016475	C Line 8 DZ BR+ kk710 (1140)	1365	1440	3831111077752	
016500	C Line 8 DZ BR+ kk810 (1240)	1515	1607	3831111078001	
016525	C Line 8 DZ BR+ kk910 (1340)	1665	1773	3831111078254	
016350	C Line 8 DZ BR+ kk1010 (1440)	1815	1940	3831111076502	
016375	C Line 8 DZ BR+ kk1210 (1640)	2115	2273	3831111076755	
016400	C Line 8 DZ BR+ kk1410 (1840)	2415	2607	3831111077004	

ŠIROKOKOTNA KARDANSKA GRED C Line 8 DZ DZ BR+

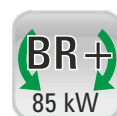
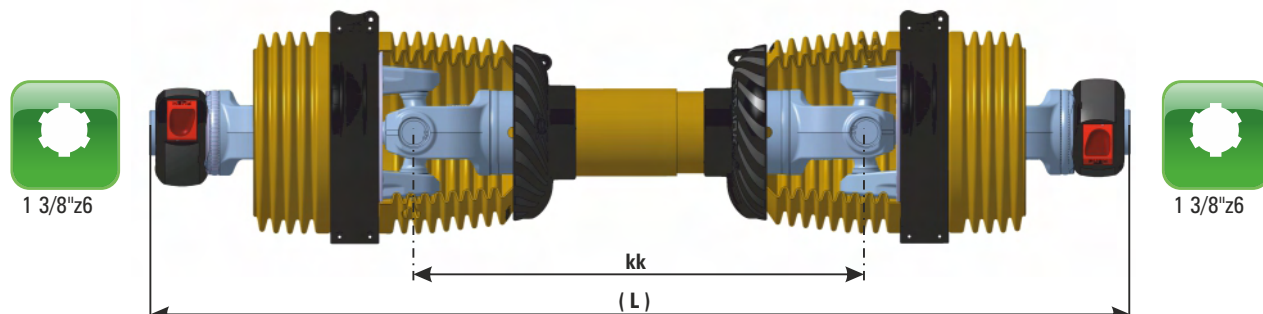

ARTIKEL	OZNAKA	DELOVNA DOLŽINA KARDANSKE GREDI		EAN 13 ČRTNA KODA	EAN 13 ČRTNA KODA
		priporočena L	maksimalna L		
017275	C Line 8 DZ DZ BR+ kk710 (1270)	1495	1570	3831111085757	
017300	C Line 8 DZ DZ BR+ kk810 (1370)	1645	1737	3831111086006	
017325	C Line 8 DZ DZ BR+ kk910 (1470)	1795	1903	3831111086259	
016550	C Line 8 DZ DZ BR+ kk1010 (1570)	1945	2070	3831111078506	
016575	C Line 8 DZ DZ BR+ kk1210 (1770)	2245	2403	3831111078759	
017200	C Line 8 DZ DZ BR+ kk1410 (1970)	2545	2737	3831111085009	

ŠIROKOKOTNA KARDANSKA GRED C Line 8 DZ PS

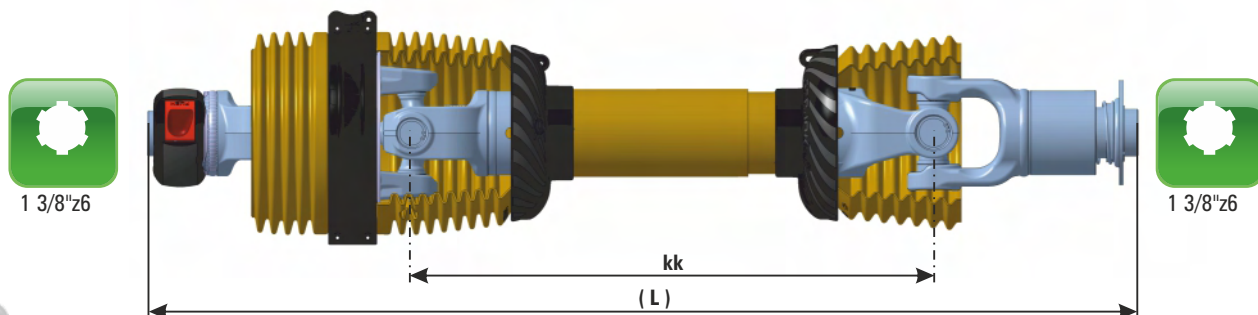

ARTIKEL	OZNAKA	DELOVNA DOLŽINA KARDANSKE GREDE		EAN 13 ČRTNA KODA	EAN 13 ČRTNA KODA
		priporočena L	maksimalna L		
017675	C Line 8 DZ PS kk710 (1210)	1435	1510	3831111089755	
017700	C Line 8 DZ PS kk810 (1310)	1585	1677	3831111090003	
017725	C Line 8 DZ PS kk910 (1410)	1735	1843	3831111090256	
017550	C Line 8 DZ PS kk1010 (1510)	1885	2010	3831111088505	
017575	C Line 8 DZ PS kk1210 (1710)	2185	2343	3831111088758	
017600	C Line 8 DZ PS kk1410 (1910)	2485	2677	3831111089007	

*Opcija



ŠIROKOKOTNA KARDANSKA GRED C Line 8 DZ VS1 1500Nm

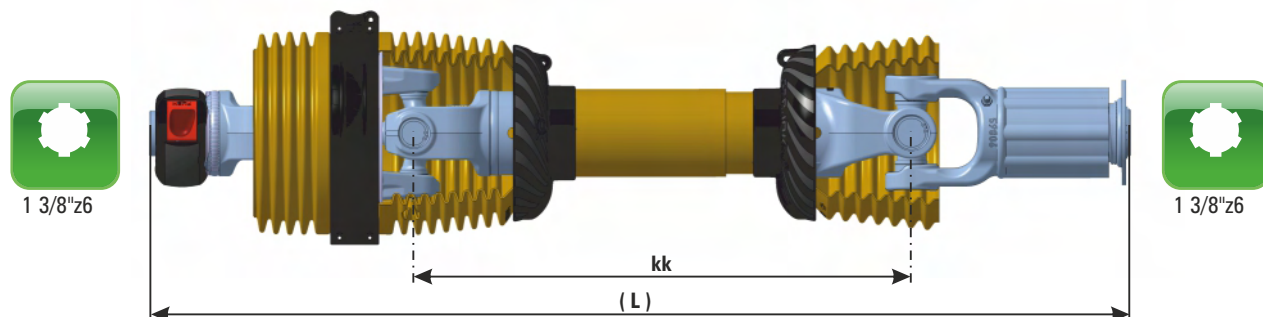

ARTIKEL	OZNAKA	DELOVNA DOLŽINA KARDANSKE GREDI		EAN 13 ČRTNA KODA
		priporočena L	maksimalna L	
024022	C Line 8 DZ VS1 1500Nm kk710 (1240)	1465	1540	3838433008389
024023	C Line 8 DZ VS1 1500Nm kk810 (1340)	1615	1707	3838433008396
024024	C Line 8 DZ VS1 1500Nm kk910 (1440)	1765	1873	3838433008402
024025	C Line 8 DZ VS1 1500Nm kk1010 (1540)	1915	2040	3838433008419
024026	C Line 8 DZ VS1 1500Nm kk1210 (1740)	2215	2373	3838433008426
024027	C Line 8 DZ VS1 1500Nm kk1410 (1940)	2515	2707	3838433008433

ŠIROKOKOTNA KARDANSKA GRED C Line 8 DZ ST 2400Nm

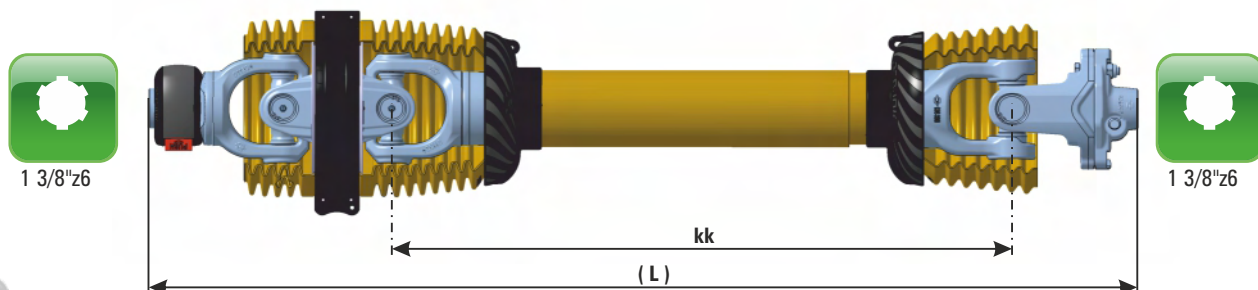

ARTIKEL	OZNAKA	DELOVNA DOLŽINA KARDANSKE GREDI		EAN 13 ČRTNA KODA	EAN 13 ČRTNA KODA
		priporočena L	maksimalna L		
030663	C Line 8 DZ ST 2400Nm kk710 (1140)	1365	1440	3838433037617	
030664	C Line 8 DZ ST 2400Nm kk810 (1240)	1515	1607	3838433037624	
030665	C Line 8 DZ ST 2400Nm kk910 (1340)	1665	1773	3838433037631	
030666	C Line 8 DZ ST 2400Nm kk1010 (1440)	1815	1940	3838433037648	
030667	C Line 8 DZ ST 2400Nm kk1210 (1640)	2115	2273	3838433037655	
030668	C Line 8 DZ ST 2400Nm kk1410 (1840)	2415	2607	3838433037662	

ŠIROKOKOTNA KARDANSKA GRED C Line 8 DZ ST 2700Nm

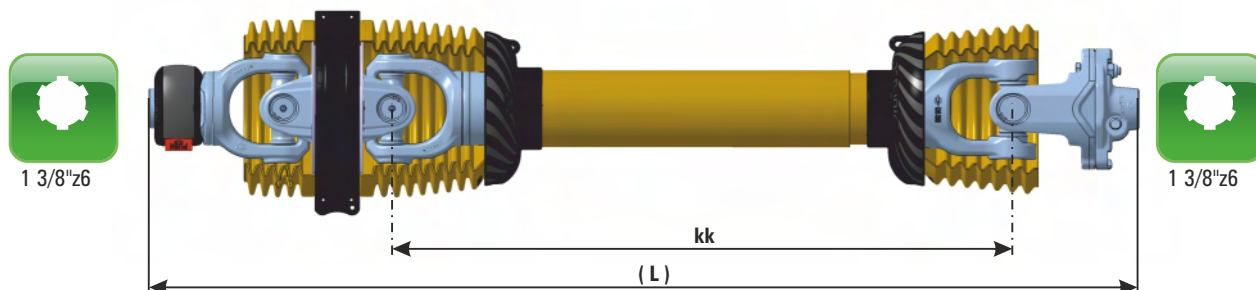

ARTIKEL	OZNAKA	DELOVNA DOLŽINA KARDANSKE GREDI		EAN 13 ČRTNA KODA	BARCODE
		priporočena L	maksimalna L		
030863	C Line 8 DZ ST 2700Nm kk710 (1140)	1365	1440	3838433039611	
030864	C Line 8 DZ ST 2700Nm kk810 (1240)	1515	1607	3838433039628	
028122	C Line 8 DZ ST 2700Nm kk910 (1340)	1665	1773	3838433012867	
030865	C Line 8 DZ ST 2700Nm kk1010 (1440)	1815	1940	3838433039635	
030866	C Line 8 DZ ST 2700Nm kk1210 (1640)	2115	2273	3838433039642	
030867	C Line 8 DZ ST 2700Nm kk1410 (1840)	2415	2607	3838433039659	

ŠIROKOKOTNA KARDANSKA GRED C Line 8 DZ ST 3000Nm

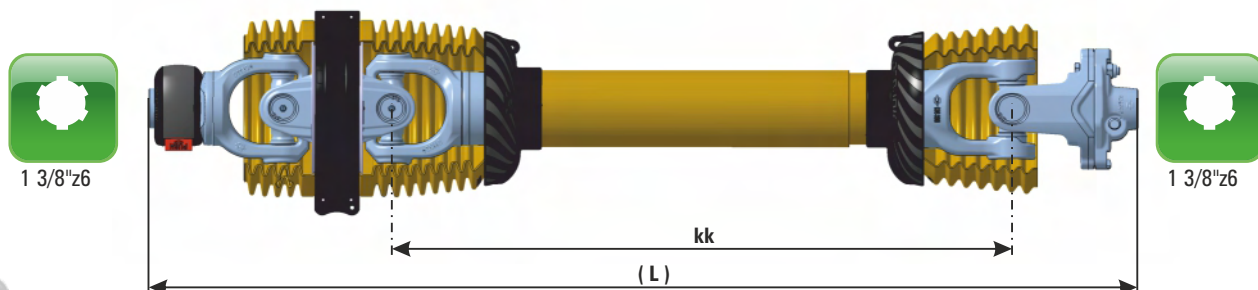

ARTIKEL	OZNAKA	DELOVNA DOLŽINA KARDANSKE GREDI		EAN 13 ČRTNA KODA	EAN 13 ČRTNA KODA
		priporočena L	maksimalna L		
024015	C Line 8 DZ ST 3000Nm kk710 (1140)	1365	1440	3838433008310	
024013	C Line 8 DZ ST 3000Nm kk810 (1240)	1515	1607	3838433008303	
024012	C Line 8 DZ ST 3000Nm kk910 (1340)	1665	1773	3838433008297	
022913	C Line 8 DZ ST 3000Nm kk1010 (1440)	1815	1940	3838433007313	
022914	C Line 8 DZ ST 3000Nm kk1210 (1640)	2115	2273	3838433007320	
022915	C Line 8 DZ ST 3000Nm kk1410 (1840)	2415	2607	3838433007337	

ŠIROKOKOTNA KARDANSKA GRED C Line 8 DZ ST 3500Nm

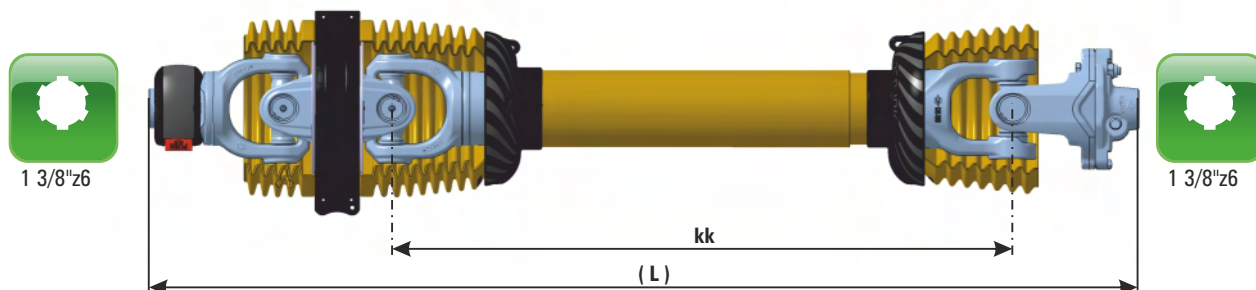

ARTIKEL	OZNAKA	DELOVNA DOLŽINA KARDANSKE GREDI		EAN 13 ČRTNA KODA
		priporočena L	maksimalna L	
024016	C Line 8 DZ ST 3500Nm kk710 (1140)	1365	1440	3838433008327
024017	C Line 8 DZ ST 3500Nm kk810 (1240)	1515	1607	3838433008334
024018	C Line 8 DZ ST 3500Nm kk910 (1340)	1665	1773	3838433008341
024019	C Line 8 DZ ST 3500Nm kk1010 (1440)	1815	1940	3838433008358
024020	C Line 8 DZ ST 3500Nm kk1210 (1640)	2115	2273	3838433008365
024021	C Line 8 DZ ST 3500Nm kk1410 (1840)	2415	2607	3838433008372



ŠIROKOKOTNA KARDANSKA GRED C Line 8 DZ TS 1800Nm

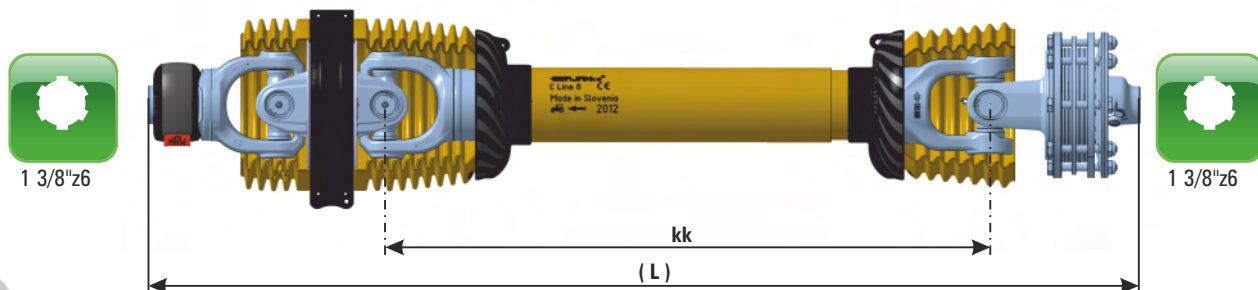

ARTIKEL	OZNAKA	DELOVNA DOLŽINA KARDANSKE GREDI		EAN 13 ČRTNA KODA	BARCODE
		priporočena L	maksimalna L		
017875	C Line 8 DZ TS 1800Nm kk710 (1170)	1395	1470	3831111091758	
017900	C Line 8 DZ TS 1800Nm kk810 (1270)	1545	1637	3831111092007	
017925	C Line 8 DZ TS 1800Nm kk910 (1370)	1695	1803	3831111092250	
017750	C Line 8 DZ TS 1800Nm kk1010 (1470)	1845	1970	3831111090508	
017775	C Line 8 DZ TS 1800Nm kk1210 (1670)	2145	2303	3831111090751	
017800	C Line 8 DZ TS 1800Nm kk1410 (1870)	2445	2637	3831111091000	

*Opcija



ŠIROKOKOTNA KARDANSKA GRED C Line 8 DZ TS 2600Nm

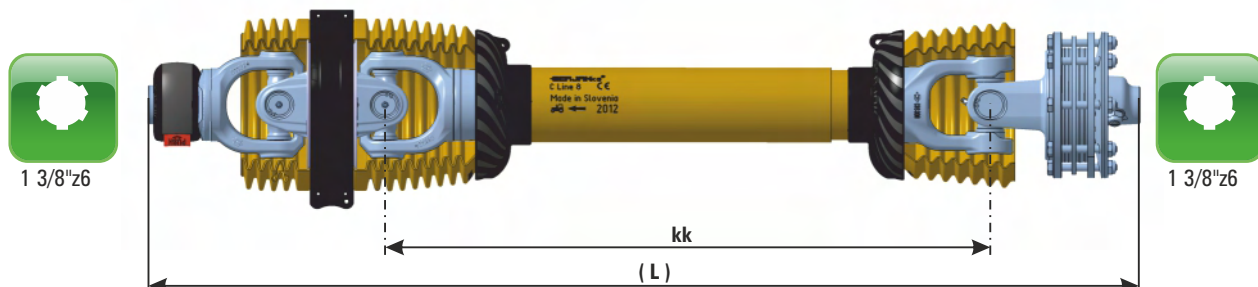

ARTIKEL	OZNAKA	DELOVNA DOLŽINA KARDANSKE GREDI		EAN 13 ČRTNA KODA	EAN 13 ČRTNA KODA
		priporočena L	maksimalna L		
018075	C Line 8 DZ TS 2600Nm kk710 (1170)	1395	1470	3831111093752	
018100	C Line 8 DZ TS 2600Nm kk810 (1270)	1545	1637	3831111094001	
018125	C Line 8 DZ TS 2600Nm kk910 (1370)	1695	1803	3831111094254	
017950	C Line 8 DZ TS 2600Nm kk1010 (1470)	1845	1970	3831111092502	
017975	C Line 8 DZ TS 2600Nm kk1210 (1670)	2145	2303	3831111092755	
018000	C Line 8 DZ TS 2600Nm kk1410 (1870)	2445	2637	3831111093004	

*Opcija



REZERVNI DELI KARDANSKE GREDI

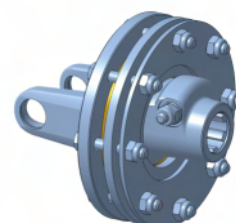
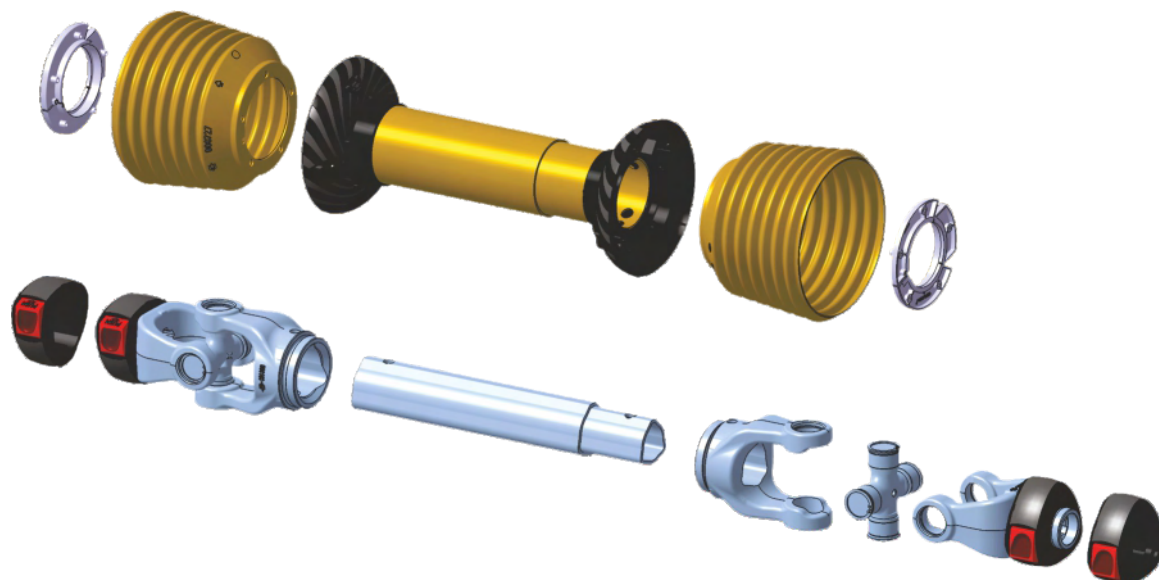

REZERVNI DELI KARDANSKE GREDI

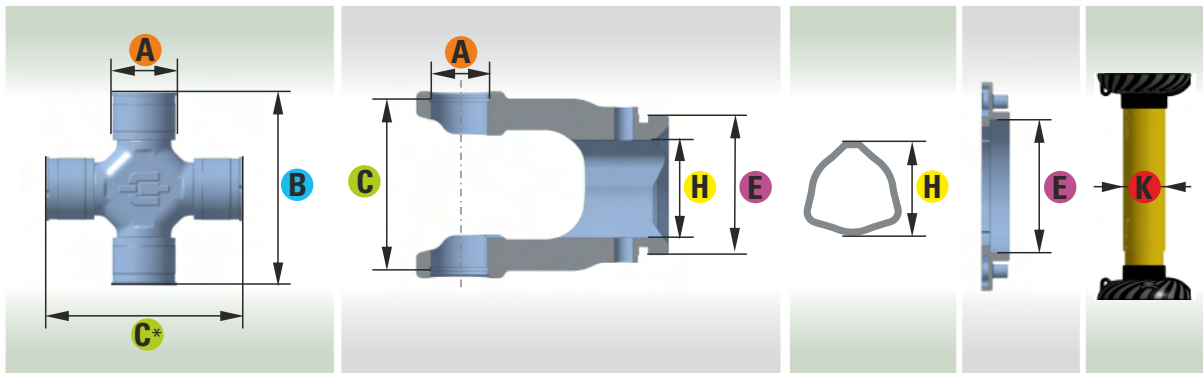

	A	B	C*	A	C	E	H	H	E	K
1	22	55	57*	22	57	47	32,5/26,5	32,5/26,5	47	55,5/50
2	23,8	61,3	63,7*	23,8	63,7	61	36/29	36/29	61	67/61,5
4	27	74,6	77*	27	77	61	43,5/36,5	43,5/36,5	61	67/61,5
6	30,2	91,4	94,4*	30,2	94,4	76	53,5/45,5	53,5/45,5	76	82/76
8	34,9	106	109,45*	34,9	109,45	83,8	62,6/53,6	62,6/53,6	83,8	92/86

*mera z vskočnikom



REZERVNI DELI KARDANSKIH GREDI

C Line 1

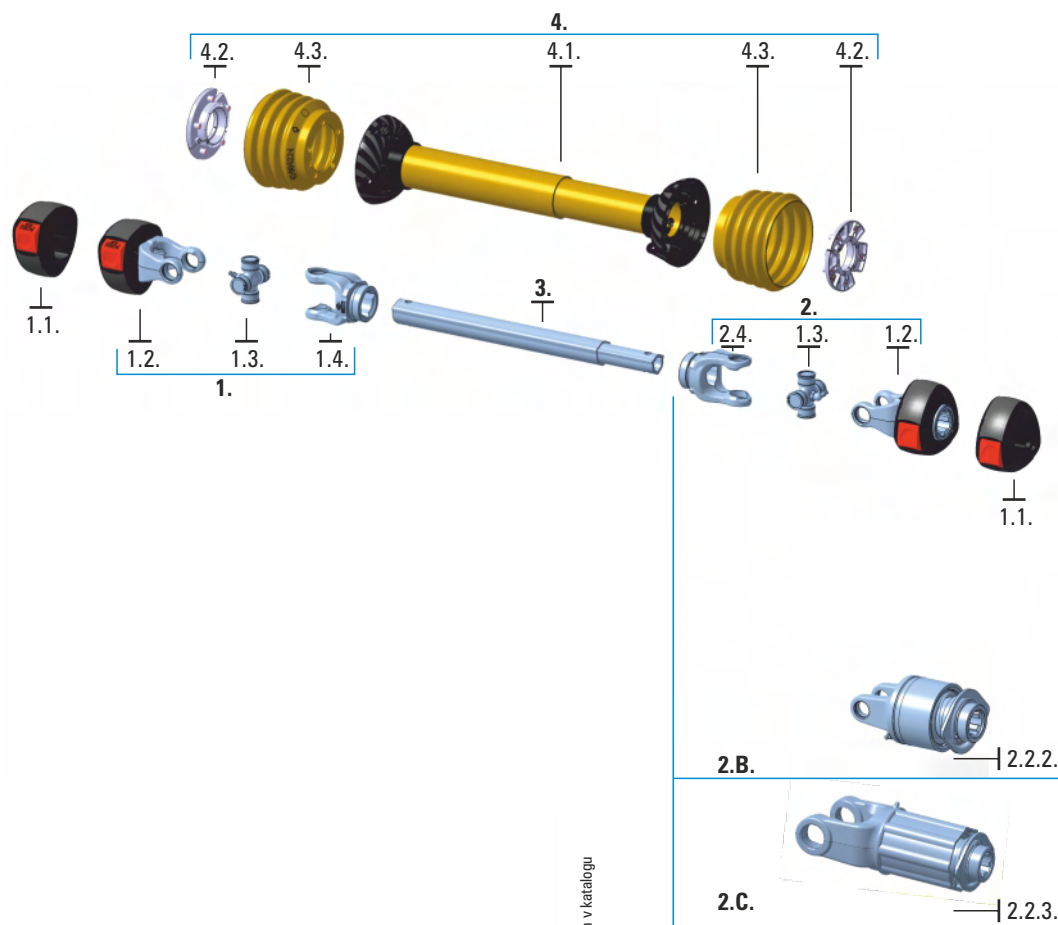

stran v katalogu

ŠT.	OPIS	
1.	Kardanski zglob C Line 1 BR TZ	93
1.1.	Okrov C Line 1	112
1.2.	Vilica priključna C Line 1	99
1.3.	Križ C Line 1	98
1.4.	Vilica cevna C Line 1 TZ	100
2.	Kardanski zglob C Line 1 BR TN	93
1.1.	Okrov C Line 1	112
1.2.	Vilica priključna C Line 1	99
1.3.	Križ C Line 1	98
2.4.	Vilica cevna C Line 1 TN	100
2.B.	Kardanski zglob C Line 1 PS TN / C Line 1 PSL TN	93
2.2.2.	Sklopka C Line 1 PS / C Line 1 PSL	101
1.3.	Križ C Line 1	98
2.4.	Vilica cevna	100
2.C.	Kardanski zglob C Line 1 VS1 TN	93
2.2.3.	Sklopka C Line 1 VS1	103
1.3.	Križ C Line 1	98
2.4.	Vilica cevna C Line 1 TN	100
3.	Cev kovinska 1 kpl	107
4.	Zaščita C Line 1	113
4.1.	Cev z ohišjem C Line 1	119
4.2.	Ležaj PA C Line 1	118
4.3.	Kapa C Line 1	118
	Veriga Typ C Line	118



C Line 2

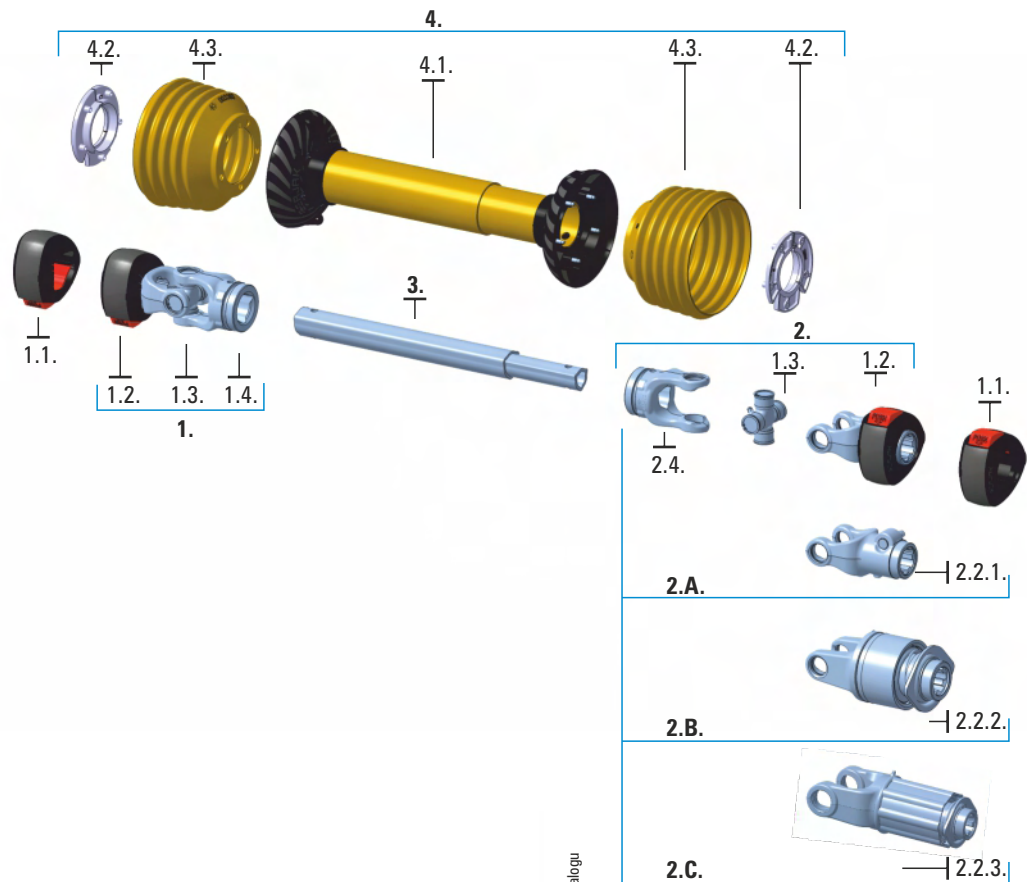

stran v katalogu

ŠT.	OPIS	
1.	Kardanski zglob C Line 2 BR TZ	94
1.1.	Okrov C Line 2	112
1.2.	Vilica priključna C Line 2	99
1.3.	Križ C Line 2	98
1.4.	Vilica cevna C Line 2 TZ	100
2.	Kardanski zglob C Line 2 BR TN	94
1.1.	Okrov C Line 2	112
1.2.	Vilica priključna C Line 2	99
1.3.	Križ C Line 2	98
2.4.	Vilica cevna	100
2.B.	Kardanski zglob C Line 2 PS TN / C Line 2 PSL TN	94
2.2.2.	Sklopka C Line 2 PS / C Line 2 PSL	101
1.3.	Križ C Line 2	98
2.4.	Vilica cevna	100
2.C.	Kardanski zglob C Line 2 VS1 TN	94
2.2.3.	Sklopka C Line 2 VS1	103
1.3.	Križ C Line 2	98
2.4.	Vilica cevna C Line 2 TN	100
3.	Cev kovinska 2 kpl	108
4.	Zaščita C Line 2	114
4.1.	Cev z ohišjem C Line 2	120
4.2.	Ležaj PA C Line 2	118
4.3.	Kapa C Line 2	118
	Veriga Typ C Line	118

REZERVNI DELI KARDANSKIH GREDI

C Line 4

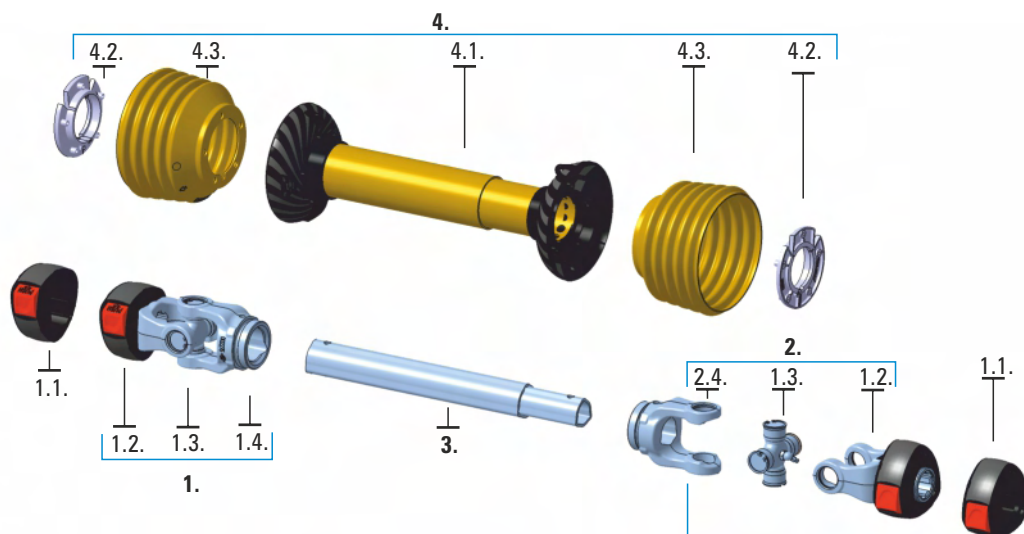

stran v katalogu

ŠT.	OPIS	
1.	Kardanski zglob C Line 4 BR TZ	95
1.1.	Okrov C Line 4	112
1.2.	Vilica priključna C Line 4	99
1.3.	Križ C Line 4	98
1.4.	Vilica cevna C Line 4 TZ	100
2.	Kardanski zglob C Line 4 BR TN	95
1.1.	Okrov C Line 4	112
1.2.	Vilica priključna C Line 4	99
1.3.	Križ C Line 4	98
2.4.	Vilica cevna C Line 4 TN	100
2.B.	Kardanski zglob C Line 4 PS TN / C Line 4 PSL TN	95
2.2.2.	Sklopka C Line 4 PS / C Line 4 PSL	101
1.3.	Križ C Line 4	98
2.4.	Vilica cevna C Line 4 TN	100
2.C.	Kardanski zglob C Line 4 VS1 TN	95
2.2.3.	Sklopka C Line 4 VS1	103
2.3.	Križ C Line 4	98
2.4.	Vilica cevna C Line 4 TN	100
2.D.	Kardanski zglob C Line 4 ST TN	95
2.2.4.	Sklopka C Line 4 ST	105
1.3.	Križ C Line 4	98
2.4.	Vilica cevna C Line 4 TN	100
2.E.	Kardanski zglob C Line 4 TS TN	95
2.2.5.	Sklopka C Line 4 TS	106
1.3.	Križ C Line 4	98
2.4.	Vilica cevna C Line 4 TN	100
3.	Cev kovinska 4 kpl	109
4.	Zaščita C Line 4	115
4.1.	Cev z ohišjem C Line 4	121
4.2.	Ležaj PA C Line 4	118
4.3.	Kapa C Line 4	118
	Veriga Typ C Line	118

2.B. —| 2.2.2.

2.C. —| 2.2.3.

2.D. —| 2.2.4.

2.E. —| 2.2.5.

C Line 6

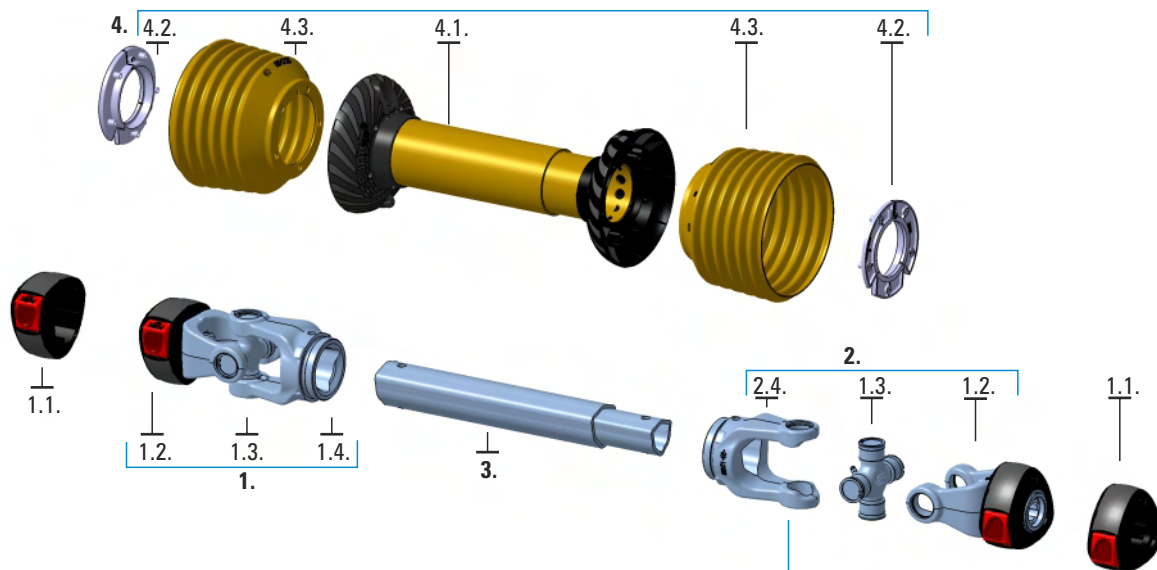

ŠT.	OPIS	stran v katalogu
1.	Kardanski zglob C Line 6 BR TZ	96
1.1.	Okrov C Line 6	112
1.2.	Vilica priključna C Line 6	99
1.3.	Križ C Line 6	98
1.4.	Vilica cevna C Line 6 TZ	100
2.	Kardanski zglob C Line 6 BR TN	96
1.1.	Okrov C Line 6	112
1.2.	Vilica priključna C Line 6	99
1.3.	Križ C Line 6	98
2.4.	Vilica cevna C Line 6 TN	100
2.B.	Kardanski zglob C Line 6 PS TN / C Line 6 PSL TN	96
2.2.2.	Sklopka C Line 6 PS / C Line 6 PSL	101
1.3.	Križ C Line 6	98
2.4.	Vilica cevna C Line 6 TN	100
2.C.	Kardanski zglob C Line 6 VS1 TN	96
2.2.3.	Sklopka C Line 6 VS1	104
1.3.	Križ C Line 6	98
2.4.	Vilica cevna C Line 6 TN	100
2.D.	Kardanski zglob C Line 6 ST TN	96
2.2.4.	Sklopka C Line 6 ST	105
1.3.	Križ C Line 6	98
2.4.	Vilica cevna C Line 6 TN	100
2.E.	Kardanski zglob C Line 6 TS TN	96
2.2.5.	Sklopka C Line 6 TS	106
1.3.	Križ C Line 6	98
2.4.	Vilica cevna C Line 6 TN	100
3.	Cev kovinska 6 kpl	110
4.	Zaščita C Line 6	116
4.1.	Cev z ohišjem C Line 6	122
4.2.	Ležaj PA C Line 6	118
4.3.	Kapa C Line 6	118
	Veriga Typ C Line	118

2.B. 2.2.2.

2.C. 2.2.3.

2.D. 2.2.4.

2.E. 2.2.5.

REZERVNI DELI KARDANSKIH GREDI

C Line 8

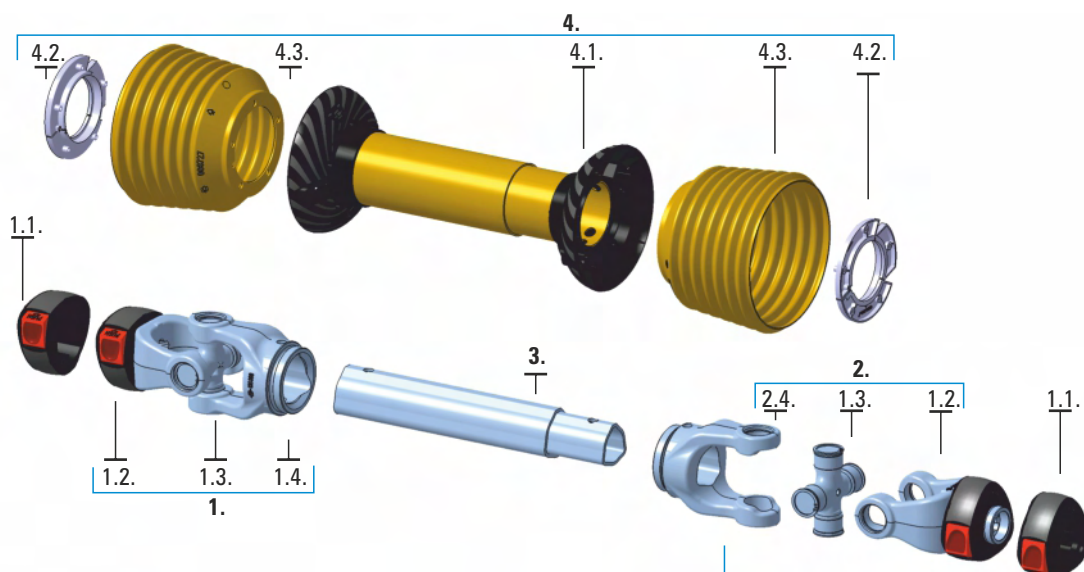

ŠT.	OPIS	stran v katalogu
1.	Kardanski zglob C Line 8 BR TZ	97
1.1.	Okrov C Line 8	112
1.2.	Vilica priključna C Line 8	99
1.3.	Križ C Line 8	98
1.4.	Vilica cevna C Line 8 TZ	100
2.	Kardanski zglob C Line 8 BR TN	97
1.1.	Okrov C Line 8	112
1.2.	Vilica priključna C Line 8	99
1.3.	Križ C Line 8	98
2.4.	Vilica cevna C Line 8 TN	100
2.B.	Kardanski zglob C Line 8 PS TN / C Line 8 PSL TN	97
2.2.2.	Sklopka C Line 8 PS / C Line 8 PSL	101
1.3.	Križ C Line 8	98
2.4.	Vilica cevna C Line 8 TN	100
2.C.	Kardanski zglob C Line 8 VS1 TN	97
2.2.3.	Sklopka C Line 8 VS1	104
1.3.	Križ C Line 8	98
2.4.	Vilica cevna C Line 8 TN	100
2.D.	Kardanski zglob C Line 8 ST TN	97
2.2.4.	Sklopka C Line 8 ST	105
1.3.	Križ C Line 8	98
2.4.	Vilica cevna C Line 8 TN	100
2.E.	Kardanski zglob C Line 8 TS TN	97
2.2.5.	Sklopka C Line 8 TS	106
1.3.	Križ C Line 8	98
2.4.	Vilica cevna c Line 8 TN	100
3.	Cev kovinska 8 kpl	111
4.	Zaščita C Line 8	117
4.1.	Cev z ohišjem C Line 8	123
4.2.	Ležaj PA C Line 8	118
4.3.	Kapa C Line 8	118
	Veriga Typ C Line	118

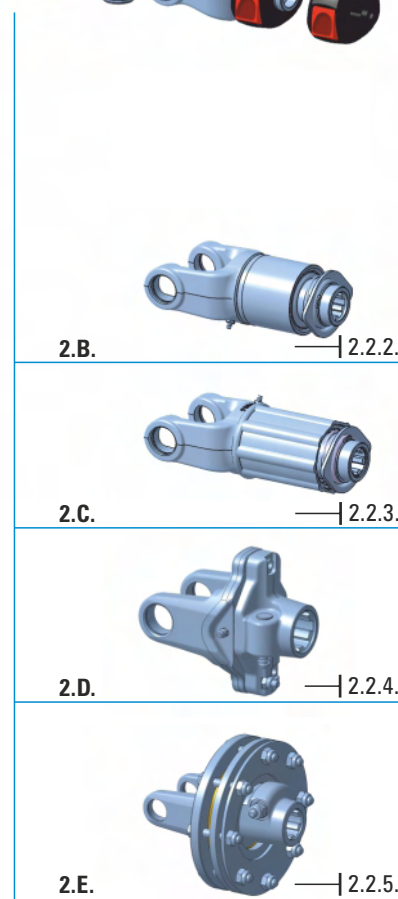

REZERVNI DELI KARDANSKIH GREDI KARDANSKI ZGLOB 1

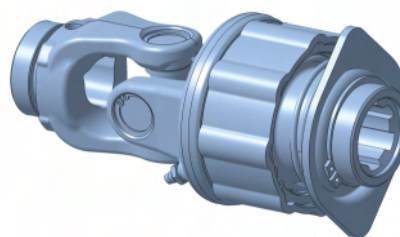
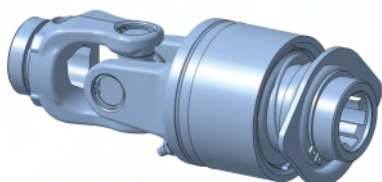
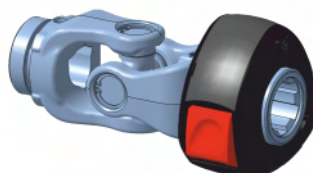

ARTIKEL OPIS

007169R C Line 1 BR+ TN 1 3/8"z6



3831111020925

EAN 13 ČRTNA KODA



1 3/8"z6

002875R C Line 1 BR TZ 1 3/8"z6



3831111016300



006865R C Line 1 PS TN 1 3/8"z6



3831111018656



006911R C Line 1 PSL TN 1 3/8"z6



3831111019097



006948R C Line 1 VS1 300Nm TN 1 3/8"z6



3831111019455



006949R C Line 1 VS1 450Nm TN 1 3/8"z6



3831111019462



REZERVNI DELI KARDANSKIH GREDI

KARDANSKI ZGLOB 2

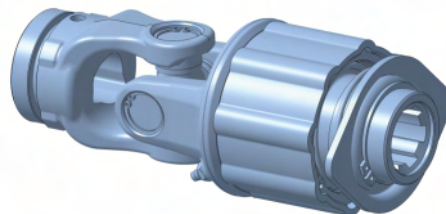
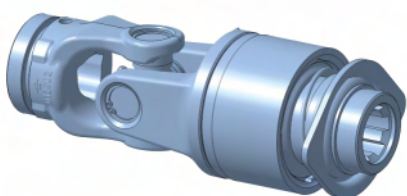

1 3/8"z6

ARTIKEL OPIS

EAN 13 ČRTNA KODA

ARTIKEL	OPIS			EAN 13 ČRTNA KODA
018471R	C Line 2 BR+ TN 1 3/8"z6		3831111094858	
012605R	C Line 2 BR TZ 1 3/8"z6		3831111041685	
018761R	C Line 2 PS TN 1 3/8"z6		3831111095602	
018766R	C Line 2 PSL TN 1 3/8"z6		3831111095633	
018770R	C Line 2 V1S 450Nm TN 1 3/8"z6		3831111095664	
018772R	C Line 2 VS1 600Nm TN 1 3/8"z6		3831111095688	

REZERVNI DELI KARDANSKIH GREDI KARDANSKI ZGLOB 4

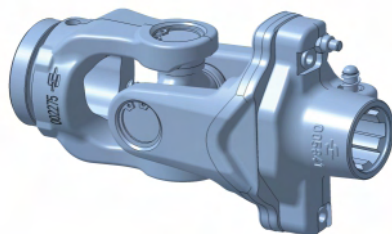
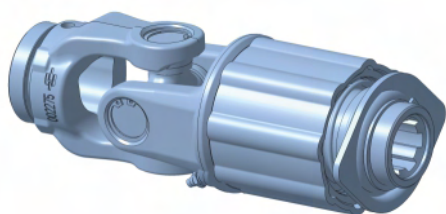
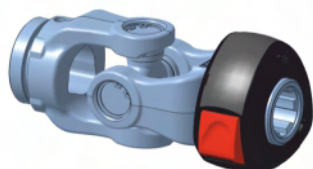

ARTIKEL OPIS

007185R C Line 4 BR+ TN 1 3/8"z6



3831111021083



002877R C Line 4 BR TZ 1 3/8"z6



3831111016522



006695R C Line 4 PS TN 1 3/8"z6



3831111016546



006711R C Line 4 PSL TN 1 3/8"z6



3831111016676



006727R C Line 4 VS1 600Nm TN 1 3/8"z6



3831111016836



006743R C Line 4 VS1 900Nm TN 1 3/8"z6



3831111017017



006759R C Line 4 ST 900Nm TN 1 3/8"z6



3831111017178



024291R C Line 4 ST 1300Nm TN 1 3/8"z6



3838433008723



006775R C Line 4 ST 1700Nm TN 1 3/8"z6



3831111017338



006799R C Line 4 TS 800Nm TN 1 3/8"z6



3831111017529



REZERVNI DELI KARDANSKIH GREDI

KARDANSKI ZGLOB 6

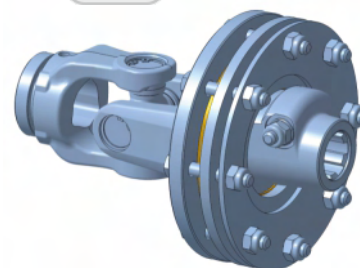
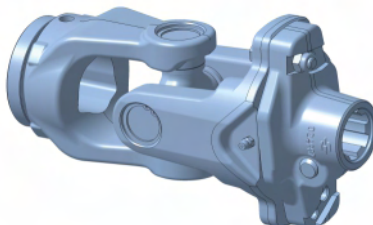
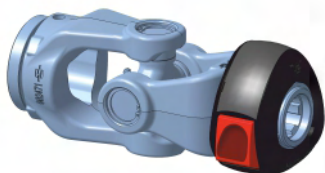

1 3/8"z6

ARTIKEL	OPIS		EAN 13 ČRTNA KODA
007206R	C Line 6 BR+ TN 1 3/8"z6		3831111021243
002879R	C Line 6 BR TZ 1 3/8"z6		3831111016539
006827R	C Line 6 PS TN 1 3/8"z6		3831111017826
006862R	C Line 6 PSL TN 1 3/8"z6		3831111018625
006896R	C Line 6 VS1 1200Nm TN 1 3/8"z6		3831111017987
006898R	C Line 6 VS1 1500Nm TN 1 3/8"z6		3831111018960
025630R	C Line 6 ST 1700Nm TN 1 3/8" z6		3838433011075
025933R	C Line 6 ST 2000Nm TN 1 3/8" z6		3838433011297
034134R	C Line 6 ST 2400Nm TN 1 3/8" z6		3838433045841
006947R	C Line 6 ST 2700Nm TN 1 3/8"z6		3831111019448
006900R	C Line 6 TS 1200Nm TN 1 3/8"z6		3831111018984

REZERVNI DELI KARDANSKIH GREDI KARDANSKI ZGLOB 8

BR+
85 kW

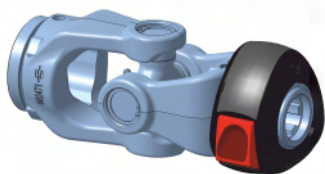

PS
85 kW

PSL
85 kW



VS1
1200 Nm

VS1
1500 Nm

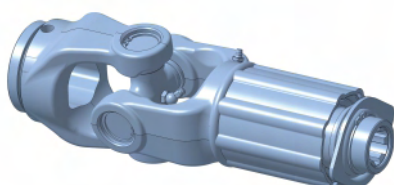

ST
3000 Nm

ST
3500 Nm

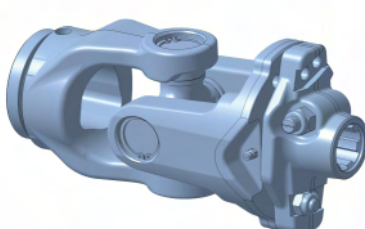

TS
1800 Nm

TS
2600 Nm

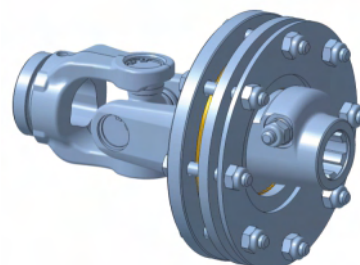

ARTIKEL OPIS

EAN 13 ČRTNA KODA

1 3/8"z6

009692R	C Line 8 BR+ TN 1 3/8"z6	BR+ 85 kW	3831111023988	
007126R	C Line 8 BR TZ 1 3/8"z6	BR 85 kW	3831111024862	
009695R	C Line 8 PS TN 1 3/8"z6	PS 85 kW	3831111024015	
009696R	C Line 8 PSL TN 1 3/8"z6	PSL 85 kW	3831111024022	
009733R	C Line 8 VS1 1200Nm TN 1 3/8"z6	VS1 1200 Nm	3831111024282	
009734R	C Line 8 VS1 1500Nm TN 1 3/8"z6	VS1 1500 Nm	3831111024299	
027189R	C line 8 ST 2400Nm TN 1 3/8"z6	ST 2400 Nm	3838433012454	
028123R	C line 8 ST 2700Nm TN 1 3/8"z6	ST 2700 Nm	3838433012874	
011724R	C Line 8 ST 3000Nm TN 1 3/8"z6	ST 3000 Nm	3831111035912	
009697R	C Line 8 ST 3500Nm TN 1 3/8"z6	ST 3500 Nm	3831111024039	
004186R	C Line 8 TS 1800Nm TN 1 3/8"z6	TS 1800 Nm	3831111035325	
010764R	C Line 8 TS 2600Nm TN 1 3/8"z6	TS 2600 Nm	3831111030825	

REZERVNI DELI KARDANSKIH GREDI

KRIŽ C Line / KPL

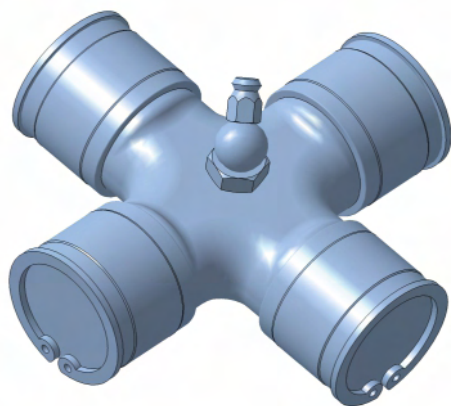

ARTIKEL	OPIS	EAN 13 ČRTNA KODA
006412R	C Line 1 22x55	3831111015273
012789R	C Line 2 23,8x61,3	3831111041739
006327R	C Line 4 27x74,6	3831111015051
006586R	C Line 6 30,2x91,4	3831111016140
009705R	C Line 8 35x106	3831111024084



REZERVNI DELI KARDANSKIH GREDI

CEVNE VILICE C Line



ARTIKEL OPIS

EAN 13 ČRTNA KODA

002643R C Line 1 TZ



3831111000873



002644R C Line 1 TN



3831111000880



012604R C Line 2 TZ



3831111041678



012668R C Line 2 TN



3831111041708



002645R C Line 4 TZ



3831111000897



002646R C Line 4 TN



3831111000903



004182R C Line 6 TZ



3831111015211



004183R C Line 6 TN



3831111015228



008095R C Line 8 TZ



3831111023650



008096R C Line 8 TN



3831111023643



REZERVNI DELI KARDANSKIH GREDI PRIKLJUČNE VILICE C Line



ARTIKEL	OPIS		EAN 13 ČRTNA KODA
002640R	C Line 1 1 3/8"z6	3831111019943	
006676R	C Line 1 1 3/8"z21	3831111016324	
007093R	C Line 1 32/38 z8	3831111020536	
012603R	C Line 2 1 3/8"z6	3831111041661	
018257R	C Line 2 1 3/8"z21	3831111097064	
018258R	C Line 2 32/38 z8	3831111097071	
004096R	C Line 4 1 3/8"z6	3831111014672	
006677R	C Line 4 1 3/8"z21	3831111017000	
007095R	C Line 4 32/38 z8	3831111020567	
004181R	C Line 6 1 3/8"z6	3831111015204	
006777R	C Line 6 1 3/8"z21	3831111017406	
007115R	C Line 6 32/38 z8	3831111020680	
008089R	C Line 6 1 3/4"z6	3831111024886	
009367R	C Line 6 1 3/4"z20	3831111024909	
008088R	C Line 8 1 3/8"z6	3831111024879	
009368R	C Line 8 1 3/8"z21	3831111024916	
009370R	C Line 8 32/38 z8	3831111024930	
008090R	C Line 8 1 3/4"z6	3831111024893	
009369R	C Line 8 1 3/4"z20	3831111024923	



REZERVNI DELI KARDANSKIH GREDI

SKLOPKA C Line PS



Omejena dobavljivost za velikosti C Line 1 in C Line 2

ARTIKEL	OPIS	EAN 13 ČRTNA KODA
007003R	C Line 1 PS 1 3/8"z6	3831111020062
009706R	C Line 1 PS 1 3/8"z21	3831111024091
009728R	C Line 1 PS 32/38 z8	3831111024237
018762R	C Line 2 PS 1 3/8"z6	3831111095619
019409R	C Line 2 PS 1 3/8"z21	3838433001373
020012R	C Line 2 PS 32/38 z8	3838433001649
007014R	C Line 4 PS 1 3/8"z6	3831111020178
009710R	C Line 4 PS 1 3/8"z21	3831111024114
009729R	C Line 4 PS 32/38 z8	3831111024244
007005R	C Line 6 PS 1 3/8"z6	3831111020086
009716R	C Line 6 PS 1 3/8"z21	3831111024138
009730R	C Line 6 PS 32/38 z8	3831111024251
009718R	C Line 8 PS 1 3/8"z6	3831111024152
009719R	C Line 8 PS 1 3/8"z21	3831111024169
009731R	C Line 8 PS 32/38 z8	3831111024268
009720R	C Line 8 PS 1 3/4"z6	3831111024176
009721R	C Line 8 PS 1 3/4"z20	3831111024183



REZERVNI DELI KARDANSKIH GREDI

SKLOPKA C Line PSL

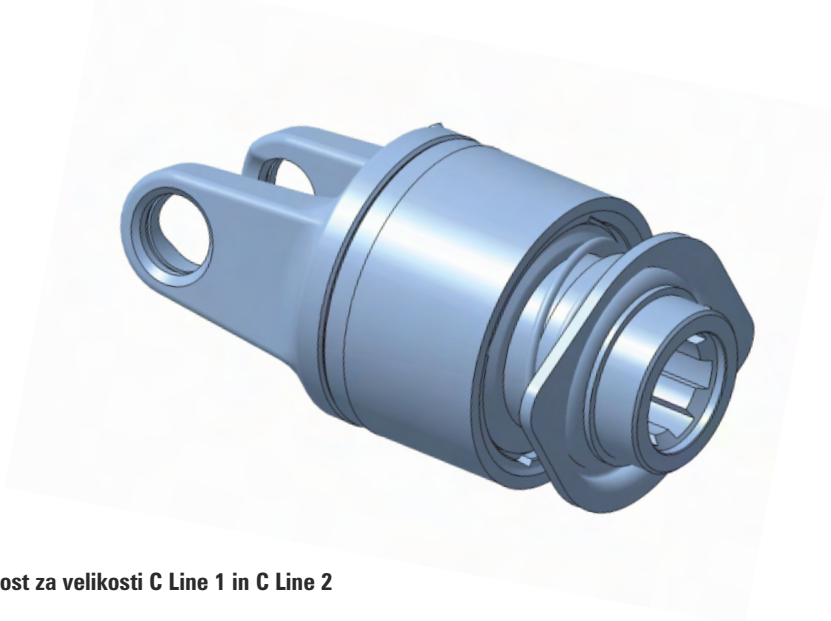

Omejena dobavljivost za velikosti C Line 1 in C Line 2

ARTIKEL	OPIS	EAN 13 ČRTNA KODA
007004R	C Line 1 PSL 1 3/8"z6	3831111020079
009709R	C Line 1 PSL 1 3/8"z21	3831111024107
020013R	C Line 1 PSL 32/38 z8	3838433001397
018765R	C Line 2 PSL 1 3/8"z6	3831111095626
020014R	C Line 2 PSL 1 3/8"z21	3838433001403
020017R	C Line 2 PSL 32/38 z8	3838433001434
007015R	C Line 4 PSL 1 3/8"z6	3831111020185
009712R	C Line 4 PSL 1 3/8"z21	3831111024121
020018R	C Line 4 PSL 32/38 z8	3838433001441
007006R	C Line 6 PSL 1 3/8"z6	3831111020093
009717R	C Line 6 PSL 1 3/8"z21	3831111024145
020019R	C Line 6 PSL 32/38 z8	3838433001458
009722R	C Line 8 PSL 1 3/8"z6	3831111024190
009723R	C Line 8 PSL 1 3/8"z21	3831111024206
009732R	C Line 8 PSL 32/38 z8	3831111024275
009724R	C Line 8 PSL 1 3/4"z6	3831111024213
009725R	C Line 8 PSL 1 3/4"z20	3831111024220

REZERVNI DELI KARDANSKIH GREDI SKLOPKA C Line VS1

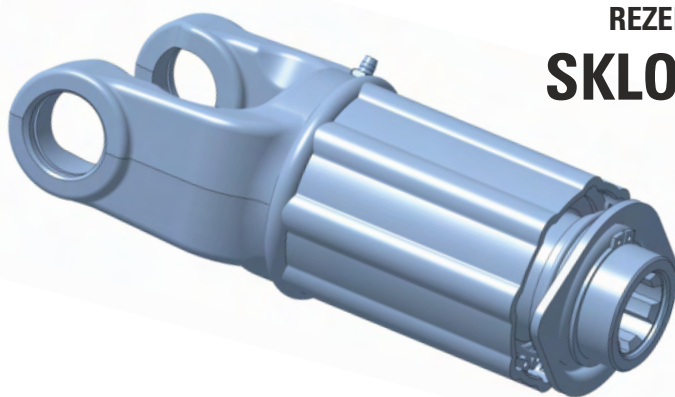

Omejena dobavljivost za velikosti C Line 1 in C Line 2

ARTIKEL	OPIS	EAN 13 ČRTNA KODA
007007R	C Line 1 VS1 300Nm 1 3/8"z6	3831111020109
020020R	C Line 1 VS1 300Nm 1 3/8"z21	3838433001465
020021R	C Line 1 VS1 300Nm 32/38 z8	3838433001472
007018R	C Line 1 VS1 450Nm 1 3/8"z6	3831111020215
020022R	C Line 1 VS1 450Nm 1 3/8"z21	3838433001489
020023R	C Line 1 VS1 450Nm 32/38 z8	3838433001496
018769R	C Line 2 VS1 450Nm 1 3/8"z6	3831111095657
020024R	C Line 2 VS1 450Nm 1 3/8"z21	3838433001502
020025R	C Line 2 VS1 450Nm 32/38 z8	3838433001519
018771R	C Line 2 VS1 600Nm 1 3/8"z6	3831111095671
020026R	C Line 2 VS1 600Nm 1 3/8"z21	3838433001526
020027R	C Line 2 VS1 600Nm 32/38 z8	3838433001533
007000R	C Line 4 VS1 600Nm 1 3/8"z6	3831111020031
020028R	C Line 4 VS1 600Nm 1 3/8"z21	3838433001540
020029R	C Line 4 VS1 600Nm 32/38 z8	3838433001557
007017R	C Line 4 VS1 900Nm 1 3/8"z6	3831111020208
020030R	C Line 4 VS1 900Nm 1 3/8"z21	3838433001564
020031R	C Line 4 VS1 900Nm 32/38 z8	3838433001571
009736R	C Line 6 VS1 900Nm 1 3/8"z6	3831111024312
020032R	C Line 6 VS1 900Nm 1 3/8"z21	3838433001588
020033R	C Line 6 VS1 900Nm 32/38 z8	3838433001595



REZERVNI DELI KARDANSKIH GREDI

SKLOPKA C Line VS1

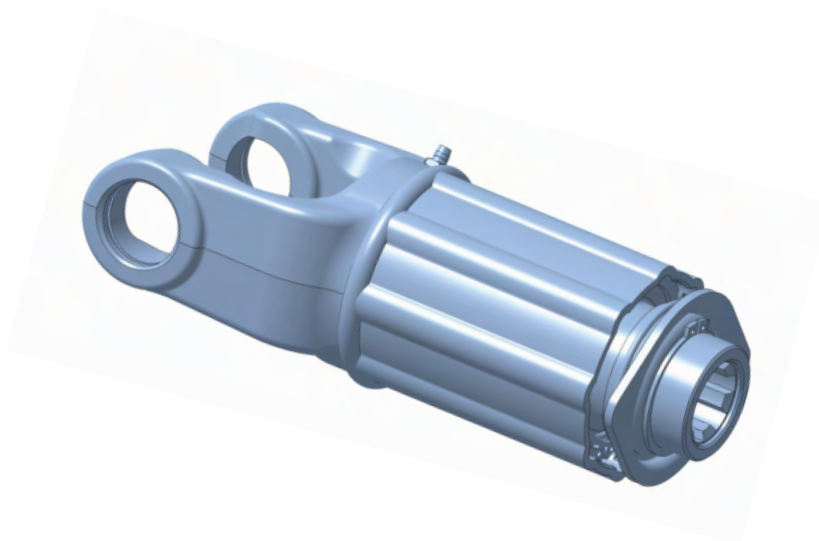

ARTIKEL	OPIS	EAN 13 ČRTNA KODA
009735R	C Line 4 VS1 1200Nm 1 3/8"z6	3831111024305
020034R	C Line 4 VS1 1200Nm 1 3/8"z21	3838433001601
020035R	C Line 4 VS1 1200Nm 32/38 z8	3838433001618
006994R	C Line 6 VS1 1200Nm 1 3/8"z6	3831111019974
020036R	C Line 6 VS1 1200Nm 1 3/8"z21	3838433001625
019990R	C Line 6 VS1 1200Nm 32/38 z8	3838433001106
007008R	C Line 6 VS1 1500Nm 1 3/8"z6	3831111020116
019662R	C Line 6 VS1 1500Nm 1 3/8"z21	3838433000369
019991R	C Line 6 VS1 1500Nm 32/38 z8	3838433001144
009693R	C Line 8 VS1 1500Nm 1 3/8"z6	3831111023995
020037R	C Line 8 VS1 1500Nm 1 3/8"z21	3838433001632
019992R	C Line 8 VS1 1500Nm 32/38 z8	3838433001151

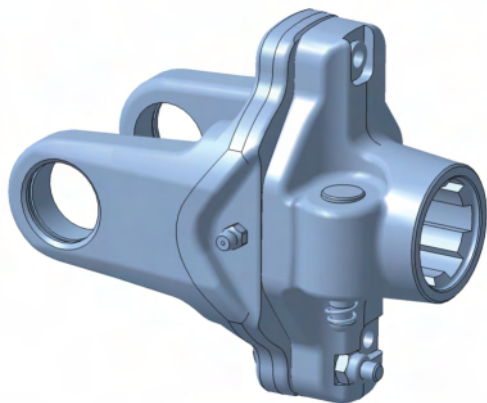

REZERVNI DELI KARDANSKIH GREDI SKLOPKA C Line ST

ARTIKEL	OPIS	EAN 13 ČRTNA KODA
007009R	C Line 4 ST 900Nm 1 3/8"z6	3831111020123
025331R	C Line 4 ST 1300Nm 1 3/8"z6	3838433047548
007010R	C Line 4 ST 1700Nm 1 3/8"z6	3831111020130
024994R	C Line 6 ST 1700Nm 1 3/8" z6	3838433011051
025288R	C Line 6 ST 1700Nm 1 3/8" z21	3838433045735
025287R	C Line 6 ST 1700Nm 1 3/4" z20	3838433011167
025290R	C Line 6 ST 2000Nm 1 3/8" z6	3838433011877
025296R	C Line 6 ST 2400Nm 1 3/8" z6	3838433045810
025302R	C Line 6 ST 2400Nm 1 3/4" z6	3838433046145
025930R	C Line 6 ST 2400Nm 1 3/4" z20	3838433011273
007011R	C Line 6 ST 2700Nm 1 3/8"z6	3831111020147
009738R	C Line 6 ST 2700Nm 1 3/4"z6	3831111024336
009740R	C Line 6 ST 2700Nm 1 3/4"z20	3831111024343
025013R	C Line 8 ST 2400Nm 1 3/8" z6	3838433012423
025312R	C Line 8 ST 2400Nm 1 3/4" z20	3838433047128
025315R	C Line 8 ST 2700Nm 1 3/8" z6	3838433047531
003035R	C Line 8 ST 3000Nm 1 3/8"z6	3831111008602
019195R	C Line 8 ST 3000Nm 1 3/8"z21	3831111097712
003036R	C Line 8 ST 3000Nm 1 3/4"z6	3831111008619
019145R	C Line 8 ST 3000Nm 1 3/4"z20	3831111097217
009741R	C Line 8 ST 3500Nm 1 3/8"z6	3831111024350
010736R	C Line 8 ST 3500Nm 1 3/8"z21	3831111030559
009742R	C Line 8 ST 3500Nm 1 3/4"z6	3831111024367
009743R	C Line 8 ST 3500Nm 1 3/4"z20	3831111024374



REZERVNI DELI KARDANSKIH GREDI

SKLOPKA C Line TS

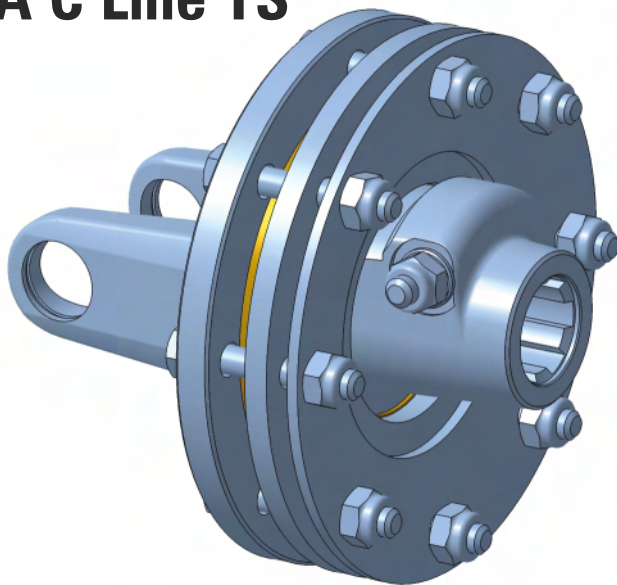

ARTIKEL	OPIS	EAN 13 ČRTNA KODA
007012R	C Line 4 TS 800Nm 1 3/8"z6	3831111020154
007104R	C Line 6 TS 900Nm 1 3/8"z6	3831111020628
007013R	C Line 6 TS 1200Nm 1 3/8"z6	3831111020161
008980R	C Line 6 TS 1200Nm 1 3/4"z6	3831111023032
018997R	C Line 6 TS 1450Nm 1 3/4"z6	3831111096883
003054R	C Line 8 TS 1800Nm 1 3/8"z6	3831111008626
003055R	C Line 8 TS 1800Nm 1 3/4"z6	3831111008671
019244R	C Line 8 TS 1800Nm 1 3/4"z20	3831111098207
009744R	C Line 8 TS 2000Nm 1 3/8"z6	3831111024381
010746R	C Line 8 TS 2000Nm 1 3/8"z21	3831111030641
009745R	C Line 8 TS 2000Nm 1 3/4"z6	3831111024398
010747R	C Line 8 TS 2000Nm 1 3/4"z20	3831111030658
019003R	C Line 8 TS 2500Nm 1 3/4"z6	3831111096944
010760R	C Line 8 TS 2600Nm 1 3/8"z6	3831111030788
010761R	C Line 8 TS 2600Nm 1 3/8"z21	3831111030795
010762R	C Line 8 TS 2600Nm 1 3/4"z6	3831111030801
010763R	C Line 8 TS 2600Nm 1 3/4"z20	3831111030818

REZERVNI DELI KARDANSKIH GREDI
KOVINSKA CEV C Line 1 / KPL

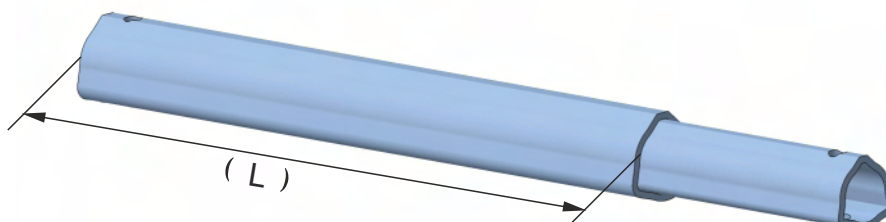

ARTIKEL	OPIS		EAN 13 ČRTNA KODA
006448R	1 kpl za kk510 (395)	3831111018199	
006451R	1 kpl za kk560 (445)	3831111018205	
006452R	1 kpl za kk610 (495)	3831111018212	
006453R	1 kpl za kk660 (545)	3831111018229	
006454R	1 kpl za kk710 (595)	3831111018236	
006533R	1 kpl za kk760 (645)	3831111018243	
006534R	1 kpl za kk810 (695)	3831111018250	
006535R	1 kpl za kk860 (745)	3831111018267	
006413R	1 kpl za kk910 (795)	3831111018182	
006537R	1 kpl za kk960 (845)	3831111018274	
006539R	1 kpl za kk1010 (895)	3831111018281	
006541R	1 kpl za kk1110 (995)	3831111018298	
006543R	1 kpl za kk1210 (1095)	3831111018304	
006545R	1 kpl za kk1310 (1195)	3831111018311	
006547R	1 kpl za kk1410 (1295)	3831111018328	

REZERVNI DELI KARDANSKIH GREDI

KOVINSKA CEV C Line 2 / KPL

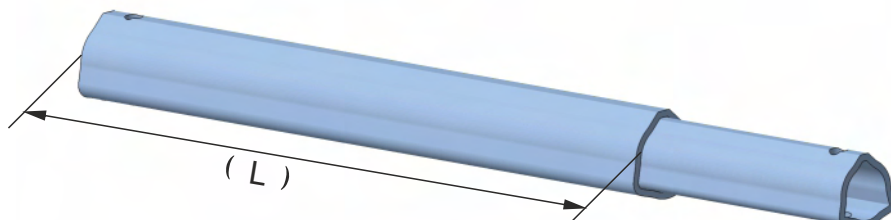

ARTIKEL	OPIS	EAN 13 ČRTNA KODA
018859R	2 kpl za kk510 (385)	3831111095770
018474R	2 kpl za kk560 (435)	3831111094872
018860R	2 kpl za kk610 (485)	3831111095787
018663R	2 kpl za kk660 (535)	3831111095374
018861R	2 kpl za kk710 (585)	3831111095794
018862R	2 kpl za kk760 (635)	3831111095800
018863R	2 kpl za kk810 (685)	3831111095817
018864R	2 kpl za kk860 (735)	3831111095824
012790R	2 kpl za kk910 (785)	3831111041746
018865R	2 kpl za kk960 (835)	3831111095831
018866R	2 kpl za kk1010 (885)	3831111095848
018868R	2 kpl za kk1110 (985)	3831111095855
018869R	2 kpl za kk1210 (1085)	3831111095862
018871R	2 kpl za kk1310 (1185)	3831111095879
018872R	2 kpl za kk1410 (1285)	3831111095886

REZERVNI DELI KARDANSKIH GREDI
KOVINSKA CEV C Line 4 / KPL

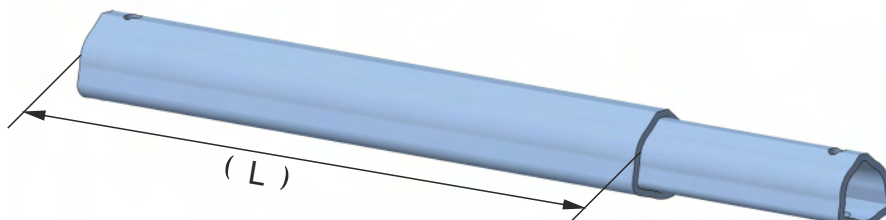

ARTIKEL	OPIS		EAN 13 ČRTNA KODA
006584R	4 kpl za kk510 (370)	3831111018335	
006587R	4 kpl za kk560 (420)	3831111018342	
006588R	4 kpl za kk610 (470)	3831111018359	
006589R	4 kpl za kk660 (520)	3831111018366	
006590R	4 kpl za kk710 (570)	3831111018373	
006591R	4 kpl za kk760 (620)	3831111018380	
006593R	4 kpl za kk810 (670)	3831111018397	
006594R	4 kpl za kk860 (720)	3831111018403	
006105R	4 kpl za kk910 (770)	3831111018175	
006595R	4 kpl za kk960 (820)	3831111018410	
006596R	4 kpl za kk1010 (870)	3831111018427	
006597R	4 kpl za kk1110 (970)	3831111018434	
006598R	4 kpl za kk1210 (1070)	3831111018441	
006599R	4 kpl za kk1310 (1170)	3831111018458	
006600R	4 kpl za kk1410 (1270)	3831111018465	

REZERVNI DELI KARDANSKIH GREDI

KOVINSKA CEV C Line 6 / KPL

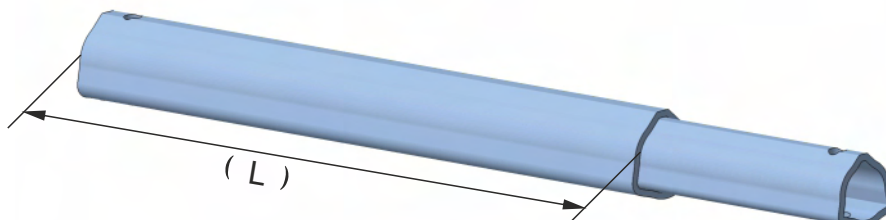

ARTIKEL	OPIS	EAN 13 ČRTNA KODA
006627R	6 kpl za kk560 (385)	3831111018472
006628R	6 kpl za kk610 (435)	3831111018489
006629R	6 kpl za kk660 (485)	3831111018496
006630R	6 kpl za kk710 (535)	3831111018502
006631R	6 kpl za kk760 (585)	3831111018519
006632R	6 kpl za kk810 (635)	3831111018526
006633R	6 kpl za kk860 (685)	3831111018533
006634R	6 kpl za kk910 (735)	3831111018540
006635R	6 kpl za kk960 (785)	3831111018557
006636R	6 kpl za kk1010 (835)	3831111018564
006637R	6 kpl za kk1110 (935)	3831111018571
006638R	6 kpl za kk1210 (1035)	3831111018588
006639R	6 kpl za kk1310 (1135)	3831111018595
006640R	6 kpl za kk1410 (1235)	3831111018601

REZERVNI DELI KARDANSKIH GREDI
KOVINSKA CEV C Line 8 / KPL

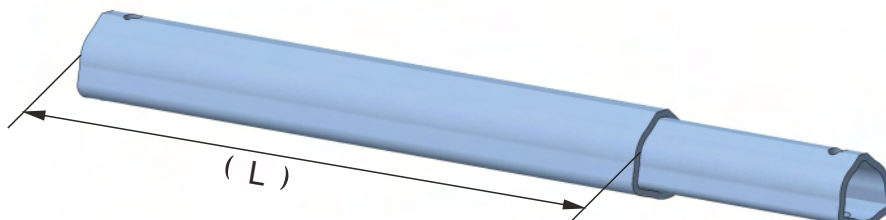

ARTIKEL	OPIS		EAN 13 ČRTNA KODA
009752R	8 kpl za kk560 (360)	3831111024459	
009753R	8 kpl za kk610 (410)	3831111024466	
009754R	8 kpl za kk660 (460)	3831111024473	
009755R	8 kpl za kk710 (510)	3831111024480	
009756R	8 kpl za kk760 (560)	3831111024497	
009757R	8 kpl za kk810 (610)	3831111024503	
009758R	8 kpl za kk860 (660)	3831111024510	
009759R	8 kpl za kk910 (710)	3831111024527	
009760R	8 kpl za kk960 (760)	3831111024534	
009761R	8 kpl za kk1010 (810)	3831111024541	
009762R	8 kpl za kk1110 (910)	3831111024558	
009763R	8 kpl za kk1210 (1010)	3831111024565	
009764R	8 kpl za kk1310 (1110)	3831111024572	
009766R	8 kpl za kk1410 (1210)	3831111024596	

REZERVNI DELI KARDANSKIH GREDI

OKROV C Line, VARNOSTNI ZATIČ C Line



ARTIKEL	OPIS	EAN 13 ČRTNA KODA
006411R	C Line 1	3831111015266
008982R	C Line 1 32/38 z8	3831111023056
018561R	C Line 2	3831111095152
018477R	C Line 2 32/38 z8	3831111094896
006103R	C Line 4	3831111015068
007502R	C Line 4 32/38 z8	3831111022127
006585R	C Line 6	3831111016133
009750R	C Line 6 32/38 z8	3831111024435
008455R	C Line 6 1 3/4"	3831111025029
008452R	C Line 8	3831111025012
009751R	C Line 8 32/38 z8	3831111024442
008456R	C Line 8 1 3/4"	3831111025036

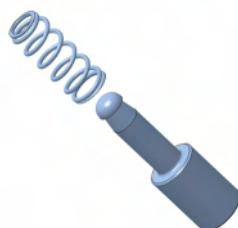

002677R	Varnostni zatič C Line 1;2;4;6 1 3/8"z6 10 Pcs	3831111001153
009554R	Varnostni zatič C Line 6;8 1 3/4" 10 Pcs	3831111023841
011720R	Varnostni zatič C Line 8 1 3/8"z6 10 Pcs	3831111035882
011721R	Varnostni zatič C Line 8 1 3/8"z21 10 Pcs	3831111035899

REZERVNI DELI KARDANSKIH GREDI ZAŠČITA C Line 1 / KPL



ARTIKEL	OPIS		EAN 13 ČRTNA KODA
006505R	C Line 1 za kk510 (300)	3831111015716	
006506R	C Line 1 za kk560 (350)	3831111015723	
006507R	C Line 1 za kk610 (400)	3831111015730	
006508R	C Line 1 za kk660 (450)	3831111015747	
006509R	C Line 1 za kk710 (500)	3831111015754	
006510R	C Line 1 za kk760 (550)	3831111015761	
006511R	C Line 1 za kk810 (600)	3831111015778	
006512R	C Line 1 za kk860 (650)	3831111015785	
006414R	C Line 1 za kk910 (700)	3831111015280	
006513R	C Line 1 za kk960 (750)	3831111015792	
006514R	C Line 1 za kk1010 (800)	3831111015808	
006515R	C Line 1 za kk1110 (900)	3831111015815	
006516R	C Line 1 za kk1210 (1000)	3831111015822	
006517R	C Line 1 za kk1310 (1100)	3831111015839	
006518R	C Line 1 za kk1410 (1200)	3831111015846	

REZERVNI DELI KARDANSKIH GREDI ZAŠČITA C Line 2 / KPL



ARTIKEL	OPIS	EAN 13 ČRTNA KODA
018886R	C Line 2 za kk510 (290)	3831111096012
018472R	C Line 2 za kk560 (340)	3831111094865
018887R	C Line 2 za kk610 (390)	3831111096029
018888R	C Line 2 za kk660 (440)	3831111096036
018744R	C Line 2 za kk710 (490)	3831111095541
018889R	C Line 2 za kk760 (540)	3831111096043
018891R	C Line 2 za kk810 (590)	3831111096050
018892R	C Line 2 za kk860 (640)	3831111095749
012792R	C Line 2 za kk910 (690)	3831111041760
018893R	C Line 2 za kk960 (740)	3831111096074
018894R	C Line 2 za kk1010 (790)	3831111096081
018895R	C Line 2 za kk1110 (890)	3831111096098
018896R	C Line 2 za kk1210 (990)	3831111096104
018897R	C Line 2 za kk1310 (1090)	3831111096111
018898R	C Line 2 za kk1410 (1190)	3831111096128

REZERVNI DELI KARDANSKIH GREDI ZAŠČITA C Line 4 / KPL



ARTIKEL	OPIS		EAN 13 ČRTNA KODA
006519R	C Line 4 za kk510 (270)	3831111015853	
006520R	C Line 4 za kk560 (320)	3831111015860	
006521R	C Line 4 za kk610 (370)	3831111015877	
006522R	C Line 4 za kk660 (420)	3831111015884	
006523R	C Line 4 za kk710 (470)	3831111015891	
006524R	C Line 4 za kk760 (520)	3831111015907	
006525R	C Line 4 za kk810 (570)	3831111015914	
006526R	C Line 4 za kk860 (620)	3831111015921	
006104R	C Line 4 za kk910 (670)	3831111015044	
006527R	C Line 4 za kk960 (720)	3831111015938	
006528R	C Line 4 za kk1010 (770)	3831111015945	
006529R	C Line 4 za kk1110 (870)	3831111015952	
006530R	C Line 4 za kk1210 (970)	3831111015969	
006531R	C Line 4 za kk1310 (1070)	3831111015976	
006532R	C Line 4 za kk1410 (1170)	3831111015983	

REZERVNI DELI KARDANSKIH GREDI ZAŠČITA C Line 6 / KPL



ARTIKEL	OPIS		EAN 13 ČRTNA KODA
006538R	C Line 6 za kk560 (280)	3831111015990	
006540R	C Line 6 za kk610 (330)	3831111016003	
006542R	C Line 6 za kk660 (380)	3831111016010	
006544R	C Line 6 za kk710 (430)	3831111016027	
006546R	C Line 6 za kk760 (480)	3831111016034	
006548R	C Line 6 za kk810 (530)	3831111016041	
006549R	C Line 6 za kk860 (580)	3831111016058	
006550R	C Line 6 za kk910 (630)	3831111016065	
006551R	C Line 6 za kk960 (680)	3831111016072	
006552R	C Line 6 za kk1010 (730)	3831111016089	
006553R	C Line 6 za kk1110 (830)	3831111016096	
006554R	C Line 6 za kk1210 (930)	3831111016102	
006555R	C Line 6 za kk1310 (1030)	3831111016119	
006556R	C Line 6 za kk1410 (1130)	3831111016126	

REZERVNI DELI KARDANSKIH GREDI ZAŠČITA C Line 8 / KPL



ARTIKEL	OPIS	EAN 13 ČRTNA KODA
009778R	C Line 8 za kk560 (240)	3831111024602
009779R	C Line 8 za kk610 (290)	3831111024619
009780R	C Line 8 za kk660 (340)	3831111024626
009781R	C Line 8 za kk710 (390)	3831111024633
009782R	C Line 8 za kk760 (440)	3831111024640
009783R	C Line 8 za kk810 (490)	3831111024657
009784R	C Line 8 za kk860 (540)	3831111024664
009787R	C Line 8 za kk910 (590)	3831111024688
009788R	C Line 8 za kk960 (640)	3831111024695
009789R	C Line 8 za kk1010 (690)	3831111024701
009790R	C Line 8 za kk1110 (790)	3831111024718
009791R	C Line 8 za kk1210 (890)	3831111024725
009792R	C Line 8 za kk1310 (990)	3831111024732
009793R	C Line 8 za kk1410 (1090)	3831111024749

REZERVNI DELI KARDANSKIH GREDI

DELI ZAŠČITE



ARTIKEL	OPIS
004226R	C Line 1
018560R	C Line 2
003298R	C Line 4
004190R	C Line 6
008730R	C Line 8

EAN 13 ČRTNA KODA
3831111020260
3831111095145
3831111020239
3831111020246
3831111023964



ARTIKEL	OPIS
004224R	C Line 1
018562R	C Line 2
003303R	C Line 4
004225R	C Line 6
008727R	C Line 8

EAN 13 ČRTNA KODA
3831111020253
3831111095169
3831111015198
3831111015235
3831111023957



ARTIKEL	OPIS
006097R	Tip C Line

EAN 13 ČRTNA KODA
3831111020277

REZERVNI DELI KARDANSKIH GREDI
CEV Z OHIŠJEM C Line 1

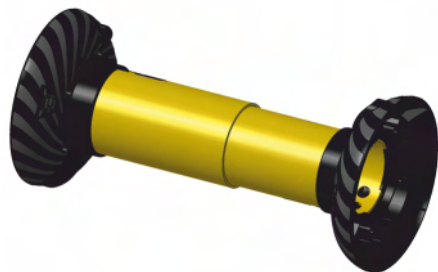

ARTIKEL	OPIS	EAN 13 ČRTNA KODA
006328R	C Line 1 za kk510 (300)	3831111015242
006409R	C Line 1 za kk910 (700)	3831111015259
006415R	C Line 1 za kk560 (350)	3831111015297
006455R	C Line 1 za kk610 (400)	3831111015310
006456R	C Line 1 za kk660 (450)	3831111015327
006457R	C Line 1 za kk710 (500)	3831111015334
006458R	C Line 1 za kk760 (550)	3831111015341
006459R	C Line 1 za kk810 (600)	3831111015358
006460R	C Line 1 za kk860 (650)	3831111015365
006461R	C Line 1 za kk960 (750)	3831111015372
006462R	C Line 1 za kk1010 (800)	3831111015389
006463R	C Line 1 za kk1110 (900)	3831111015396
006464R	C Line 1 za kk1210 (1000)	3831111015402
006465R	C Line 1 za kk1310 (1100)	3831111015419
006466R	C Line 1 za kk1410 (1200)	3831111015426

REZERVNI DELI KARDANSKIH GREDI

CEV Z OHIŠJEM C Line 2

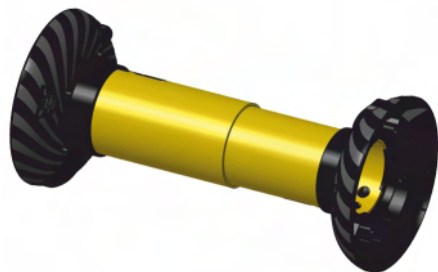

ARTIKEL	OPIS	EAN 13 ČRTNA KODA
018873R	C Line 2 za kk510 (290)	3831111095893
018470R	C Line 2 za kk560 (340)	3831111094841
018874R	C Line 2 za kk610 (390)	3831111095909
018875R	C Line 2 za kk660 (440)	3831111095916
018743R	C Line 2 za kk710 (490)	3831111095534
018876R	C Line 2 za kk760 (540)	3831111095923
018877R	C Line 2 za kk810 (590)	3831111095930
018878R	C Line 2 za kk860 (640)	3831111095947
012754R	C Line 2 za kk910 (690)	3831111041715
018879R	C Line 2 za kk960 (740)	3831111095954
018880R	C Line 2 za kk1010 (790)	3831111095961
018881R	C Line 2 za kk1110 (890)	3831111095978
018882R	C Line 2 za kk1210 (990)	3831111095985
018883R	C Line 2 za kk1310 (1090)	3831111095992
018884R	C Line 2 za kk1410 (1190)	3831111096005

REZERVNI DELI KARDANSKIH GREDI CEV Z OHIŠJEM C Line 4



ARTIKEL	OPIS		EAN 13 ČRTNA KODA
006472R	C Line 4 za kk510 (270)	3831111015433	
006473R	C Line 4 za kk560 (320)	3831111015440	
006474R	C Line 4 za kk610 (370)	3831111015457	
006475R	C Line 4 za kk660 (420)	3831111015464	
006476R	C Line 4 za kk710 (470)	3831111015471	
006477R	C Line 4 za kk760 (520)	3831111015488	
006478R	C Line 4 za kk810 (570)	3831111015495	
006479R	C Line 4 za kk860 (620)	3831111015501	
006099R	C Line 4 za kk910 (670)	3831111015037	
006480R	C Line 4 za kk960 (720)	3831111015518	
006481R	C Line 4 za kk1010 (770)	3831111015525	
006482R	C Line 4 za kk1110 (870)	3831111015532	
006483R	C Line 4 za kk1210 (970)	3831111015549	
006484R	C Line 4 za kk1310 (1070)	3831111015556	
006485R	C Line 4 za kk1410 (1170)	3831111015563	

REZERVNI DELI KARDANSKIH GREDI

CEV Z OHIŠJEM C Line 6



ARTIKEL	OPIS	EAN 13 ČRTNA KODA
006491R	C Line 6 za kk560 (280)	3831111015570
006492R	C Line 6 za kk610 (330)	3831111015587
006493R	C Line 6 za kk660 (380)	3831111015594
006494R	C Line 6 za kk710 (430)	3831111015600
006495R	C Line 6 za kk760 (480)	3831111015617
006496R	C Line 6 za kk810 (530)	3831111015624
006497R	C Line 6 za kk860 (580)	3831111015631
006498R	C Line 6 za kk910 (630)	3831111015648
006499R	C Line 6 za kk960 (680)	3831111015655
006500R	C Line 6 za kk1010 (730)	3831111015662
006501R	C Line 6 za kk1110 (830)	3831111015679
006502R	C Line 6 za kk1210 (930)	3831111015686
006503R	C Line 6 za kk1310 (1030)	3831111015693
006504R	C Line 6 za kk1410 (1130)	3831111015709

REZERVNI DELI KARDANSKIH GREDI
CEV Z OHIŠJEM C Line 8

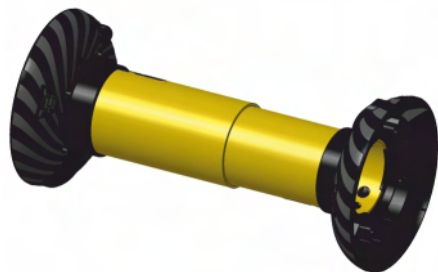

ARTIKEL	OPIS	EAN 13 ČRTNA KODA
009795R	C Line 8 za kk510 (190)	3831111024756
009796R	C Line 8 za kk560 (240)	3831111024763
009797R	C Line 8 za kk610 (290)	3831111024770
009798R	C Line 8 za kk660 (340)	3831111024787
009799R	C Line 8 za kk710 (390)	3831111024794
009800R	C Line 8 za kk760 (440)	3831111024800
009801R	C Line 8 za kk810 (490)	3831111024817
009802R	C Line 8 za kk860 (540)	3831111024824
008733R	C Line 8 za kk910 (590)	3831111023971
009803R	C Line 8 za kk960 (640)	3831111024831
009804R	C Line 8 za kk1010 (690)	3831111024848
009805R	C Line 8 za kk1110 (790)	3831111024855
009806R	C Line 8 za kk1210 (890)	3831111023902
009807R	C Line 8 za kk1310 (990)	3831111023919
009808R	C Line 8 za kk1410 (1090)	3831111023926

REZERVNI DELI KARDANSKIH GREDI



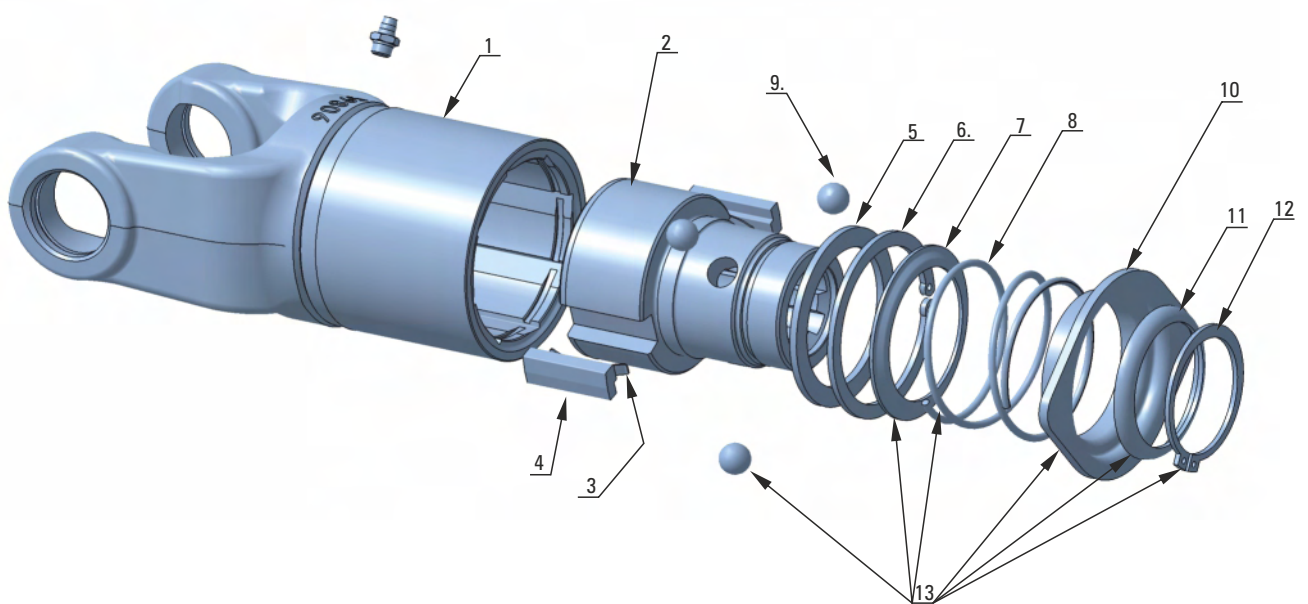































DELI SKLOPKE C Line PS / PSL



REZERVNI DELI KARDANSKIH GREDI

DELI SKLOPKE C Line PS / PSL

Omejena dobavljivost za velikosti C Line 1 in C Line 2

KOMPONENTE	ARTIKEL	OPIS			EAN 13 ČRTNA KODA		
1	006289R	Ohišje sklopke C Line 1 PS			3831111014696		
1	006290R	Ohišje sklopke C Line 1 PSL			3831111014702		
1	020008R	Ohišje sklopke C Line 2 PS			3838433001311		
1	020009R	Ohišje sklopke C Line 2 PSL			3838433001328		
1	006291R	Ohišje sklopke C Line 4 PS			3831111014719		
1	006292R	Ohišje sklopke C Line 4 PSL			3831111014726		
1	006293R	Ohišje sklopke C Line 6 PS			3831111014733		
1	006294R	Ohišje sklopke C Line 6 PSL			3831111014740		
2	006295R	Jedro C Line PS 1 3/8"z6				3831111014757	
2	006296R	Jedro C Line PS 1 3/8"z21				3831111014764	
2	011538R	Jedro C Line PS 32/38 z8				3838433001120	
3	006297R	Vzmet listnata C Line PS				3831111014771	
4	006298R	Zob C Line PS				3831111014788	
5	006299R	Distančnik C Line PS				3831111014795	
6	006300R	Vskočnik C Line PS				3831111014801	
7	006301R	Obroč zaščitni C Line PS				3831111014818	
8	007001R	Vzmet potisna C Line				3831111020048	
8	011539R	Vzmet potisna C Line 32/38 z8				3838433001366	
9	006996R	Kroglica C Line				3831111019998	
10	006999R	Plošča snemalna C Line				3831111020024	
10	004129R	Plošča snemalna C Line 32/38 z8				3838433001342	
11	006997R	Obroč kotni C Line				3831111020000	
11	004134R	Obroč kotni C Line 32/38 z8				3838433001359	
12	006306R	Vskočnik C Line				3831111014863	
13	006995R	Priključni mehanizem C Line				3831111019981	
14	020067R	Priključni mehanizem C Line 32/38 z8				3838433001731	



DELI SKLOPKE C Line VS

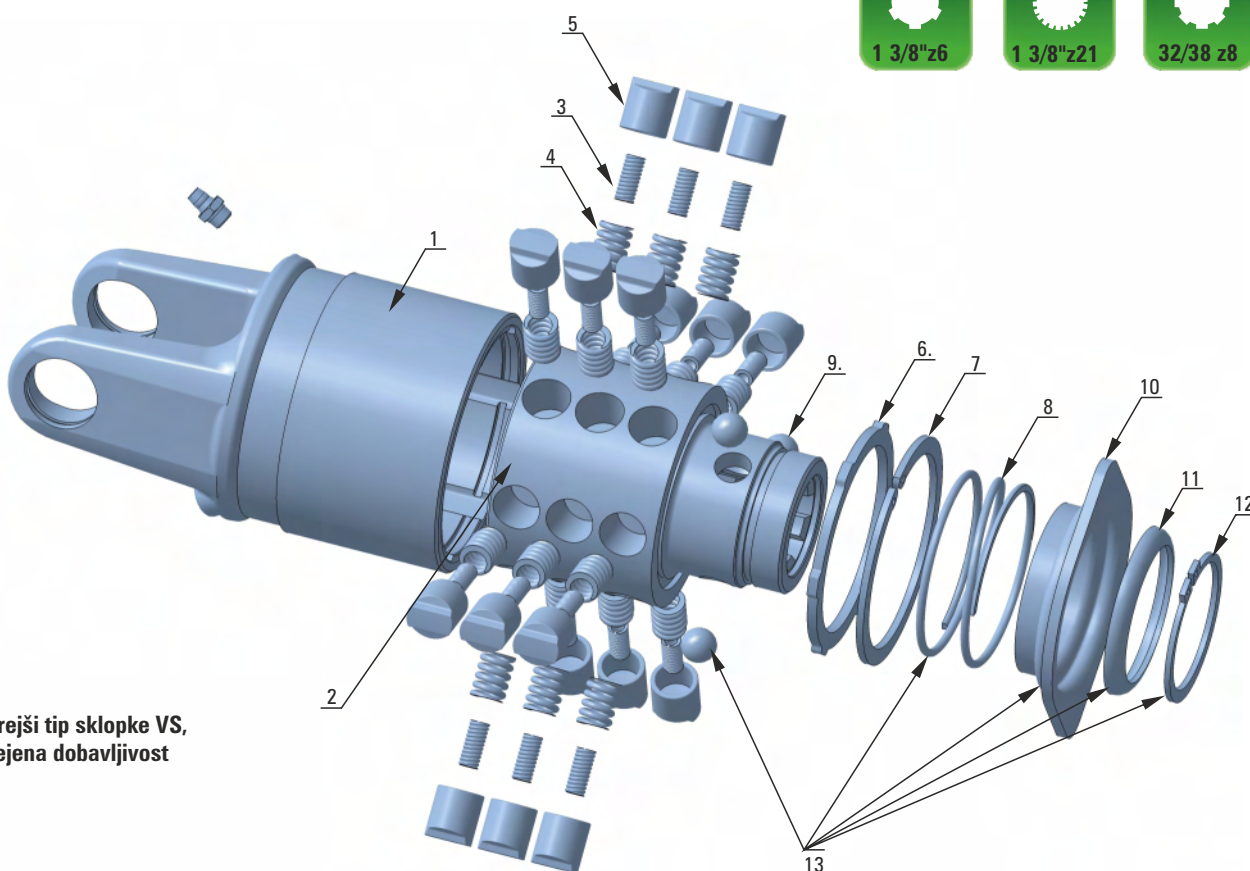

Starejši tip sklopke VS,
omejena dobavljivost

KOMPONENTE

ARTIKEL	OPIS		EAN 13 ČRTNA KODA
1 006307R	Ohišje sklopke C Line 1 VS 360Nm	 	3831111014870 
1 020010R	Ohišje sklopke C line 2 VS 720Nm	 	3838433001335 
1 006308R	Ohišje sklopke C Line 4 VS 720Nm	 	3831111014887 
1 006309R	Ohišje sklopke C Line 4 VS 1080Nm	 	3831111014894 
1 006310R	Ohišje sklopke C Line 4 VS 1440Nm	 	3831111014900 

REZERVNI DELI KARDANSKIH GREDI

DELI SKLOPKE C Line VS

KOMPONENTE

ARTIKEL	OPIS		EAN 13 ČRTNA KODA
2 006311R	Jedro C Line VS 360Nm 1 3/8"z6		3831111014917 
2 020048R	Jedro C Line VS 360Nm 1 3/8"z21		3838433001663 
2 020050R	Jedro C Line VS 360Nm 32/38 z8		3838433001687 
2 006312R	Jedro C Line VS 720Nm 1 3/8"z6		3831111014924 
2 006313R	Jedro C Line VS 720Nm 1 3/8"z21		3831111014931 
2 020051R	Jedro C Line VS 720Nm 32/38 z8		3838433001694 
2 006314R	Jedro C Line VS 1080Nm 1 3/8"z6		3831111014948 
2 020049R	Jedro C Line VS 1080Nm 1 3/8"z21		3838433001670 
2 020052R	Jedro C Line VS 1080Nm 32/38 z8		3838433001700 
3 006315R	Vzmet notranja C Line VS		3831111014955 
4 006316R	Vzmet zunanja C Line VS		3831111014962 
5 006317R	Zob C Line VS		3831111014979 
6 006318R	Obroč zapirni C Line VS		3831111014986 
7 006319R	Vskočnik C Line VS		3831111014993 
8 007001R	Vzmet potisna C Line		3831111020048 
8 011539R	Vzmet potisna C Line 32x38 z8		3838433001366 
9 006996R	Kroglica C Line		3831111019998 
10 006999R	Plošča snemalna C Line		3831111020024 
10 004129R	Plošča snemalna C Line 32x38 z8		3838433001342 
11 006997R	Obroč kotni C Line		3831111020000 
11 004134R	Obroč kotni C Line 32x38 z8		3838433001359 
12 006306R	Vskočnik C Line		3831111014863 
13 006995R	Priključni mehanizem C Line		3831111019981 
13 020053R	Priključni mehanizem C Line VS 32x38 z8		3838433001717 



REZERVNI DELI KARDANSKIH GREDI

DELI SKLOPKE C Line VS1

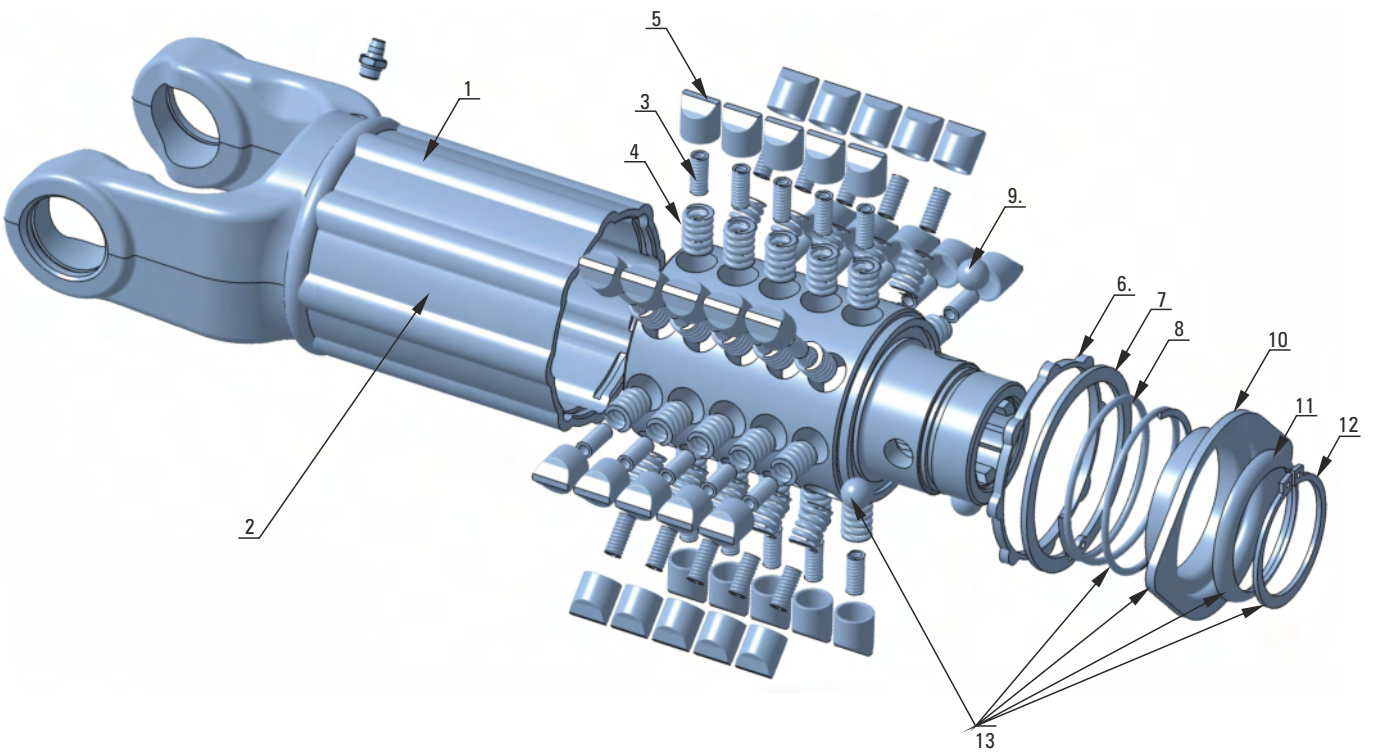

REZERVNI DELI KARDANSKIH GREDI

DELI SKLOPKE C Line VS1

KOMPONENTE

ARTIKEL	OPIS			EAN 13 ČRTNA KODA	
1	007322R	Ohišje sklopke C Line 4 VS1 1200Nm		3838433001656	
1	006998R	Ohišje sklopke C Line 6 VS1 1200Nm		3831111020017	
1	007019R	Ohišje sklopke C Line 6 VS1 1500Nm		3831111020222	
1	019099R	Ohišje sklopke C Line 8 VS1 1500Nm		3838433000956	
2	007002R	Jedro C Line VS1 1200Nm 1 3/8"z6		3831111020055	
2	020011R	Jedro C Line VS1 1200Nm 1 3/8"z21		3838433001380	
2	019982R	Jedro C Line VS1 1200Nm 32/38 z8		3838433001021	
2	007016R	Jedro C Line VS1 1500Nm 1 3/8"z6		3831111020192	
2	019663R	Jedro C Line VS1 1500Nm 1 3/8"z21		3838433000963	
2	019983R	Jedro C Line VS1 1500Nm 32/38 z8		3838433001038	
3	006315R	Vzmet notranja C Line VS		3831111014955	
4	006316R	Vzmet zunanja C Line VS		3831111014962	
5	007042R	Zob C Line VS1		3831111020451	
6	007306R	Obroč zapirni C Line VS1		3831111097101	
7	006319R	Vskočnik C Line VS		3831111014993	
8	007001R	Vzmet potisna C Line VS		3831111020048	
8	011539R	Vzmet potisna C Line 32x38 z8		3838433001366	
9	006996R	Kroglica C Line		3831111019998	
10	006999R	Plošča snemalna C Line		3831111020024	
10	004129R	Plošča snemalna C Line 32x38 z8		3838433001342	
11	006997R	Obroč kotni C Line		3831111020000	
11	004134R	Obroč kotni C Line 32x38 z8		3838433001359	
12	006306R	Vskočnik C Line		3831111014863	
13	020015R	Priključni mehanizem C Line VS1		3838433001410	
13	020016R	Priključni mehanizem C Line VS1 32x38 z8		3838433001427	



REZERVNI DELI KARDANSKIH GREDI

DELI SKLOPKE C Line ST

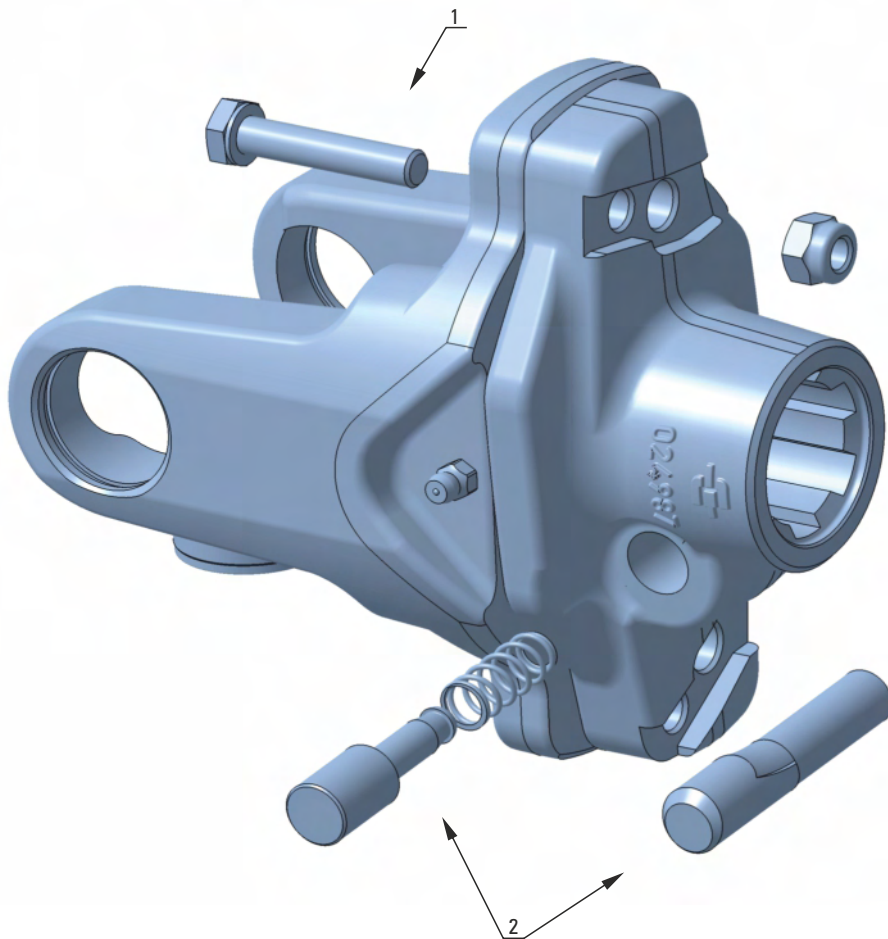

1 3/8"z6



1 3/8"z21



1 3/4"z6



1 3/8"z20

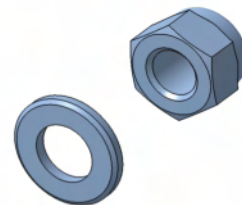

KOMPONENTE

ARTIKEL OPIS

1	007020R	Vijak strižni C Line ST M6x40, 8.8	
1	007021R	Vijak strižni C Line ST M8x45, 8.8	
1	007022R	Vijak strižni C Line ST M10x50, 8.8	
1	039756R	Vijak strižni C Line ST M12x50, 8.8	
2	003907R	Varnostni zatič 1 3/4"z6-z20	
2	004125R	Vijak varnostni 1 3/8" ; 32/38 z8	

EAN 13 ČRTNA KODA

3831111020307



3831111020314



3831111020321



3838433047562



3831111008763



3838433045872



REZERVNI DELI KARDANSKIH GREDI DELI SKLOPKE C Line TS

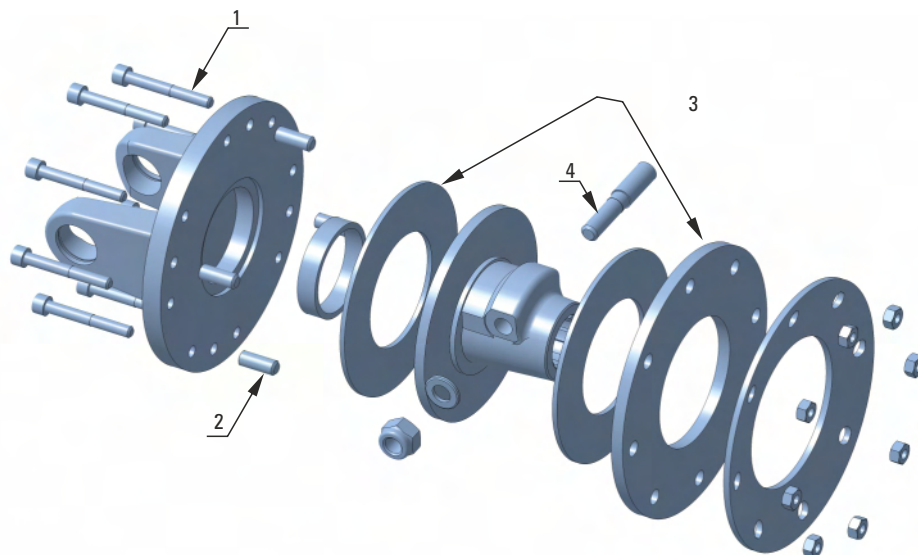

1 3/8"z6



1 3/8"z21



1 3/4"z6



1 3/8"z20

KOMPONENTE

ARTIKEL OPIS

ARTIKEL	KOMPONENTE	OPIS
007031R	1	Vijak sklopke C Line TS M10x55
007033R	1	Vijak sklopke C Line TS M10x75
007037R	2	Vijak razbremenilni C Line TS M10x25
007038R	2	Vijak razbremenilni C Line TS M10x40
004125R	2	Vijak varnostni 1 3/8" ; 32/38 z8
007040R	3	Lamela C Line TS, D141 d77
003907R	4	Vijak varnostni 1 3/4"z6-z20

EAN 13 ČRTNA KODA

EAN 13 ČRTNA KODA	Barcode
3831111020345	
3831111020369	
3831111020406	
3831111020413	
3838433045872	
3831111020437	
3831111008763	





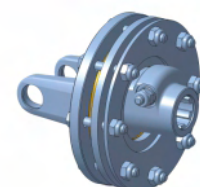
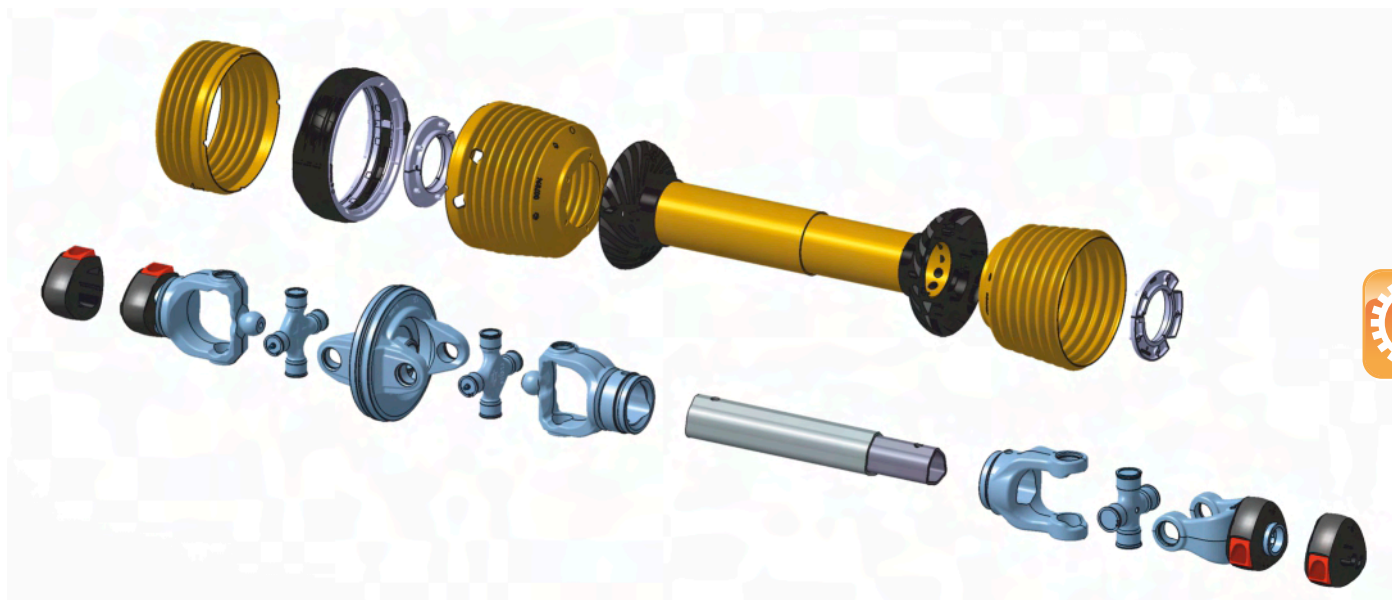

REZERVNI DELI ŠIROKOKOTNE KARDANSKE GREDI

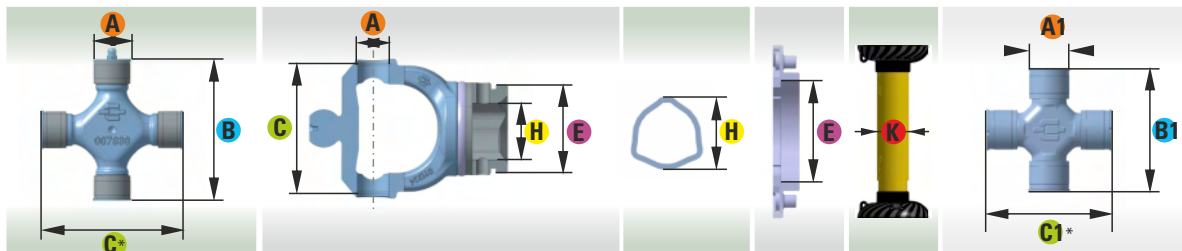

REZERVNI DELI

DIMENZIJSKE LASTNOSTI ŠIROKOKOTNIH KARDANSKIH GREDI



	A	B	C*	A	C	E	H	H	E	K	A1	B1	C1*
  30 kW / 40 HP	23,8	88	90,4*	23,8	90,4	61	43,5/36,5	43,5/36,5	61	67/61,5	27	74,6	77*
 52 kW / 70 HP	27	102	104,4*	27	104,4	76	53,5/45,5	53,5/45,5	76	82/76	30,2	91,4	94,4*
 85 kW / 115 HP	30,2	122	125*	30,2	125	83,8	62,6/53,6	62,6/53,6	83,8	92/86	34,9	106	109,45*

*mera z vskočnikom

REZERVNI DELI ŠIROKOKOTNIH KARDANSKIH GREDI C Line 4 DZ

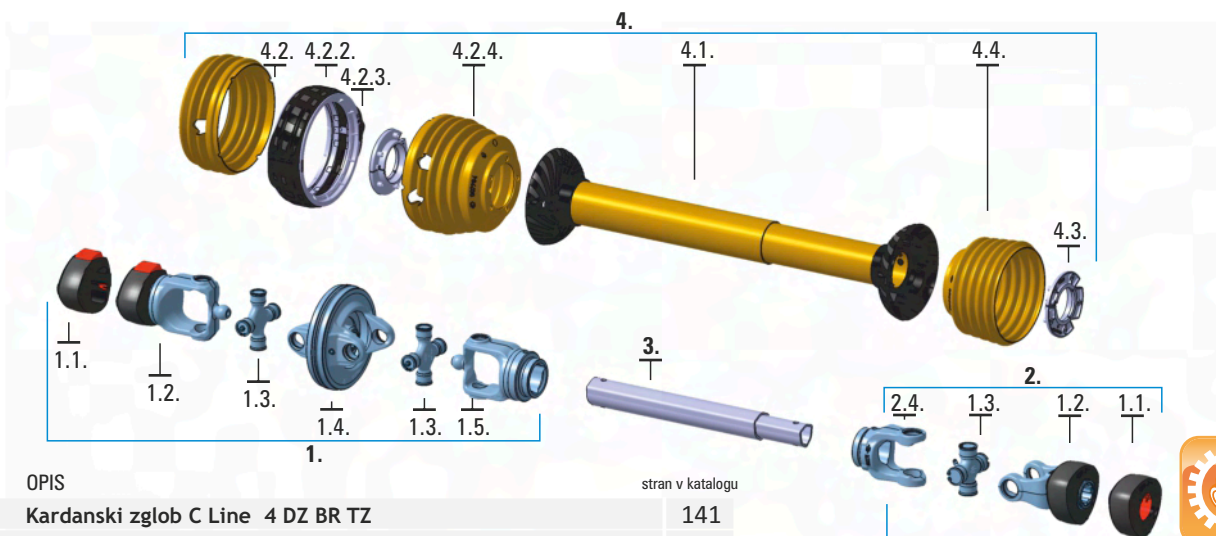

ŠT.	OPIS	stran v katalogu
1.	Kardanski zglob C Line 4 DZ BR TZ	141
1.1.	Okrov C Line 4	112
1.2.	Vilica priključna C Line 4 DZ	143
1.3.	Križ C Line 4 DZ	142
1.4.	Vilica dvojna C Line 4 DZ	145
1.3.	Križ C Line 4 DZ	142
1.5.	Vilica cevna C Line 4 DZ	144
2.	Kardanski zglob C Line 4 BR TN	95
1.1.	Okrov C Line 4	112
2.1.	Vilica priključna C Line 4	99
2.2.	Križ C Line 4	98
2.3.	Vilica cevna C Line 4 TN	100
2.B.	Kardanski zglob C Line 4 PS TN / C Line 4 PSL TN	95
2.2.2.	Sklopka C Line 4 PS / C Line 4 PSL	101
2.2.	Križ C Line 4	98
2.3.	Vilica cevna C Line 4 TN	100
2.C.	Kardanski zglob C Line 4 VS TN	95
2.2.3.	Sklopka C Line 4 VS	103
2.2.	Križ C Line 4	98
2.3.	Vilica cevna C Line 4 TN	100
2.D.	Kardanski zglob C Line 4 ST TN	95
2.2.4.	Sklopka C Line 4 ST	105
2.2.	Križ C Line 4	98
2.3.	Vilica cevna C Line 4 TN	100
2.E.	Kardanski zglob C Line 4 TS TN	95
2.2.5.	Sklopka C Line 4 TS	106
2.2.	Križ C Line 4	98
2.3.	Vilica cevna C Line 4 TN	100
3.	Cev kovinska C Line 4 DZ	146
4.	Zaščita C Line 4 DZ kpl	149
4.1.	Cev z ohišjem C Line 4	155
4.2.	Zaščitna membrana C Line 4 DZ	158
4.2.1.	Zaščitna membrana C Line 4 DZ	160
4.2.2.	Zaščitni obroč C Line 4 DZ	159
4.2.3.	Ležaj DZ 4	160
4.2.4.	Zaščitna membrana 4 DZ	159
4.3.	Ležaj C Line 4	118
4.4.	Zaščitna membrana C Line 4	118
	Veriga Tip C Line	118

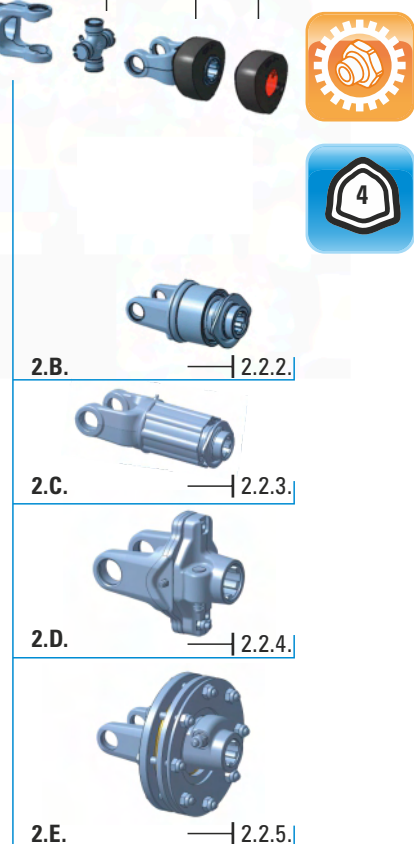

REZERVNI DELI ŠIROKOKOTNIH KARDANSKIH GREDI C Line 4 DZ DZ

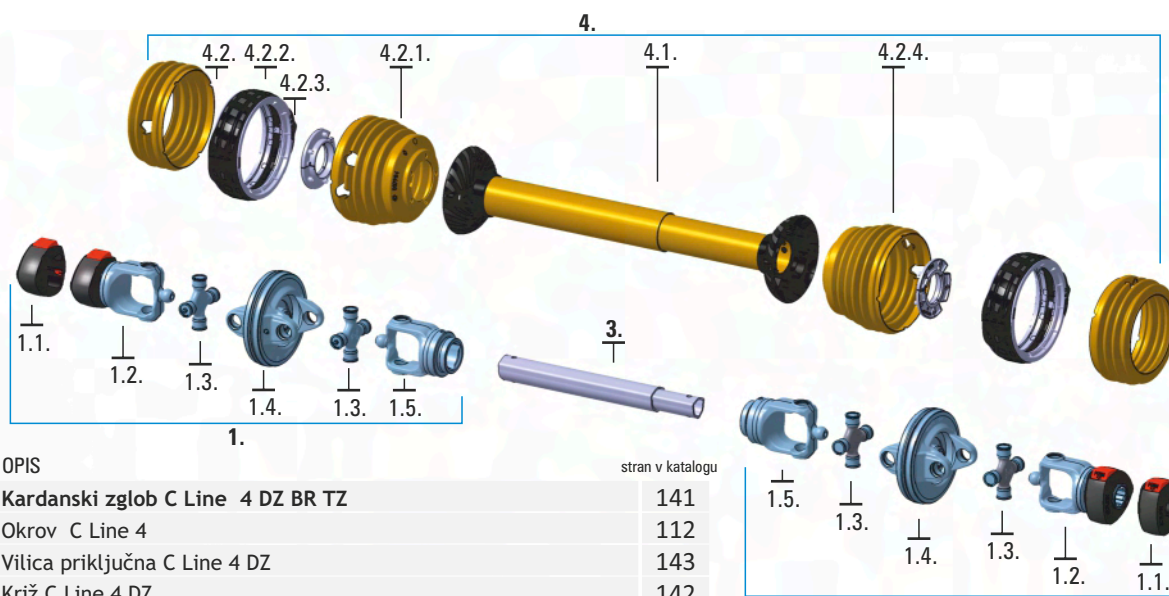

ŠT.	OPIS	stran v katalogu
1.	Kardanski zglob C Line 4 DZ BR TZ	141
1.1.	Okrov C Line 4	112
1.2.	Vilica priključna C Line 4 DZ	143
1.3.	Križ C Line 4 DZ	142
1.4.	Vilica dvojna C Line 4 DZ	145
1.3.	Križ C Line 4 DZ	142
1.5.	Vilica cevna C Line 4 DZ	144
2.	Kardanski zglob C Line 4 DZ BR TN	141
1.1.	Okrov C Line 4	112
1.2.	Vilica priključna C Line 4 DZ	143
1.3.	Križ C Line 4 DZ	142
1.4.	Vilica dvojna C Line 4 DZ	145
1.3.	Križ C Line 4 DZ	142
2.1.	Vilica cevna C Line 4 DZ	144
3.	Cev kovinska C Line 4 DZ	146
4.	Zaščita C Line 4 DZ kpl	152
4.1.	Cev z ohišjem	155
4.2.	Zaščitna membrana C Line 4 DZ	158
4.2.1.	Zaščitna membrana C Line 4 DZ	159
4.2.2.	Zaščitni obroč C Line 4 DZ	160
4.2.3.	Ležaj DZ 4	160
4.2.4.	Zaščitna membrana 4 DZ	159
	Veriga Tip C Line	118



REZERVNI DELI ŠIROKOKOTNIH KARDANSKIH GREDI C Line 6 DZ

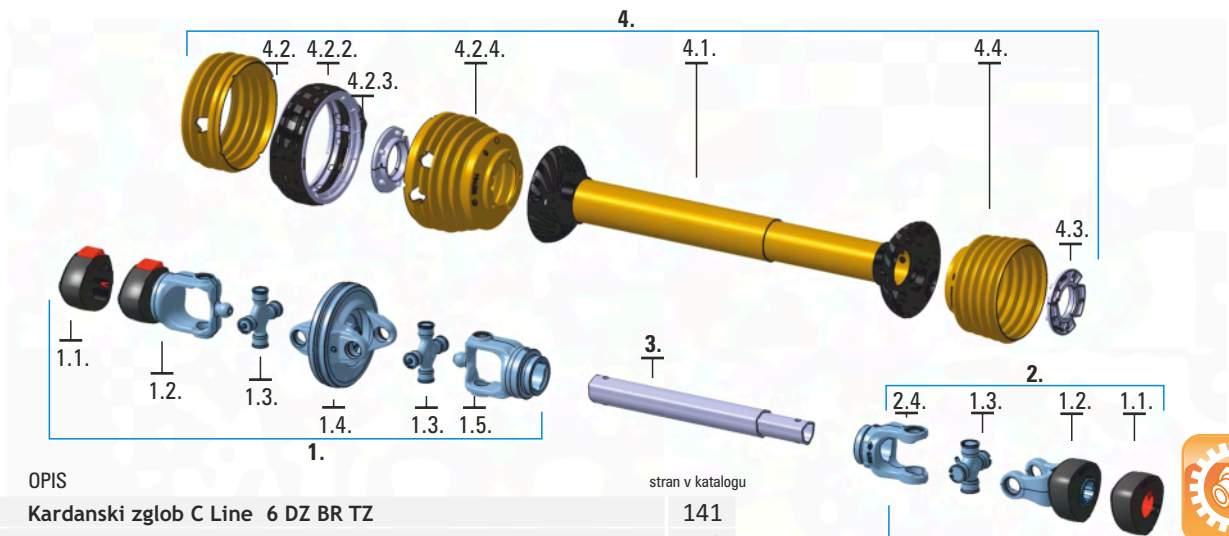

ŠT.	OPIS	stran v katalogu
1.	Kardanski zglob C Line 6 DZ BR TZ	141
1.1.	Okrov C Line 6	112
1.2.	Vilica priključna C Line 6 DZ	143
1.3.	Križ C Line 6 DZ	142
1.4.	Vilica dvojna C Line 6 DZ	145
1.3.	Križ C Line 6 DZ	142
1.5.	Vilica cevna C Line 6 DZ	144
2.	Kardanski zglob C Line 6 BR TN	96
1.1.	Okrov C Line 6	112
2.1.	Vilica priključna C Line 6	99
2.2.	Križ C Line 6	98
2.3.	Vilica cevna C Line 6 TN	100
2.B.	Kardanski zglob C Line 6 PS TN / C Line 6 PSL TN	96
2.2.2.	Sklopka C Line 6 PS / C Line 4 PSL	101
2.2.	Križ C Line 6	98
2.3.	Vilica cevna C Line 6 TN	100
2.C.	Kardanski zglob C Line 6 VS TN	96
2.2.3.	Sklopka C Line 6 VS	104
2.2.	Križ C Line 6	98
2.3.	Vilica cevna C Line 6 TN	100
2.D.	Kardanski zglob C Line 6 ST TN	96
2.2.4.	Sklopka C Line 6 ST	105
2.2.	Križ C Line 6	98
2.3.	Vilica cevna C Line 6 TN	100
2.E.	Kardanski zglob C Line 6 TS TN	96
2.2.5.	Sklopka C Line 6 TS	106
2.2.	Križ C Line 6	98
2.3.	Vilica cevna C Line 6 TN	100
3.	Cev kovinska C Line 6 DZ	147
4.	Zaščita C Line 6 DZ kpl	150
4.1.	Cev z ohišjem C Line 6	156
4.2.	Zaščitna membrana C Line 6 DZ	158
4.2.1.	Zaščitna membrana C Line 6 DZ	159
4.2.2.	Zaščitni obroč C Line 6 DZ	160
4.2.3.	Ležaj DZ 6	160
4.2.4.	Zaščitna membrana 6 DZ	159
4.3.	Ležaj C Line 6	118
4.4.	Zaščitna membrana C Line 6	118
	Veriga Tip C Line	118

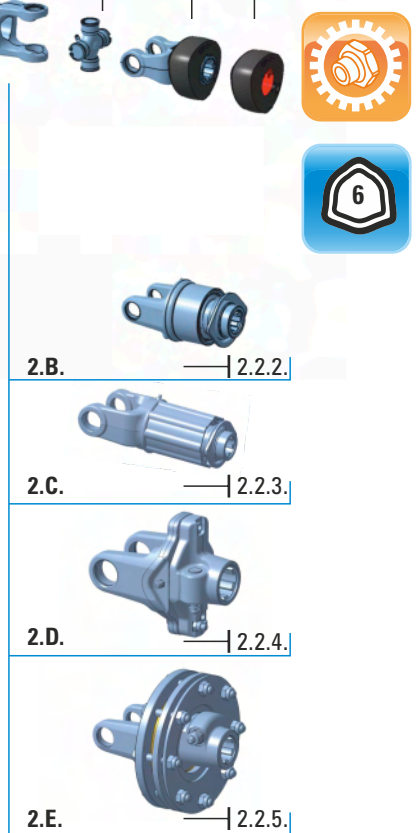

REZERVNI DELI ŠIROKOKOTNIH KARDANSKIH GREDI C Line 6 DZ DZ

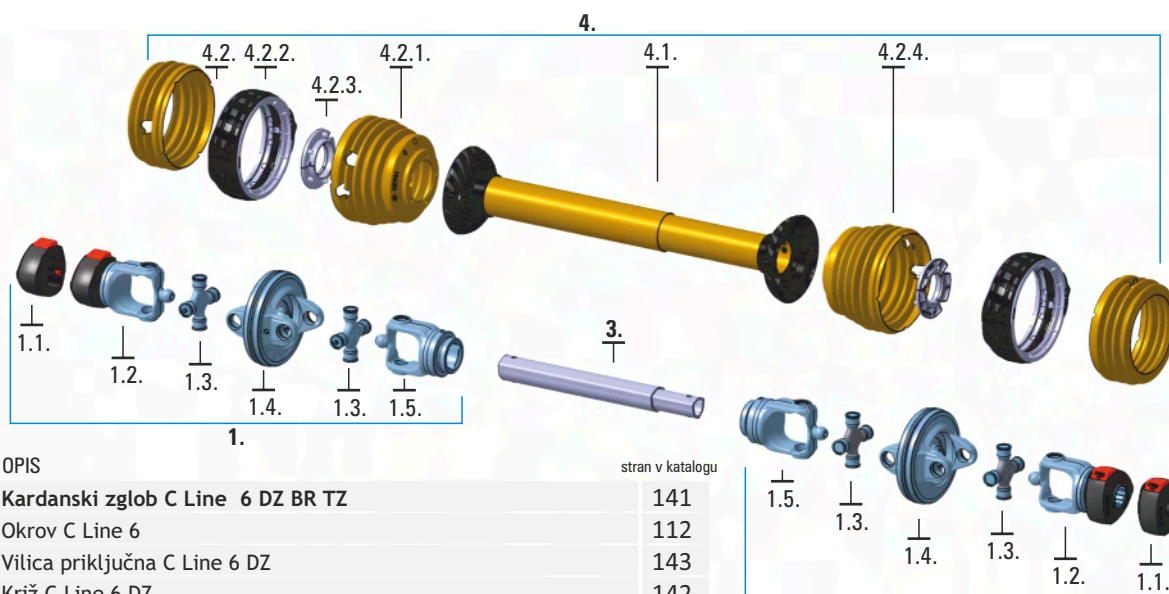

ŠT.	OPIS	stran v katalogu
1.	Kardanski zglob C Line 6 DZ BR TZ	141
1.1.	Okrov C Line 6	112
1.2.	Vilica priključna C Line 6 DZ	143
1.3.	Križ C Line 6 DZ	142
1.4.	Vilica dvojna C Line 6 DZ	145
1.3.	Križ C Line 6 DZ	142
1.5.	Vilica cevna C Line 6 DZ	144
2.	Kardanski zglob C Line 6 DZ BR TN	141
1.1.	Okrov C Line 6	112
1.2.	Vilica priključna C Line 6 DZ	143
1.3.	Križ C Line 6 DZ	142
1.4.	Vilica dvojna C Line 6 DZ	145
1.3.	Križ C Line 6 DZ	142
2.1.	Vilica cevna C Line 6 DZ	144
3.	Cev kovinska C Line 6 DZ	147
4.	Zaščita C Line 6 DZ kpl	153
4.1.	Cev z ohišjem	156
4.2.	Zaščitna membrana C Line 6 DZ	158
4.2.1.	Zaščitna membrana C Line 6 DZ	159
4.2.2.	Zaščitni obroč C Line 6 DZ	160
4.2.3.	Ležaj DZ 6	160
4.2.4.	Zaščitna membrana 6 DZ	159
	Veriga Tip C Line	118



REZERVNI DELI ŠIROKOKOTNIH KARDANSKIH GREDI C Line 8 DZ

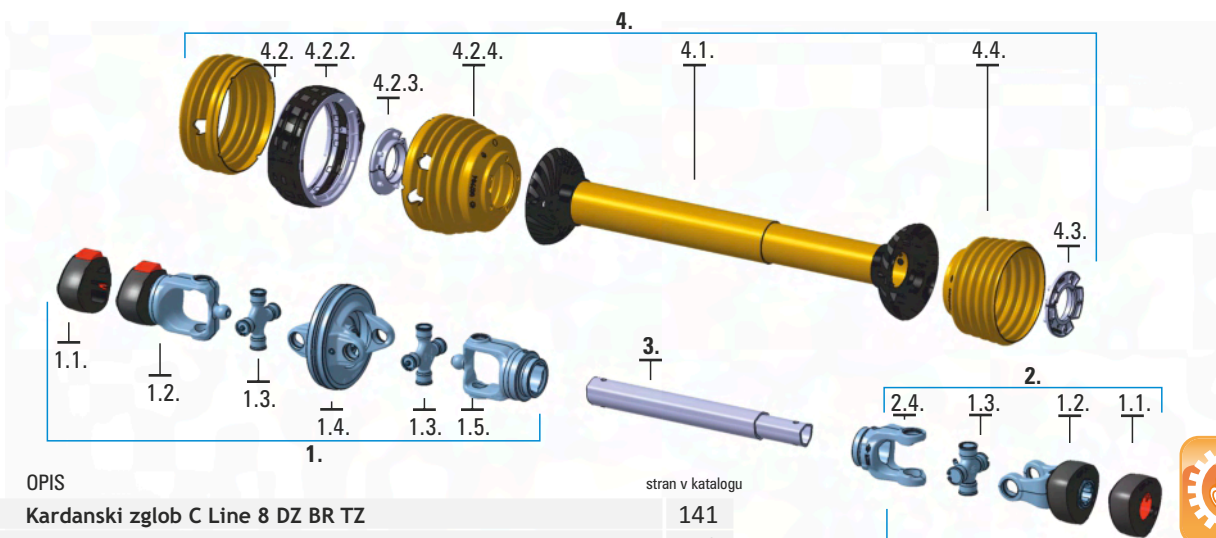

ŠT.	OPIS	stran v katalogu
1.	Kardanski zglob C Line 8 DZ BR TZ	141
1.1.	Okrov C Line 8	112
1.2.	Vilica priključna C Line 8 DZ	143
1.3.	Križ C Line 8 DZ	142
1.4.	Vilica dvojna C Line 8 DZ	145
1.3.	Križ C Line 8 DZ	142
1.5.	Vilica cevna C Line 8 DZ	144
2.	Kardanski zglob C Line 8 BR TN	97
1.1.	Okrov C Line 8	112
2.1.	Vilica priključna C Line 8	99
2.2.	Križ C Line 8	98
2.3.	Vilica cevna C Line 8 TN	100
2.B.	Kardanski zglob C Line 8 PS TN / C Line 8 PSL TN	97
2.2.2.	Sklopka C Line 8 PS / C Line 8 PSL	101
2.2.	Križ C Line 8	98
2.3.	Vilica cevna C Line 8 TN	100
2.C.	Kardanski zglob C Line 8 VS TN	97
2.2.3.	Sklopka C Line 8 VS	104
2.2.	Križ C Line 8	98
2.3.	Vilica cevna C Line 8 TN	100
2.D.	Kardanski zglob C Line 8 ST TN	97
2.2.4.	Sklopka C Line 8 ST	105
2.2.	Križ C Line 8	98
2.3.	Vilica cevna C Line 8 TN	100
2.E.	Kardanski zglob C Line 8 TS TN	97
2.2.5.	Sklopka C Line 8 TS	106
2.2.	Križ C Line 8	98
2.3.	Vilica cevna C Line 8 TN	100
3.	Cev kovinska C Line 8 DZ	148
4.	Zaščita C Line 8 DZ kpl	151
4.1.	Cev z ohišjem	157
4.2.	Zaščitna membrana C Line 8 DZ	158
4.2.1.	Zaščitna membrana C Line 8 DZ	159
4.2.2.	Zaščitni obroč C Line 8 DZ	160
4.2.3.	Ležaj DZ 8	160
4.2.4.	Zaščitna membrana 8 DZ	159
4.3.	Ležaj C Line 8	118
4.4.	Zaščitna membrana C Line 8	118
	Veriga Tip C Line	118

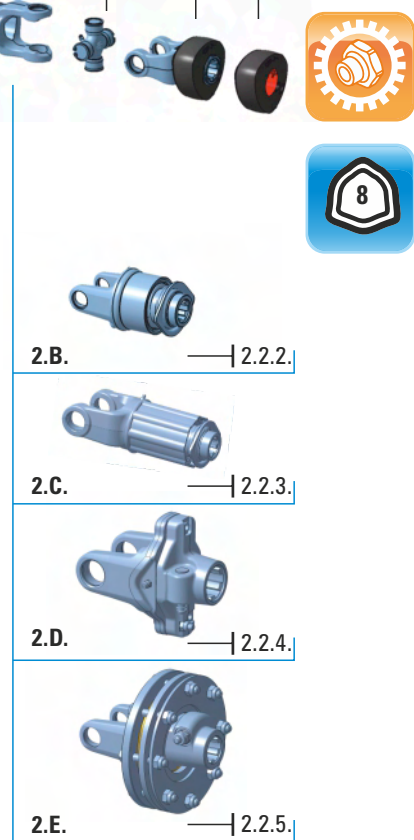

REZERVNI DELI ŠIROKOKOTNIH KARDANSKIH GREDI C Line 8 DZ DZ

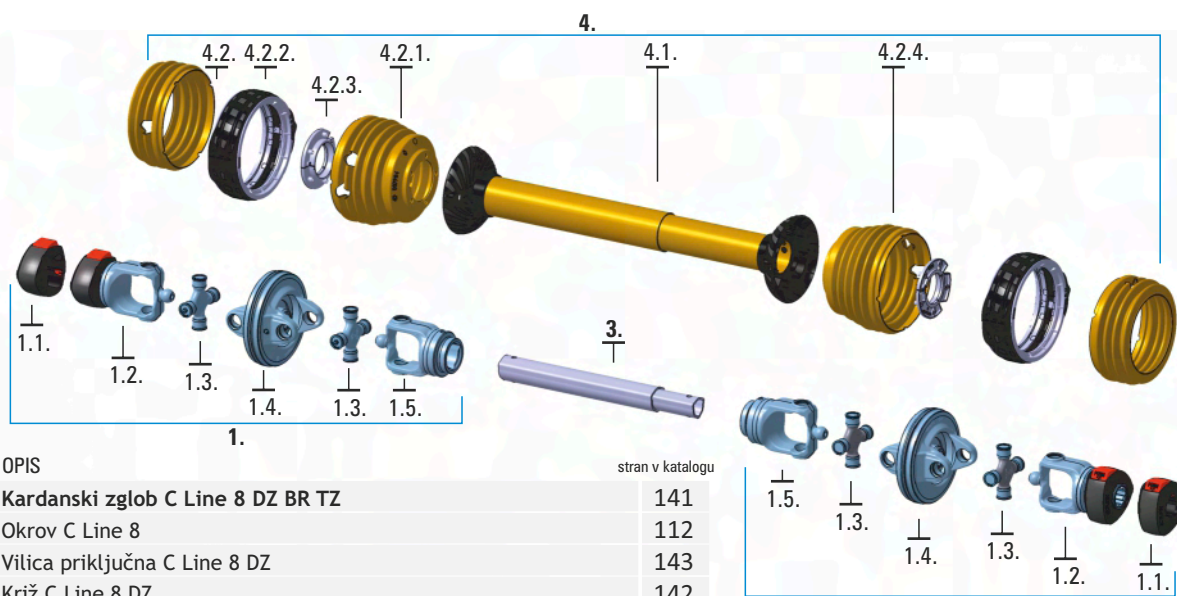







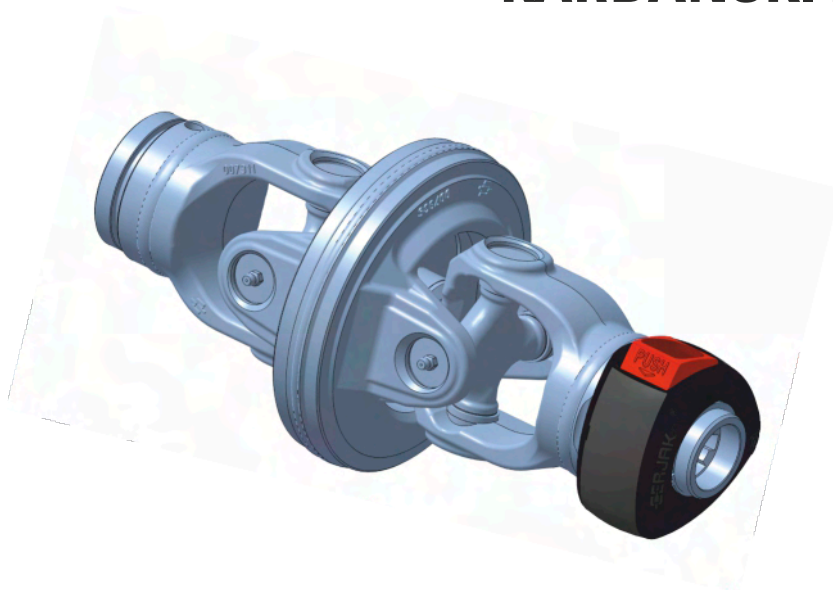



























ŠT.	OPIS	stran v katalogu
1.	Kardanski zglob C Line 8 DZ BR TZ	141
1.1.	Okrov C Line 8	112
1.2.	Vilica priključna C Line 8 DZ	143
1.3.	Križ C Line 8 DZ	142
1.4.	Vilica dvojna C Line 8 DZ	145
1.3.	Križ C Line 8 DZ	142
1.5.	Vilica cevna C Line 8 DZ	144
2.	Kardanski zglob C Line 8 DZ BR TN	141
1.1.	Okrov C Line 8	112
1.2.	Vilica priključna C Line 8 DZ	143
1.3.	Križ C Line 8 DZ	142
1.4.	Vilica dvojna C Line 8 DZ	145
1.3.	Križ C Line 8 DZ	142
2.1.	Vilica cevna C Line 8 DZ	144
3.	Cev kovinska C Line 8 DZ	148
4.	Zaščita C Line 8 DZ kpl	154
4.1.	Cev z ohišjem	157
4.2.	Zaščitna membrana C Line 8 DZ	158
4.2.1.	Zaščitna membrana C Line 8 DZ	159
4.2.2.	Zaščitni obroč C Line 8 DZ	160
4.2.3.	Ležaj DZ 8	160
4.2.4.	Zaščitna membrana 8 DZ	159
	Veriga Tip C Line	118



REZERVNI DELI ŠIROKOKOTNIH KARDANSKIH GREDI KARDANSKI ZGLOB DZ



ARTIKEL	OPIS		EAN 13 ČRTNA KODA
021886R	C Line 4 DZ BR TN 1 3/8"z6	 1 3/8"z6	3838433005654 
009538R	C Line 4 DZ BR TZ 1 3/8"z6	 1 3/8"z6	3838433004473 
021815R	C Line 4 DZ BR TZ 1 3/8"z21	 1 3/8"z21	3838433005173 
021816R	C Line 4 DZ BR TZ 32/38 z8	 32/38 z8	3838433005180 
021892R	C Line 6 DZ BR TN 1 3/8"z6	 1 3/8"z6	3838433005715 
009539R	C Line 6 DZ BR TZ 1 3/8"z6	 1 3/8"z6	3838433004480 
021780R	C Line 6 DZ BR TZ 1 3/8"z21	 1 3/8"z21	3838433004831 
021781R	C Line 6 DZ BR TZ 32/38 z8	 32/38 z8	3838433004848 
021782R	C Line 6 DZ BR TZ 1 3/4"z6	 1 3/4"z6	3838433004855 
021783R	C Line 6 DZ BR TZ 1 3/4"z20	 1 3/4"z20	3838433004862 
007908R	C Line 8 DZ BR TN 1 3/8"z6	 1 3/8"z6	3838433005685 
021910R	C Line 8 DZ BR TN 1 3/4"z6	 1 3/4"z6	3838433005760 
007907R	C Line 8 DZ BR TZ 1 3/8"z6	 1 3/8"z6	3838433002424 
021772R	C Line 8 DZ BR TZ 1 3/8"z21	 1 3/8"z21	3838433004787 
021774R	C Line 8 DZ BR TZ 32/38 z8	 32/38 z8	3838433004794 
021775R	C Line 8 DZ BR TZ 1 3/4"z6	 1 3/4"z6	3838433004800 
021776R	C Line 8 DZ BR TZ 1 3/4"z20	 1 3/4"z20	3838433004817 

REZERVNI DELI ŠIROKOKOTNIH KARDANSKIH GREDI
KRIŽ C Line DZ / KPL



ARTIKEL OPIS

007981R C Line 4 DZ 23,8x90,4

3838433004428

EAN 13 ČRTNA KODA



007982R C Line 6 DZ 27x104,4

3838433004435

























011328R C Line 8 DZ 30,2x125

3838433002431



REZERVNI DELI ŠIROKOKOTNIH KARDANSKIH GREDI PRIKLJUČNE VILICE C Line DZ











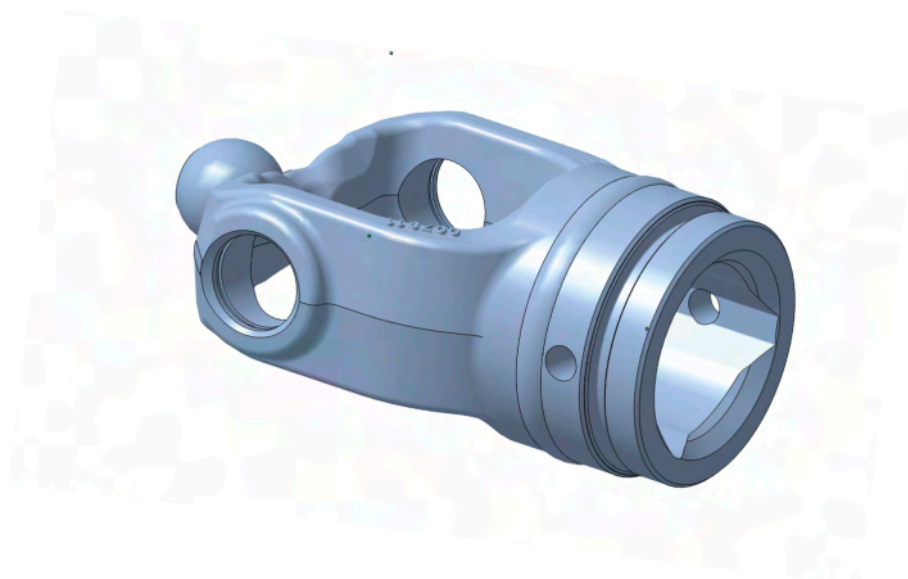

ARTIKEL	OPIS		EAN 13 ČRTNA KODA
018161R	C Line 4 DZ 1 3/8"z6	 1 3/8"z6	3838433004091 
021719R	C Line 4 DZ 1 3/8"z21	 1 3/8"z21	3838433004312 
021720R	C Line 4 DZ 32/38 z8	 32/38z8	3838433004329 
020590R	C Line 6 DZ 1 3/8"z6	 1 3/8"z6	3838433002585 
020641R	C Line 6 DZ 1 3/8"z21	 1 3/8"z21	3838433002820 
020642R	C Line 6 DZ 32/38 z8	 32/38z8	3838433002837 
020591R	C Line 6 DZ 1 3/4"z6	 1 3/4"z6	3838433002592 
020643R	C Line 6 DZ 1 3/4"z20	 1 3/4"z20	3838433002844 
007890R	C Line 8 DZ 1 3/8"z6	 1 3/8"z6	3838433002370 
020556R	C Line 8 DZ 1 3/8"z21	 1 3/8"z21	3838433002554 
020557R	C Line 8 DZ 32/38 z8	 32/38z8	3838433002561 
007892R	C Line 8 DZ 1 3/4"z6	 1 3/4"z6	3838433002387 
020554R	C Line 8 DZ 1 3/4"z20	 1 3/4"z20	3838433002547 



REZERVNI DELI ŠIROKOKOTNIH KARDANSKIH GREDI

CEVNE VILICE C Line DZ



ARTIKEL	OPIS		EAN 13 ČRTNA KODA
018165R	C Line 4 DZ TN		3838433004114 
018162R	C Line 4 DZ TZ		3838433004107 
020645R	C Line 6 DZ TN		3838433002868 
020644R	C Line 6 DZ TZ		3838433002851 
018158R	C Line 8 DZ TN		3838433002752 
007883R	C Line 8 DZ TZ		3838433002356 

REZERVNI DELI ŠIROKOKOTNIH KARDANSKIH GREDI
DVOJNE VILICE C Line DZ



ARTIKEL	OPIS	EAN 13 ČRTNA KODA
018166R	C Line 4 DZ	3838433004510
009535R	C Line 6 DZ	3838433004466
007884R	C Line 8 DZ	3838433002363

REZERVNI DELI ŠIROKOKOTNIH KARDANSKIH GREDI

KOVINSKA CEV C Line 4 DZ / KPL

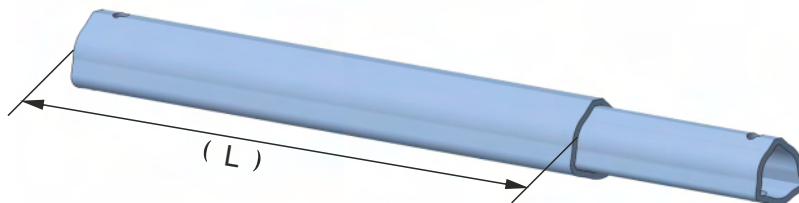

ARTIKEL	OPIS		EAN 13 ČRTNA KODA
021872R	4 kpl za kk710 (550)	3838433005548	
021874R	4 kpl za kk810 (650)	3838433005562	
021876R	4 kpl za kk910 (750)	3838433005586	
021878R	4 kpl za kk1010 (850)	3838433005609	
021880R	4 kpl za kk1210 (1050)	3838433005623	
021882R	4 kpl za kk1410 (1250)	3838433005647	

REZERVNI DELI ŠIROKOKOTNIH KARDANSKIH GREDI
KOVINSKA CEV C Line 6 DZ / KPL

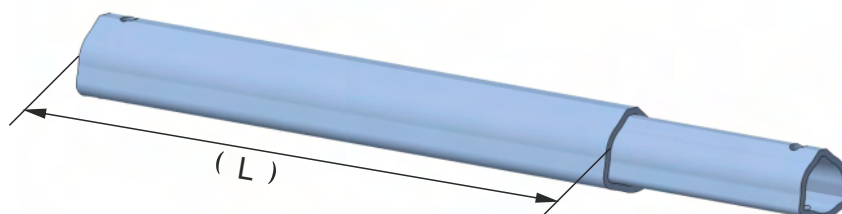

ARTIKEL	OPIS		EAN 13 ČRTNA KODA
006630R	6 kpl za kk710 (535)	3831111018502	
006632R	6 kpl za kk810 (635)	3831111018526	
006634R	6 kpl za kk910 (735)	3831111018540	
006636R	6 kpl za kk1010 (830)	3831111018564	
006638R	6 kpl za kk1210 (1030)	3831111018588	
006640R	6 kpl za kk1410 (1230)	3831111018601	

REZERVNI DELI ŠIROKOKOTNIH KARDANSKIH GREDI

KOVINSKA CEV C Line 8 DZ / KPL

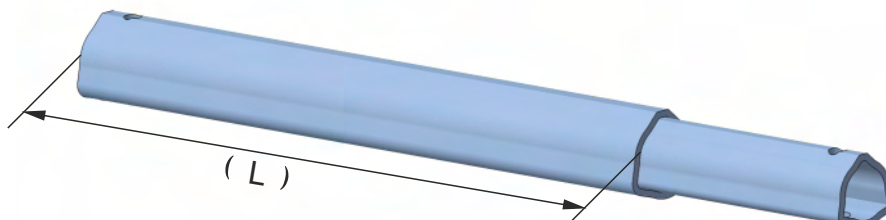

ARTIKEL	OPIS		EAN 13 ČRTNA KODA
009755R	8 kpl za kk710 (510)	3831111024480	
009757R	8 kpl za kk810 (610)	3831111024503	
009759R	8 kpl za kk910 (710)	3831111024527	
009761R	8 kpl za kk1010 (810)	3831111024541	
009763R	8 kpl za kk1210 (1010)	3831111024565	
009766R	8 kpl za kk1410 (1210)	3831111024596	

REZERVNI DELI ŠIROKOKOTNIH KARDANSKIH GREDI ZAŠČITA C Line 4 DZ / KPL



ARTIKEL	OPIS		EAN 13 ČRTNA KODA
021837R	C Line 4 DZ za kk710 (450)	3838433005388	
021839R	C Line 4 DZ za kk810 (550)	3838433005401	
021841R	C Line 4 DZ za kk910 (650)	3838433005425	
021843R	C Line 4 DZ za kk1010 (750)	3838433005449	
021845R	C Line 4 DZ za kk1210 (950)	3838433005463	
021847R	C Line 4 DZ za kk1410 (1150)	3838433005487	

REZERVNI DELI ŠIROKOKOTNIH KARDANSKIH GREDI ZAŠČITA C Line 6 DZ / KPL

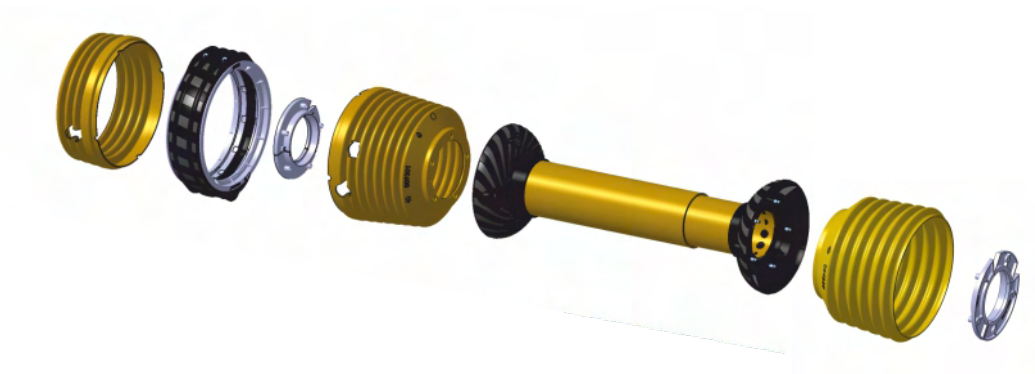

ARTIKEL	OPIS		EAN 13 ČRTNA KODA
021802R	C Line 6 DZ za kk710 (430)	3838433005043	
021804R	C Line 6 DZ za kk810 (530)	3838433005067	
021806R	C Line 6 DZ za kk910 (630)	3838433005081	
021808R	C Line 6 DZ za kk1010 (730)	3838433005104	
021810R	C Line 6 DZ za kk1210 (930)	3838433005128	
021812R	C Line 6 DZ za kk1410 (1130)	3838433005142	

REZERVNI DELI ŠIROKOKOTNIH KARDANSKIH GREDI ZAŠČITA C Line 8 DZ / KPL

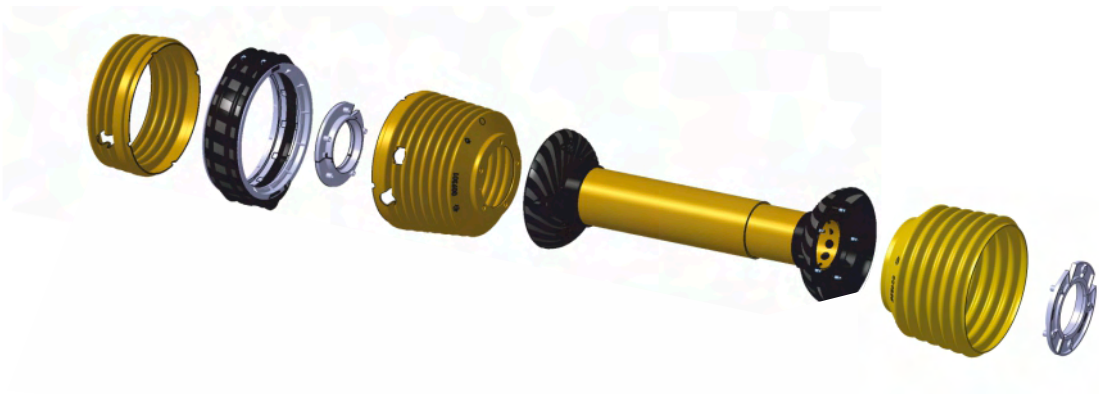

ARTIKEL	OPIS		EAN 13 ČRTNA KODA
021762R	C Line 8 DZ za kk710 (390)	3838433004688	
020515R	C Line 8 DZ za kk810 (490)	3838433002523	
021765R	C Line 8 DZ za kk910 (590)	3838433004718	
021767R	C Line 8 DZ za kk1010 (690)	3838433004732	
021769R	C Line 8 DZ za kk1210 (890)	3838433004756	
021771R	C Line 8 DZ za kk1410 (1090)	3838433004770	

REZERVNI DELI ŠIROKOKOTNIH KARDANSKIH GREDI ZAŠČITA C Line 4 DZ DZ / KPL



ARTIKEL	OPIS		EAN 13 ČRTNA KODA
024042R	C Line 4 DZ DZ za kk710 (450)	3838433008563	
023785R	C Line 4 DZ DZ za kk810 (550)	3838433008136	
022559R	C Line 4 DZ DZ za kk910 (650)	3838433006491	
022558R	C Line 4 DZ DZ za kk1010 (750)	3838433006484	
021887R	C Line 4 DZ DZ za kk1210 (950)	3838433005661	
022671R	C Line 4 DZ DZ za kk1410 (1150)	3838433006743	

REZERVNI DELI ŠIROKOKOTNIH KARDANSKIH GREDI ZAŠČITA C Line 6 DZ DZ / KPL



ARTIKEL	OPIS		EAN 13 ČRTNA KODA
024045R	C Line 6 DZ DZ za kk710 (430)	3838433008594	
024044R	C Line 6 DZ DZ za kk810 (530)	3838433008587	
024043R	C Line 6 DZ DZ za kk910 (630)	3838433008570	
022053R	C Line 6 DZ DZ za kk1010 (730)	3838433006033	
021890R	C Line 6 DZ DZ za kk1210 (930)	3838433005708	
021893R	C Line 6 DZ DZ za kk1410 (1130)	3838433005722	

REZERVNI DELI ŠIROKOKOTNIH KARDANSKIH GREDI ZAŠČITA C Line 8 DZ DZ / KPL

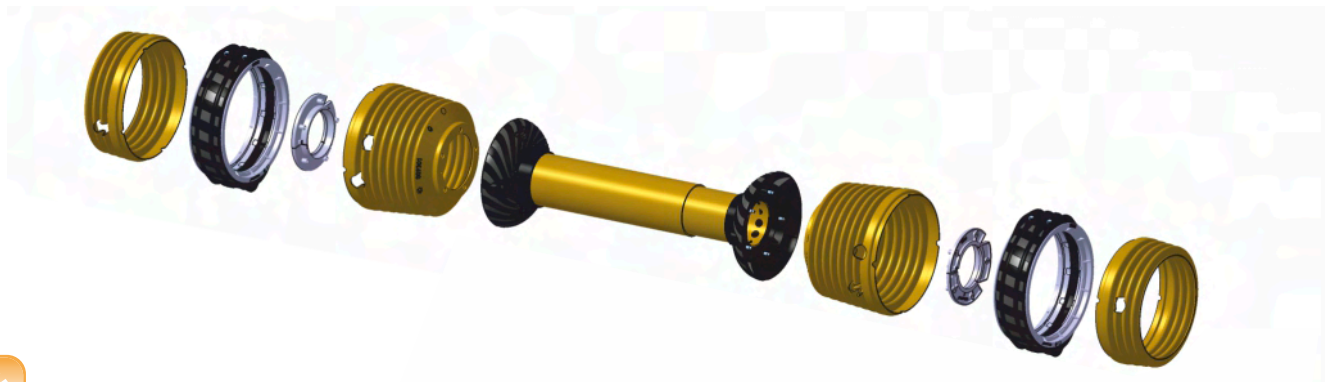

ARTIKEL	OPIS		EAN 13 ČRTNA KODA
024048R	C Line 8 DZ DZ za kk710 (390)	3838433008624	
024047R	C Line 8 DZ DZ za kk810 (490)	3838433008617	
024046R	C Line 8 DZ DZ za kk910 (590)	3838433008600	
022802R	C Line 8 DZ DZ za kk1010 (690)	3838433007030	
021901R	C Line 8 DZ DZ za kk1210 (890)	3838433005739	
021909R	C Line 8 DZ DZ za kk1410 (1090)	3838433005753	

REZERVNI DELI ŠIROKOKOTNIH KARDANSKIH GREDI CEV Z OHIŠJEM C Line 4 DZ



ARTIKEL	OPIS		EAN 13 ČRTNA KODA
021822R	C Line 4 DZ za kk710 (450)	3838433005234	
021824R	C Line 4 DZ za kk810 (550)	3838433005258	
021826R	C Line 4 DZ za kk910 (650)	3838433005272	
021828R	C Line 4 DZ za kk1010 (750)	3838433005296	
021830R	C Line 4 DZ za kk1210 (950)	3838433005319	
021832R	C Line 4 DZ za kk1410 (1150)	3838433005333	

REZERVNI DELI ŠIROKOKOTNIH KARDANSKIH GREDI CEV Z OHIŠJEM C Line 6 DZ



ARTIKEL OPIS

021787R C Line 6 DZ za kk710 (430)

3838433004909

EAN 13 ČRTNA KODA



021789R C Line 6 DZ za kk810 (530)

3838433004923



021791R C Line 6 DZ za kk910 (630)

3838433004947



021793R C Line 6 DZ za kk1010 (730)

3838433004961



021795R C Line 6 DZ za kk1210 (930)

3838433004985



021797R C Line 6 DZ za kk1410 (1130)

3838433005005



REZERVNI DELI ŠIROKOKOTNIH KARDANSKIH GREDI CEV Z OHIŠJEM C Line 8 DZ



ARTIKEL	OPIS		EAN 13 ČRTNA KODA
021750R	C Line 8 DZ za kk710 (390)	3838433004565	
021752R	C Line 8 DZ za kk810 (490)	3838433004589	
021754R	C Line 8 DZ za kk910 (590)	3838433004602	
021756R	C Line 8 DZ za kk1010 (690)	3838433004626	
021758R	C Line 8 DZ za kk1210 (890)	3838433004640	
021760R	C Line 8 DZ za kk1410 (1090)	3838433004664	

REZERVNI DELI ŠIROKOKOTNIH KARDANSKIH GREDI

ZAŠČITNA MEMBRANA C Line DZ / KPL

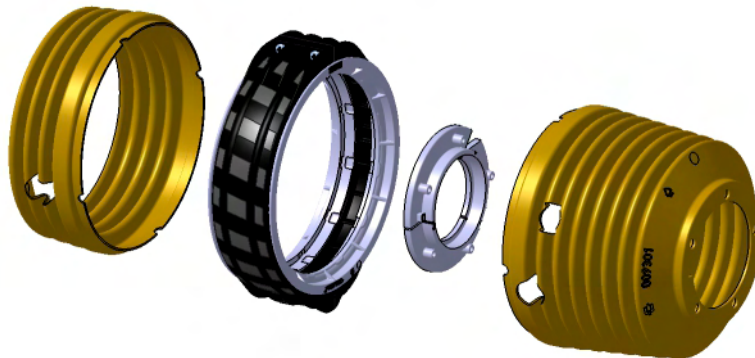

ARTIKEL OPIS

EAN 13 ČRTNA KODA

022763R C Line 4 DZ

3838433006637



022764R C Line 6 DZ

3838433006620



022765R C Line 8 DZ

3838433006613



REZERVNI DELI ŠIROKOKOTNIH KARDANSKIH GREDI DELI ZAŠČITE C Line DZ

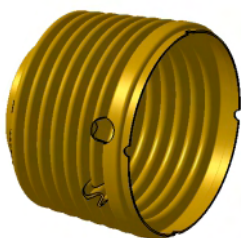

ARTIKEL	OPIS		EAN 13 ČRTNA KODA
020811R	C Line 4 DZ	3838433004534	
020810R	C Line 6 DZ	3838433004527	
007894R	C Line 8 DZ	3838433002394	



ARTIKEL	OPIS		EAN 13 ČRTNA KODA
021854R	C Line 4 DZ	3838433005494	
021813R	C Line 6 DZ	3838433005159	
020516R	C Line 8 DZ	3838433002530	

REZERVNI DELI ŠIROKOKOTNIH KARDANSKIH GREDI

DELI ZAŠČITE C Line DZ



ARTIKEL	OPIS		EAN 13 ČRTNA KODA
009302R	4 DZ	3838433004442	
009463R	6 DZ	3838433004459	
007896R	8 DZ	3838433002417	



ARTIKEL	OPIS		EAN 13 ČRTNA KODA
009540R	DZ 4	3838433004497	
009541R	DZ 6	3838433004503	
007895R	DZ 8	3838433002400	

POVPRAŠEVANJE NESTANDARDNE KARDANSKE GREDI

Podatki o naročniku:

Ime in priimek: _____ Naslov: _____

Telefon: _____ E-mail: _____

Podatki o plačniku (ne izpolnjuj, če je plačnik enak naročniku):

Ime in priimek: _____ Naslov: _____

Telefon: _____ E-mail: _____

Podatki o dostavi (ne izpolnjuj, če je naslov enak naročniku):

Ime in priimek: _____ Naslov: _____

Telefon: _____ E-mail: _____

Podatki o pogonskem agregatu (traktorju):

PROIZVAJALEC / MODEL / TIP: _____

NAZIVNA MOČ kW/KS: _____ kW _____ KS ŠTEVILO OBRATOV (min): 540/540e/750 1000 ostalo: _____

Podatki o delovnem stroju (priključku):

PROIZVAJALEC / MODEL / TIP: _____

Delovno število vrtljajev (min⁻¹): _____ Maksimalni delovni moment (Nm): _____

Podatki o profilu priklopa:

- A**
- 1 3/8" z6
 - 1 3/8" z21
 - 1 3/4" z6
 - 1 3/4" z20
 - 32/38 z8
 - ostalo: _____

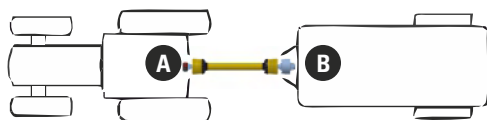

- B**
- 1 3/8" z6
 - 1 3/8" z21
 - 1 3/4" z6
 - 1 3/4" z20
 - 32/38 z8
 - ostalo: _____

Podatki o dolžini kardanske gredi:

- Vlečeni priključek z vrtiščem med zgloboma.

Lmin _____ mm

Lmax _____ mm

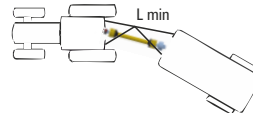
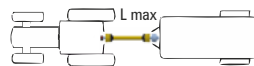
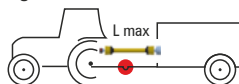

- Vlečeni priključek z vrtiščem pred zglobom na traktorju.

Lmin _____ mm

Lmax _____ mm

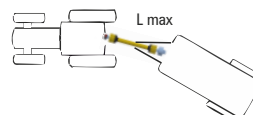
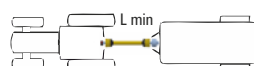
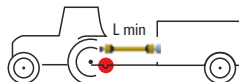

- Nošeni priključek.

Lmin _____ mm

Lmax _____ mm

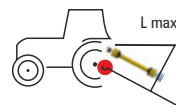
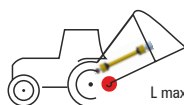
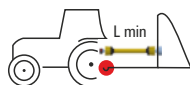

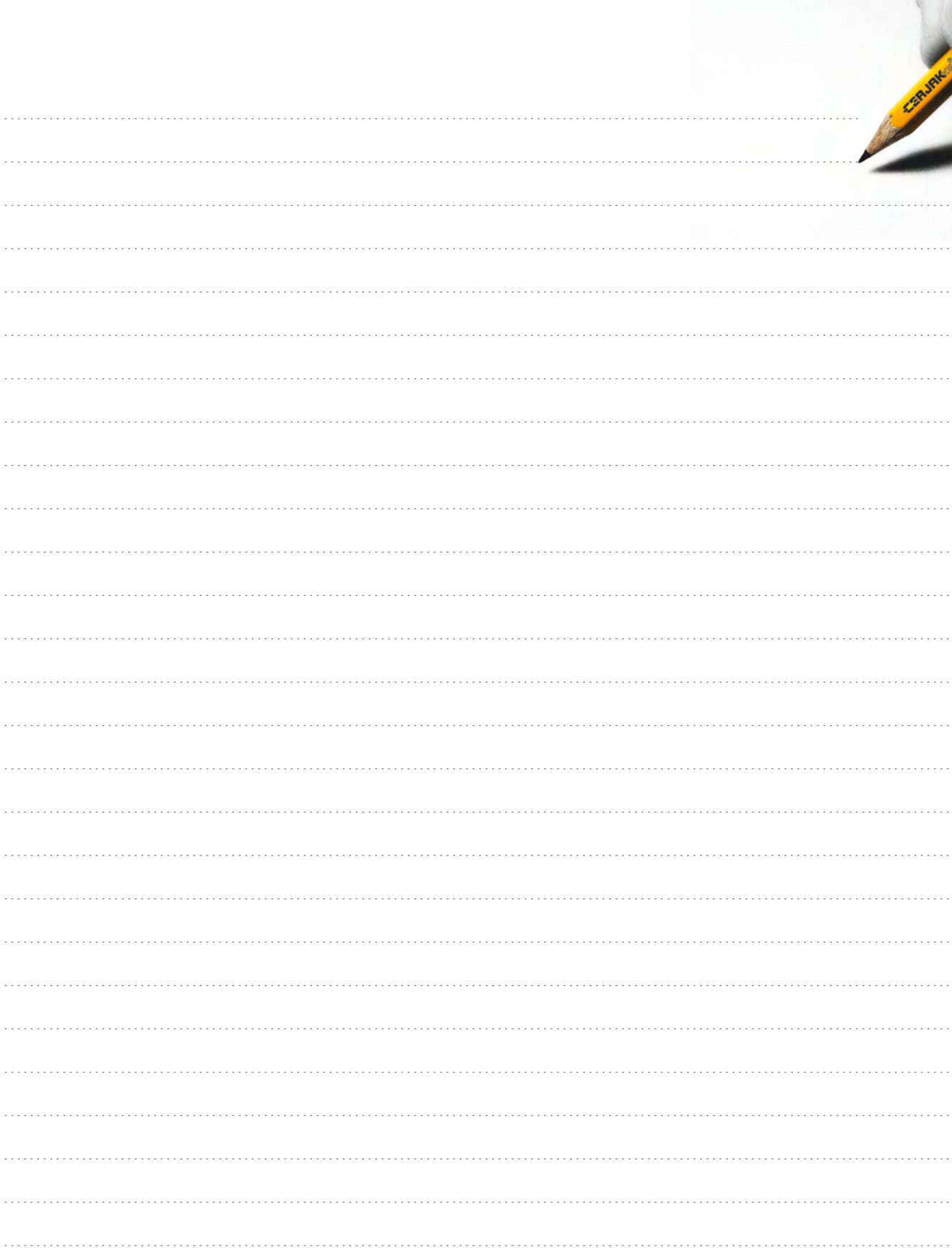



CERJAK

Cerjak d.o.o.,
Žadovinek 38,
SI-8273 Leskovec pri Krškem,
Slovenija
Tel.: +386 (0)7 49 21 682
Fax: +386 (0)7 49 21 683
E-mail: info@cerjak.si
Internet: www.cerjak.si



C Line

Ver. 2