

CERJAK^{KG}



C Line

C Line DZ

CATALOGUE

PTO DRIVE SHAFTS

C Line



C Line



C Line DZ

*It is forbidden to multiply or copy the catalogue or parts of the catalogue without prior approval of the company Cerjak d.o.o.
All information contained in this catalogue replaces all information contained in former publications.
Consequently, some information contained in former publications could not be valid anymore.*

The catalogue has been prepared with due diligence and precision, but we do not bear any responsibility for typographic errors and incomplete information. We reserve the right to change the specifications and technical data without any prior notification.

	PAGE
<u>INTRODUCTION</u>	5
<u>PTO DRIVE SHAFTS</u>	17
<u>WIDE-ANGLE PTO DRIVE SHAFTS</u>	57
<u>SPARE PARTS</u>	86
<u>PTO DRIVE SHAFTS</u>	
<u>SPARE PARTS</u>	133
<u>WIDE-ANGLE PTO DRIVE SHAFTS</u>	



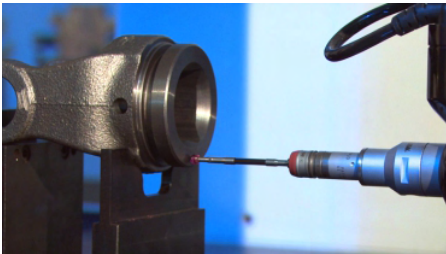

Dear business partners,

Dear customers,

Cerjak d.o.o. is a family-owned company with a long tradition - we have been producing PTO drive shafts since 1981. With innovative solutions that are included as standard in the C Line PTO drive shaft program, we want to offer you something more and thereby improve your experience while using them.

At the same time, we offer OEMs support in the development of new machines and the possibility of purpose-built components as well as PTO drive shafts.

We stand for quality products, as we are aware of the importance of product quality for each party. Quality components are supplied to us by verified European suppliers. Our PTO drive shafts are manufactured in accordance with all safety regulations and guidelines and marked with the **CE** mark. We implement the company's quality system in accordance with the ISO 9001:2015 standard.

In the company, we are aware that development is a constant. Therefore, we will add new and improved products to our sales program in the future. We are focusing on the digitization of PTO drive shafts, so that we can offer you solutions that will further improve your user experience and at the same time provide a more accurate operation control.

Business partners and customers, thank you for your trust and our long-term business partnerships. A big thank you also to everyone who already showed interest and desire to build a partnership in the future. I believe you have done the right decision.

PTO drive shafts **CERJAK^{KG}** - the right decision!

Matija Cerjak
Commercial director

SEVEN ADVANTAGES OF THE C LINE PTO DRIVE SHAFTS



The C Line PTO drive shafts are recognizable because of the C Line patented coupling mechanism and the flexible cone. The PTO drive shafts are distinguished through user-friendliness, compactness and appealing design. All our PTO shafts meet CE requirements and are made from European components.

In our sales program we offer standard and wide-angle PTO drive shafts. Regarding the customers' needs there are different sizes, lengths and safety elements (clutches) available.

PATENTED COUPLING MECHANISM C Line

Our patented coupling mechanism C Line is the result of our knowledge and development. It enables easy coupling and uncoupling of the PTO drive shaft. The cover offers more comfort to the user because of its ergonomically and compact form. The users' security is assured, because he can't get entangled in protruding parts of the yoke. There is also less dirt present at handling and there are fewer difficulties connected with it.

EASY MAINTENANCE

Our PTO drive shafts enable the user easy maintenance. The greasing nipples on standard crosses are positioned under angle to enable the user better access. Easier access is also possible because of the flexible cone. We listened to the wishes of our customers and placed the greasing nipple at wide-angle PTO's into the cross bearing. The other novelty, we introduced with wide-angle PTO drive shafts is in line greasing. We wanted to additionally simplify the main-tenance and extend the lifespan of joints.

MADE IN EU

The quality of products is for us and for our customers of high significance. This is why we use European made components in our products. We also perform constant control of incoming materials and the control of finished products. In our company we work according to ISO 9001.

SAFETY

In our company we are aware of the importance of the users' safety. That's why our PTO's are produced according to legal regulations and European directives and bear the CE sign.

FLEXIBLE CONE

We designed, especially for our customers, a protective cone which is flexible and enables easier handling while coupling the PTO on the tractor or working machine. The flexible cone offers additional comfort when coupling the PTO, because you can get a good grip in the limited shaft space.

PATENTED SHEAR BOLT CLUTCH (ST)

Our patented shear bolt clutch (ST) boasts an ergonomic and more compact design. It is more symmetrical, which affects the reduction of vibrations due to eccentric masses. The PTO drive shaft can be used on another machine as several different torque settings are possible on one clutch. Changing the safety element is simplified due to the shape of the groove of the nut, which prevents the nut from rotating when screwing - only one spanner is needed for the change.

MAINTENANCE OF OUR FRICTION CLUTCH (TS)

There are four holes on the friction clutch that allow the friction surface to be relieved before the season. The torque remains set in the meantime - it does not need to be readjusted. Due to the shape of the yoke adjustment is easier and more ergonomic. The yoke design holds the screw in place during adjustment and can be performed with just 1 spanner instead of two.



DESCRIPTIONS

PTO Drive shaft C Line 4 VS 900Nm kk910 (1140) 1 3/4"z6; 1 3/8"z6

1. Basic name	
2. Sales program and size code	
3. Type of PTO drive shaft with regard to the safety element	
4. Torque of safety element	
5. Length of PTO drive shaft between pivot points (cross-cross) in mm (a)	
6. Length of PTO drive shaft (end-end) in mm (b)	
7. Coupling profile on the side of the mover aggregate (c)	
8. Coupling profile on the side of the working machine (d)	

Note:

- (a) Length of PTO drive shaft between pivots points (joint-joint) in mm, in compressed state, rounded to 10mm
- (b) Length of the entire PTO drive shaft in compressed state rounded up by 10 mm
- (c) Coupling profile on the side of the mover is not given, if 1 3/8"z6 is on both sides.
- (d) Coupling profile on the side of the working machine is not given, if 1 3/8"z6 is on both sides.

Cross C Line 4 27x74,6

1. Basic name	
2. Sales program and size code	
3. Diameter of bearing bore (mm)	
4. Length of joint without spring clips (mm)	

DESCRIPTIONS

Clutch C Line 4 VS 900Nm 1 3/8"z6

- 1. Basic name
- 2. Sales program and size code
- 3. Type of clutch with regard to the safety element
- 4. Maximum torque of the safety element
- 5. Coupling profile

Joint C Line 4 TS (800Nm) TN 1 3/8"z6

- 1. Basic name
- 2. Sales program and size code
- 3. Type of universal joint with regard to the safety element
- 4. Maximum torque of the safety element
- 5. Position of tube yoke with regard to the point of installation (TN - inner or TZ - outer)
- 6. Coupling profile

Outer yoke C Line 4 DZ SNM 1 3/8"z6

- 1. Basic name
- 2. Sales program and size code
- 3. Type of outer yoke
- 4. Type of connection point (applies only to SNM)
- 5. Coupling profile

Tube yoke C Line 4 TZ

- 1. Basic name
- 2. Sales program and size code
- 3. Position of tube yoke with regard to the point of installation (TN - inner or TZ - outer)

LEGEND

FORM AND SIZE OF PTO DRIVE SHAFT TUBES



NOMINAL POWER HANDLED BY THE PTO DRIVE SHAFT



TYPE OF SAFETY ELEMENT, OPERATING DIRECTION AND TORQUE BORNE OF THE SAFETY ELEMENT



MAXIMUM OPERATING ANGLE



NUMBER OF ROTATIONS (RPM) OF THE MOVER



COUPLING PROFILE



HOW TO CHOOSE AN APPROPRIATE PTO DRIVE SHAFT...

1. SIZE

In choosing the appropriate size of the PTO drive shaft you must bear in mind the requirements of the working machine and the torque produced by the mover (tractor). Usually we do not know the torque produced by the tractor, but we know the power of the tractor and the nominal rotational speed. Torque calculation:

$$M \text{ (Nm)} = \frac{P \text{ (kW)} \times 9553}{n \text{ (min}^{-1}\text{)}}$$

When choosing the size of the PTO drive shaft types BR, BR+, PS or PSL make sure that the calculated torque does not exceed the maximum torque specified in the table. For a better notion about dimension, used at single sizes, you can help yourself with the table below.

Size	540 min ⁻¹			1000 min ⁻¹		
	M (Nm)	P (kW)	(HP) KS	M (Nm)	P (kW)	(HP) KS
1	250	14	(19)	200	21	(28)
2	390	22	(30)	315	33	(45)
4	530	30	(40)	430	45	(61)
6	920	52	(70)	745	78	(106)
8	1500	85	(115)	1220	128	(174)

Table 1: Size, rotation speed, torque, power

2. WORKING ANGLE

The PTO drive shaft enables the transfer of torque between two shafts. The recommended working angle of a PTO drive shaft with single joints is up to 25 degrees. The PTO drive shaft with single joints can rotate also between the angles of 25 degrees till 40 degrees, but can transfer only 40% of the nominal torque of the PTO drive shaft.

A two sided wide-angle PTO drive shaft can operate up to an angle of 80 degrees. If the angle is exceeded PERMANENT DAMAGE of the joint or the whole PTO drive shaft is caused. With PTO drive shafts, where there is a single joint on one side and a wide-angle joint on the other, we need to take care, that the single joint does not exceed 15 degrees at 540 rotations per minute or 7 degrees at 1000 rotations per minute.



RECOMMENDED OPERATING ANGLES OF THE PTO DRIVE SHAFT/PTO DRIVE SHAFT TYPES
BR, BR+, PS, VS, VS1, ST, TS

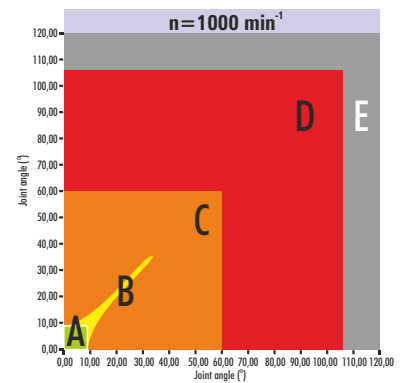
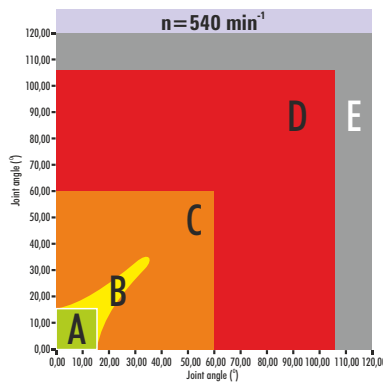

WIDEANGLE JOINT ON ONE SIDE

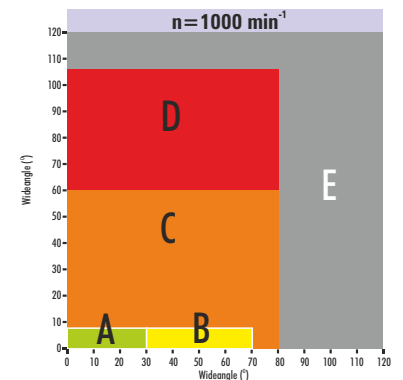
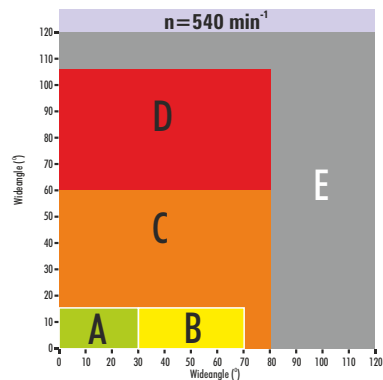



WIDEANGLE JOINT ON BOTH SIDES

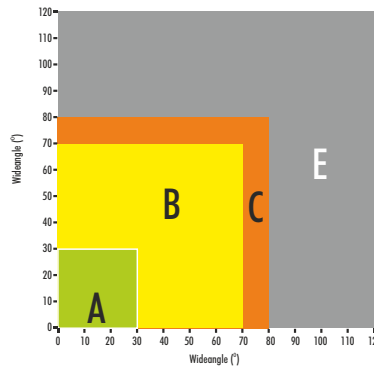

- **A** – Recommended operating range
- **B** – Allowed operating range
- **C** – Range in which the PTO drive shaft may rotate without torque transfer
- **D** – Range of allowed angle without rotating
- **E** – Range in which the breakage occurs

3. LENGTH OF THE PTO DRIVE SHAFT

Measure the minimum distance between the connecting shafts and deduct from this value the values given in the table below, with regard to the size and type of the desired PTO drive shaft. This results in the distance of PTO drive shaft **kk**.

In selecting the standard PTO drive shaft from the catalogue it is required to select the „kk“ value of which is smaller than the measured value.

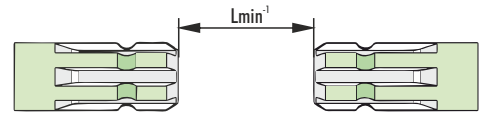

Size	Value to be deducted				
	BR, BR+	PS, PSL	VS	ST	TS
1	80	115	110	/	/
2	90	130	130	100	/
4	100	150	160	110	120
6	120	155	210	135	150
8	140	230	/	160	190

Example:

Measured value = 796
 Size of PTO drive shaft 4 Type of PTO drive shaft BR = 100
 Result = 696
 Selected standard length of PTO drive shaft **kk** = **kk660**

ARTICLE	DESCRIPTION	PTO DRIVE SHAFT OPERATING LENGHT		EAN 13 BAR CODE
		recommended L	maximum L	
005244	C Line 4 BR kk610 (840)	1055	1140	3831111014191
006680	C Line 4 BR kk660 (890)	1130	1240	3831111016362
006681	C Line 4 BR kk710 (940)	1205	1338	3831111016379

4. WORKING LENGTH OF THE PTO DRIVE SHAFT

When using the PTO drive shaft, the following values must be considered. The values are in millimeters.

	kk	510	560	610	660	710	760	810	860	910	960	1010	1110	1210	1310	1410
1	Lw	693	768	843	918	993	1068	1143	1218	1293	1368	1443	1593	1743	1893	2043
	Lt	740	837	920	1003	1087	1170	1253	1337	1420	1503	1587	1753	1920	2087	2253
	Ls	740	840	940	1040	1134	1221	1309	1396	1484	1571	1659	1834	2009	2184	2359
2	Lw	680	755	830	905	980	1055	1130	1205	1280	1355	1430	1580	1730	1880	2030
	Lt	730	820	903	987	1070	1153	1237	1320	1403	1487	1570	1737	1903	2070	2237
	Ls	730	830	930	1028	1115	1203	1290	1378	1465	1553	1640	1815	1990	2165	2340
4	Lw	675	750	825	900	975	1050	1125	1200	1275	1350	1425	1575	1725	1875	2025
	Lt	710	810	897	980	1063	1147	1230	1313	1397	1480	1563	1730	1897	2063	2230
	Ls	710	810	910	1010	1108	1195	1283	1370	1458	1545	1633	1808	1983	2158	2333
6	Lw	/	733	808	883	958	1033	1108	1183	1258	1333	1408	1558	1708	1858	2008
	Lt	/	775	873	957	1040	1123	1207	1290	1373	1457	1540	1707	1873	2040	2207
	Ls	/	775	875	975	1075	1169	1256	1344	1431	1519	1606	1781	1956	2131	2306
8	Lw	/	/	/	860	935	1010	1085	1160	1235	1315	1385	1535	1685	1835	1985
	Lt	/	/	/	920	1010	1093	1177	1260	1343	1433	1510	1677	1843	2010	2177
	Ls	/	/	/	920	1020	1120	1220	1310	1398	1493	1573	1748	1923	2098	2273

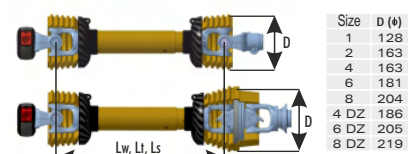

- kk** PTO drive shaft cross-cross distance
- Lw** Maximum work cross-cross length
- Lt** Maximum temporary cross-cross length
- Ls** Maximum cross-cross telescoping length without rotation

- Rotational frequency lower than 1000 min⁻¹
- Rotational frequency lower than 540 min⁻¹

5. SAFETY ELEMENT

Recommendations for the selection of the PTO drive shaft safety element:

	Clutch Type		
	VS	ST	TS
1 Appropriate for treatment of humus soil	● ● ●	● ● ● ● ●	● ● ● ● ● ●
2 Appropriate for treatment clayey soil	● ● ●	● ● ● ● ●	● ● ● ● ● ●
3 Appropriate for treatment of sandy soil	● ● ●	● ● ● ● ●	● ● ● ● ● ●
4 Appropriate for treatment of stony soil	● ● ●	●	● ● ●
5 Storage of grasses	● ● ● ● ●	● ● ●	● ● ●
6 Fruit farming and viticulture	● ● ● ● ●	●	●
7 Maintenance	● ● ● ● ●	● ● ●	● ● ●
8 Time to re-launch	● ● ● ● ●	●	● ● ● ● ● ●
9 User friendly	● ● ● ● ●	● ● ●	● ● ●

LESS APPROPRIATE 

APPROPRIATE 

RECOMMENDED 

6. THE MEANING OF CLUTCH CODES AND INTENDED PURPOSE



Overrunning clutch

PS "clockwise rotation, when the user is facing the PTO drive shaft towards the mover (tractor)"



Overrunning clutch

PSL "counter-clockwise rotation, when the user is facing the PTO drive shaft towards the mover (tractor)"

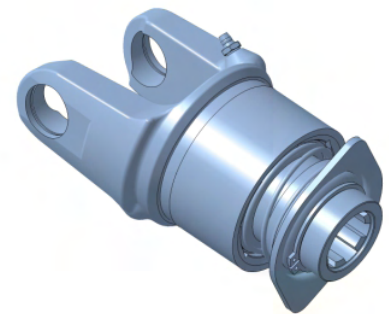

The overrunning clutch protects the mover (tractor) from loads due to inertial mass of the working machine. This clutch does not protect the machine from overloads. It is primarily intended for machines where greater masses rotate with large speed - rotors. These machines are primarily rotary mowers, flail mowers, etc. The overrunning clutch protects the tractor from traction energy of the inertial mass of the machine.

Before deciding, check if there is already an overrunning clutch installed in your machine.

A combination of PS + TS is also available on request.



Ratchet torque clutch

The ratchet torque clutch VS1 protects the machine from overloads. When the slip of the clutch occurs, it is required to stop the machine and to find out what caused the slip.

If the cause for slipping is due to overload of the machine, it is necessary to lower the load – to reduce the working speed...

When the clutch is activated the transferred lever to the machine is only as high as it is set. The excess of lever is not transmitted to the machine but eliminated through the clutch. When the clutch is being activated over a longer period of time it gets heated due to the elimination of the exceeded lever. Consecutive the springs get tired and the factory set nominal torque decreases. In this case you need

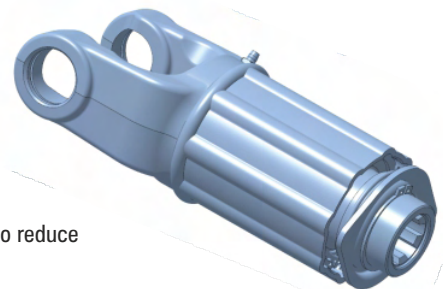

to carry out maintenance of your VS1 clutch at an authorized workshop, which has all the required tools at hand for a safe disassembly, reassembly and final check-up. (The disassembly of a VS clutch without the suitable tools can cause serious injuries due to the energy, which is set free from the prestressed springs - danger of flying objects!)

The nominal torque of the clutch is factory set, with a range from 300Nm to 1500Nm. They are used particularly for loading trailers, rakes and tedders, manure spreaders, maize pickers, etc.



Shear bolt torque clutch

The shear bolt clutch ST protects the machine from overloads. It is intended for machines without installed lever protection and which require an immediate stop of torque transfer. The shear bolt clutch limits the lever similar as the clutches VS, VS1 and TS, with the difference that the power transmission in case of exceeded lever is stopped at once (the bolt brakes) and the machine doesn't have transmission over the PTO drive shaft anymore. Afterwards you need to replace the shear bolt of equal strength class and size to continue with work.

Our patented clutch offers multiple options of nominal torque settings on one clutch and can be easily changed. Our clutch is more symmetrical, which affects the reduction of vibrations due to eccentric masses. Also changing the safety element is simplified due to the shape of the groove of the nut, which prevents the nut from rotating when screwing - only one spanner is needed for the change.

The range is from 900Nm to 3500Nm and depends on the size. They are predominantly used for machines intended for soil treatment, such as rotary milling cutters, rotary harrows, etc.

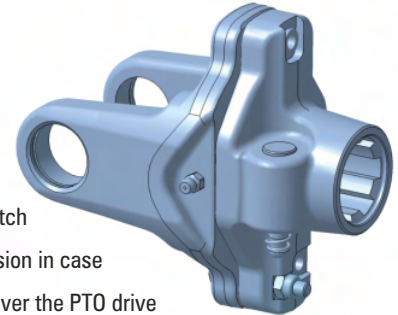

Friction torque clutch

The friction clutch TS protects the machine from overloads. There is no need to stop the torque transfer when the clutch slips. When the clutch is activated the transferred lever to the machine is only as high as it is set. The excess of lever is not transmitted to the machine but eliminated through the clutch. When the clutch is being activated over a longer period of time it gets heated due to the elimination of the exceeded lever. Consecutive the disks get tired and the factory set nominal torque decreases.

But we made maintenance easier - there are four holes on the friction clutch that allow the friction surface to be relieved before the season. The torque remains set in the meantime - it does not need to be readjusted. Due to the shape of the yoke adjustment is easier and more ergonomic. The yoke design holds the screw in place during adjustment and can be performed with just 1 spanner instead of two.

The nominal torque of the clutch is factory set, with a range from 800Nm to 2600Nm. The clutches are particularly used for rotary milling cutters, rotary harrows, etc.

A combination of PS + TS is also available on request.

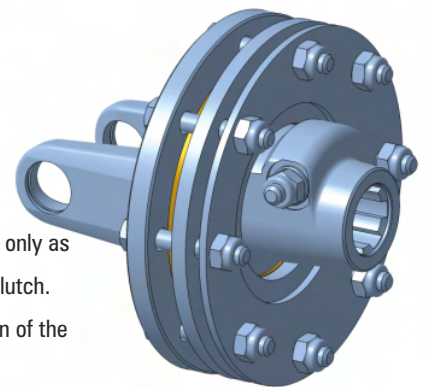

7. COUPLING PROFILE

The coupling shafts on tractors and machines are produced according to defined standard dimensions. Various machines require, because of their specific needs, various coupling profiles. That is why you need to correctly define the coupling profiles on both sides. Below you can see various coupling profiles. For couplings, which are not represented below, please send us an inquiry as we are able offer other coupling made to order.

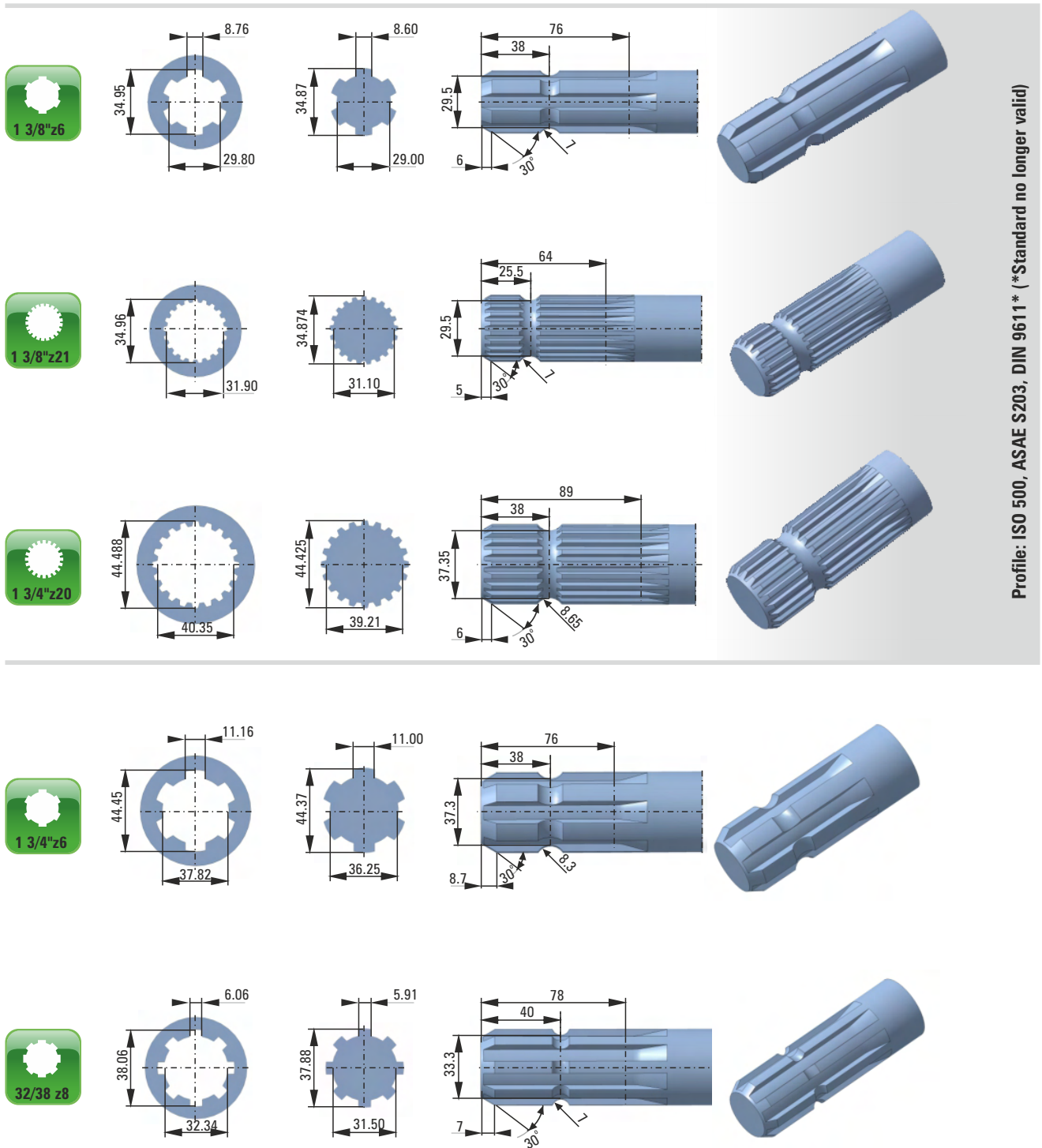

Profile: ISO 500, ASAE S203, DIN 9611* (*Standard no longer valid)



AVERAGE LIFESPAN

The endurance of the PTO drive shaft is usually connected to the lifespan of joint bearings, which depends on the torque, rotation speed and angle under which it operates.



The lower graph represents the principle for defining:

1. the size of PTO drive shaft (with regard to the expected lifespan, angle of operation, rotation speed, and torque)
2. the lifespan of PTO drive shaft (with regard to the size, torque, rotation speed, and operating angle)

Example 1: ←

Lifespan (hours)	500	500
Operating angle	(0 degrees)	(20 degrees)
Rotation speed	540 min ⁻¹	540 min ⁻¹
Torque	500 Nm	500 Nm
Appropriate size of PTO drive shaft		

Example 2: →

Size		
Torque	500 Nm	500 Nm
Rotation speed	540 min ⁻¹	540 min ⁻¹
Operating angle	(0 degrees)	(20 degrees)
Lifespan (hours)	3000	130

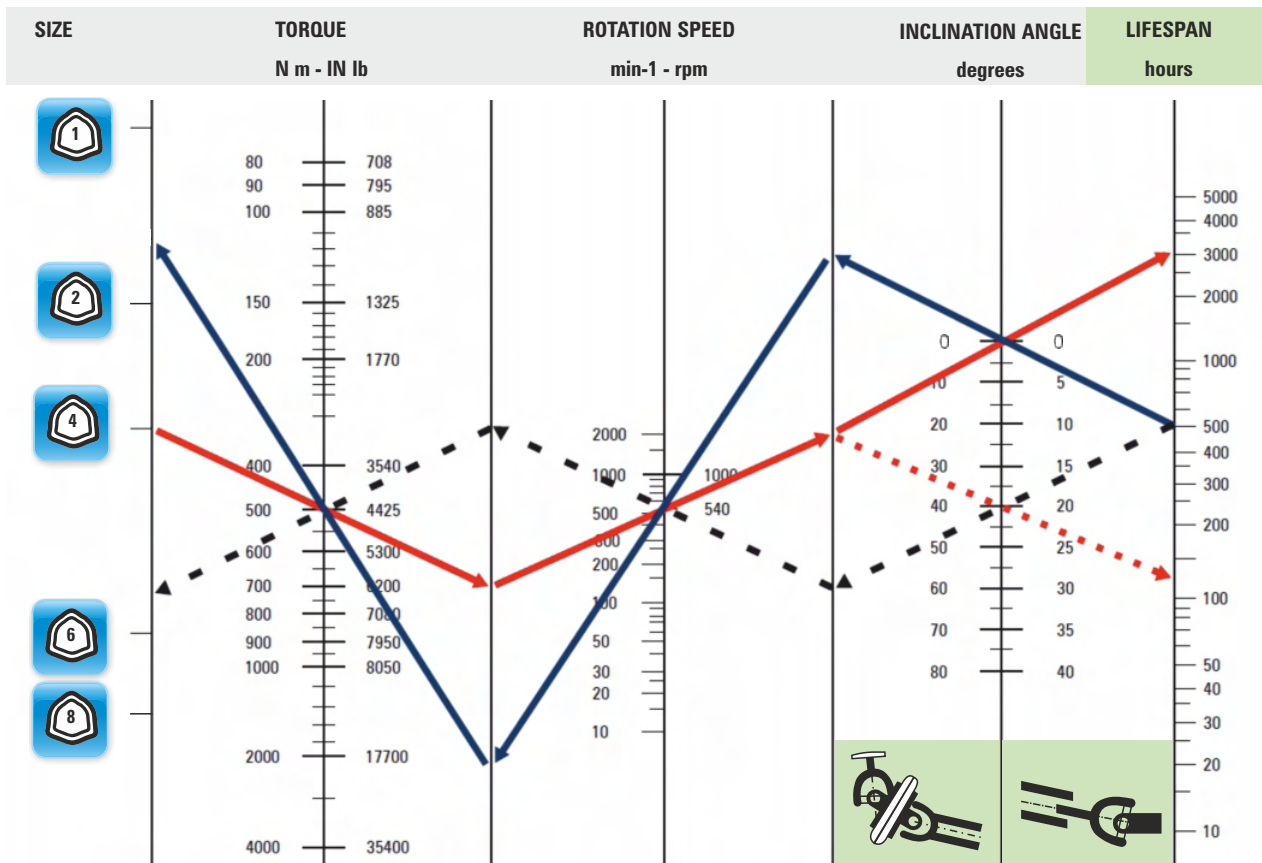



PTO DRIVE SHAFT C Line 1 BR+

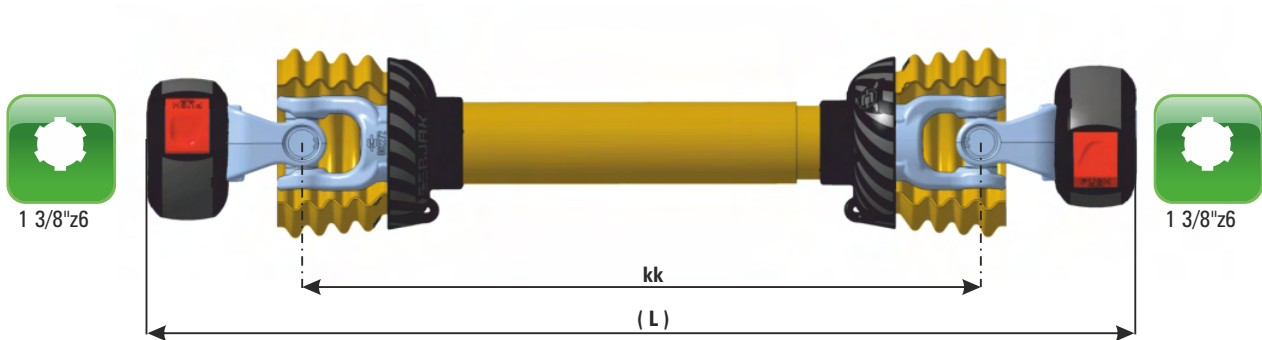

ARTICLE	DESCRIPTION	PTO DRIVE SHAFT OPERATING LENGHT		EAN 13 BAR CODE
		recommended L	maximum L	
007168	C Line 1 BR+ kk510 (720)	903	950	3831111020918
007170	C Line 1 BR+ kk560 (770)	978	1050	3831111020932
007171	C Line 1 BR+ kk610 (820)	1053	1150	3831111020949
007172	C Line 1 BR+ kk660 (870)	1128	1250	3831111020956
007173	C Line 1 BR+ kk710 (920)	1203	1344	3831111020963
007174	C Line 1 BR+ kk760 (970)	1278	1431	3831111020970
007175	C Line 1 BR+ kk810 (1020)	1353	1519	3831111020987
007176	C Line 1 BR+ kk860 (1070)	1428	1606	3831111020994
007177	C Line 1 BR+ kk910 (1120)	1503	1694	3831111021007
007178	C Line 1 BR+ kk960 (1170)	1578	1781	3831111021014
007179	C Line 1 BR+ kk1010 (1220)	1653	1869	3831111021021
007180	C Line 1 BR+ kk1110 (1320)	1803	2044	3831111021038
007181	C Line 1 BR+ kk1210 (1420)	1953	2219	3831111021045
007182	C Line 1 BR+ kk1310 (1520)	2103	2394	3831111021052
007183	C Line 1 BR+ kk1410 (1620)	2253	2569	3831111021069

PTO DRIVE SHAFT C Line 1 PS

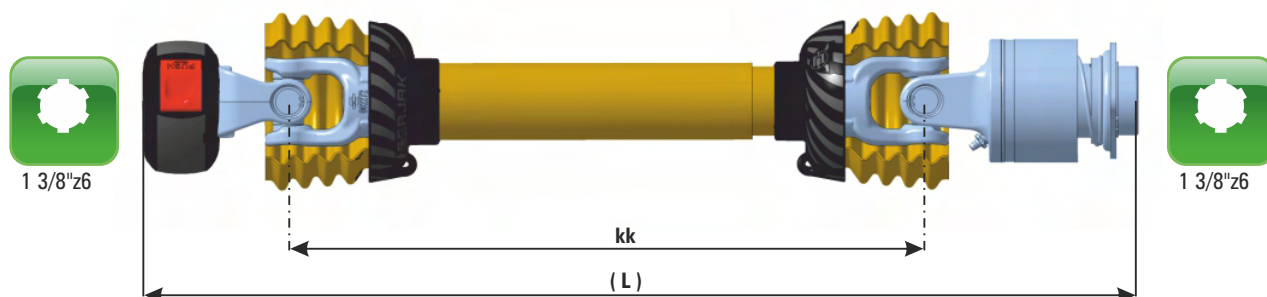

Limited availability

ARTICLE	DESCRIPTION	PTO DRIVE SHAFT OPERATING LENGHT		EAN 13 BAR CODE
		recommended L	maximum L	
006858	C Line 1 PS kk510 (760)	943	990	3831111018144 
006873	C Line 1 PS kk560 (810)	1018	1090	3831111018731 
006875	C Line 1 PS kk610 (860)	1093	1190	3831111018755 
006879	C Line 1 PS kk660 (910)	1168	1290	3831111018793 
006882	C Line 1 PS kk710 (960)	1243	1384	3831111018823 
006886	C Line 1 PS kk760 (1010)	1318	1471	3831111018861 
006889	C Line 1 PS kk810 (1060)	1393	1559	3831111018892 
006890	C Line 1 PS kk860 (1110)	1468	1646	3831111018908 
006891	C Line 1 PS kk910 (1160)	1543	1734	3831111019905 
006894	C Line 1 PS kk960 (1210)	1618	1821	3831111018939 
006895	C Line 1 PS kk1010 (1260)	1693	1909	3831111018946 
006897	C Line 1 PS kk1110 (1360)	1843	2084	3831111018953 
006899	C Line 1 PS kk1210 (1460)	1993	2259	3831111018977 
006902	C Line 1 PS kk1310 (1560)	2143	2434	3831111019004 
006905	C Line 1 PS kk1410 (1660)	2293	2609	3831111019035 

PTO DRIVE SHAFT C Line 1 PSL

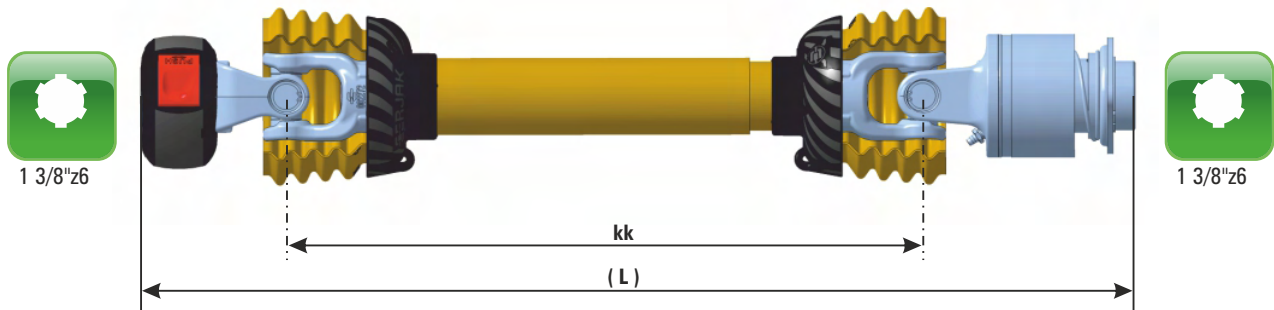

Limited availability

ARTICLE	DESCRIPTION	PTO DRIVE SHAFT OPERATING LENGHT		EAN 13 BAR CODE
		recommended L	maximum L	
006916	C Line 1 PSL kk510 (760)	943	990	3831111019141
006919	C Line 1 PSL kk560 (810)	1018	1090	3831111019172
006921	C Line 1 PSL kk610 (860)	1093	1190	3831111019196
006924	C Line 1 PSL kk660 (910)	1168	1290	3831111019226
006926	C Line 1 PSL kk710 (960)	1243	1384	3831111019240
006928	C Line 1 PSL kk760 (1010)	1318	1471	3831111019264
006930	C Line 1 PSL kk810 (1060)	1393	1559	3831111019288
006931	C Line 1 PSL kk860 (1110)	1468	1646	3831111019295
006934	C Line 1 PSL kk910 (1160)	1543	1734	3831111019912
006935	C Line 1 PSL kk960 (1210)	1618	1821	3831111019325
006938	C Line 1 PSL kk1010 (1260)	1693	1909	3831111019356
006941	C Line 1 PSL kk1110 (1360)	1843	2084	3831111019387
006943	C Line 1 PSL kk1210 (1460)	1993	2259	3831111019400
006945	C Line 1 PSL kk1310 (1560)	2143	2434	3831111019424
006946	C Line 1 PSL kk1410 (1660)	2293	2609	3831111019431

PTO DRIVE SHAFT

C Line 1 VS1 300Nm

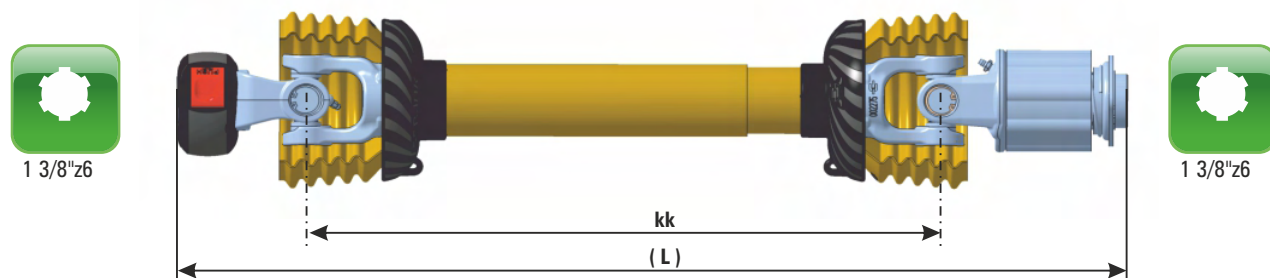

Limited availability

ARTICLE	DESCRIPTION	PTO DRIVE SHAFT OPERATING LENGHT		EAN 13 BAR CODE
		recommended L	maximum L	
006950	C Line 1 VS 300Nm kk510 (730)	913	960	3831111019479
006954	C Line 1 VS 300Nm kk560 (780)	988	1060	3831111019516
006957	C Line 1 VS 300Nm kk610 (830)	1063	1160	3831111019547
006959	C Line 1 VS 300Nm kk660 (880)	1138	1260	3831111019561
006978	C Line 1 VS 300Nm kk710 (930)	1213	1354	3831111019745
006980	C Line 1 VS 300Nm kk760 (980)	1288	1441	3831111019769
006982	C Line 1 VS 300Nm kk810 (1030)	1363	1529	3831111019783
006984	C Line 1 VS 300Nm kk860 (1080)	1438	1616	3831111019806
006986	C Line 1 VS 300Nm kk910 (1130)	1513	1704	3831111019936
006988	C Line 1 VS 300Nm kk960 (1180)	1588	1791	3831111019837
006989	C Line 1 VS 300Nm kk1010 (1230)	1663	1879	3831111019844
006990	C Line 1 VS 300Nm kk1110 (1330)	1813	2054	3831111019851
006991	C Line 1 VS 300Nm kk1210 (1430)	1963	2229	3831111019868
006992	C Line 1 VS 300Nm kk1310 (1530)	2113	2404	3831111019875
006993	C Line 1 VS 300Nm kk1410 (1630)	2263	2579	3831111019882

PTO DRIVE SHAFT C Line 1 VS1 450Nm

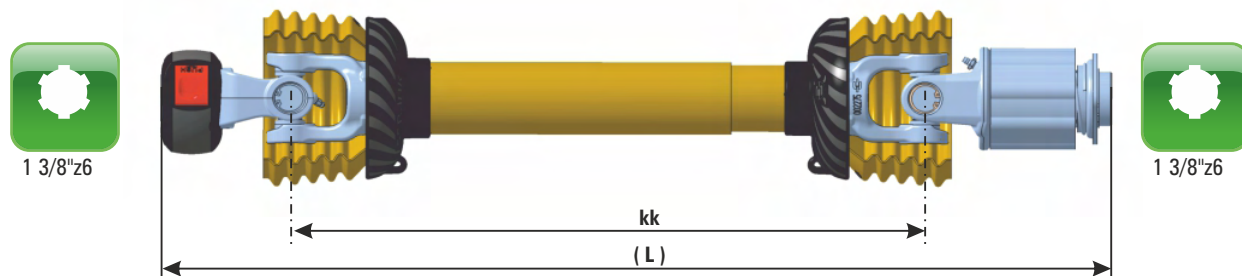

Limited availability

ARTICLE	DESCRIPTION	PTO DRIVE SHAFT OPERATING LENGHT		EAN 13 BAR CODE
		recommended L	maximum L	
006952	C Line 1 VS 450Nm kk510 (750)	933	980	3831111019493
006962	C Line 1 VS 450Nm kk560 (800)	1008	1080	3831111019592
006964	C Line 1 VS 450Nm kk610 (850)	1083	1180	3831111019615
006967	C Line 1 VS 450Nm kk660 (900)	1158	1280	3831111019646
006970	C Line 1 VS 450Nm kk710 (950)	1233	1374	3831111019677
006972	C Line 1 VS 450Nm kk760 (1000)	1308	1461	3831111019691
006974	C Line 1 VS 450Nm kk810 (1050)	1383	1549	3831111019714
006975	C Line 1 VS 450Nm kk860 (1100)	1458	1636	3831111019721
006976	C Line 1 VS 450Nm kk910 (1150)	1533	1724	3831111019929
006977	C Line 1 VS 450Nm kk960 (1200)	1608	1811	3831111019738
006979	C Line 1 VS 450Nm kk1010 (1250)	1683	1899	3831111019752
006981	C Line 1 VS 450Nm kk1110 (1350)	1833	2074	3831111019776
006983	C Line 1 VS 450Nm kk1210 (1450)	1983	2249	3831111019790
006985	C Line 1 VS 450Nm kk1310 (1550)	2133	2424	3831111019813
006987	C Line 1 VS 450Nm kk1410 (1650)	2283	2599	3831111019820

PTO DRIVE SHAFT

C Line 2 BR+

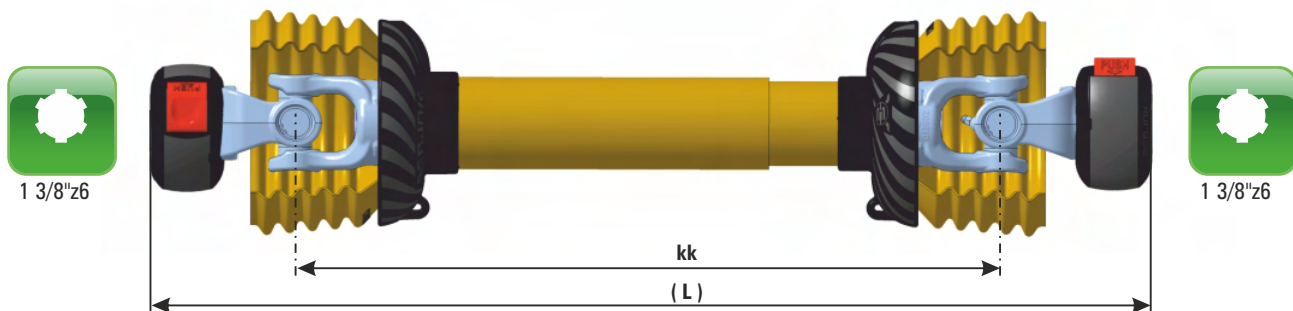

ARTICLE	DESCRIPTION	PTO DRIVE SHAFT OPERATING LENGHT		EAN 13 BAR CODE
		recommended L	maximum L	
018901	C Line 2 BR+ kk510 (730)	900	950	3831111096135
018902	C Line 2 BR+ kk560 (780)	970	1050	3831111096142
018904	C Line 2 BR+ kk610 (830)	1050	1150	3831111096166
018903	C Line 2 BR+ kk660 (880)	1120	1250	3831111096159
018740	C Line 2 BR+ kk710 (930)	1200	1330	3831111095527
018905	C Line 2 BR+ kk760 (980)	1270	1420	3831111096173
018906	C Line 2 BR+ kk810 (1030)	1350	1510	3831111096180
018907	C Line 2 BR+ kk860 (1080)	1420	1600	3831111096197
018908	C Line 2 BR+ kk910 (1130)	1500	1680	3831111096203
018909	C Line 2 BR+ kk960 (1180)	1570	1770	3831111096210
018910	C Line 2 BR+ kk1010 (1230)	1650	1860	3831111096227
018911	C Line 2 BR+ kk1110 (1330)	1800	2030	3831111096234
018912	C Line 2 BR+ kk1210 (1430)	1950	2210	3831111096241
018913	C Line 2 BR+ kk1310 (1530)	2100	2380	3831111096258
018914	C Line 2 BR+ kk1410 (1630)	2250	2560	3831111096265

PTO DRIVE SHAFT C Line 2 PS

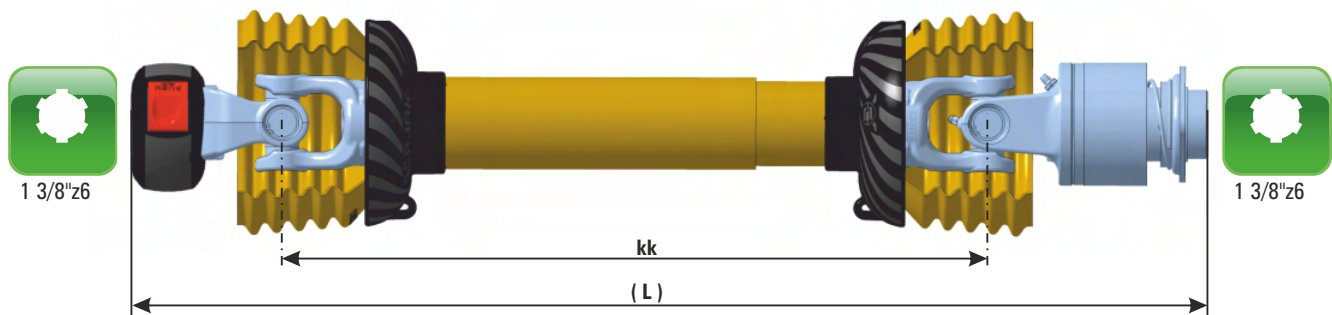

Limited availability

ARTICLE	DESCRIPTION	PTO DRIVE SHAFT OPERATING LENGHT		EAN 13 BAR CODE
		recommended L	maximum L	
018915	C Line 2 PS kk510 (760)	930	930	3831111096272
018916	C Line 2 PS kk560 (810)	1000	1000	3831111096289
018917	C Line 2 PS kk610 (860)	1080	1080	3831111096296
018918	C Line 2 PS kk660 (910)	1150	1150	3831111096302
018919	C Line 2 PS kk710 (960)	1230	1230	3831111096319
018920	C Line 2 PS kk760 (1010)	1300	1300	3831111096326
018921	C Line 2 PS kk810 (1060)	1380	1380	3831111096333
018922	C Line 2 PS kk860 (1110)	1450	1450	3831111096340
018760	C Line 2 PS kk910 (1160)	1530	1530	3831111095596
018923	C Line 2 PS kk960 (1210)	1600	1600	3831111096357
018924	C Line 2 PS kk1010 (1260)	1680	1680	3831111096364
018925	C Line 2 PS kk1110 (1360)	1830	1830	3831111096371
018926	C Line 2 PS kk1210 (1460)	1980	1980	3831111096388
018927	C Line 2 PS kk1310 (1560)	2130	2130	3831111096395
018928	C Line 2 PS kk1410 (1660)	2280	2280	3831111096401

PTO DRIVE SHAFT C Line 2 PSL

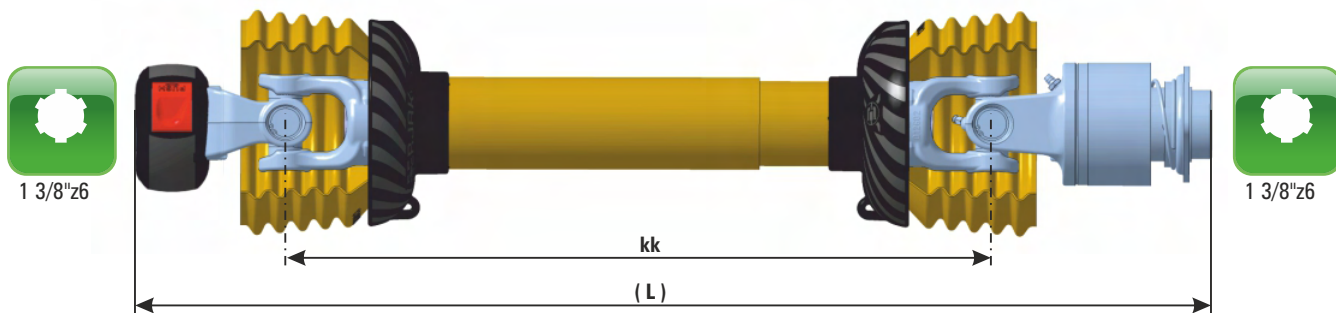

Limited availability

ARTICLE	DESCRIPTION	PTO DRIVE SHAFT OPERATING LENGHT		EAN 13 BAR CODE
		recommended L	maximum L	
018929	C Line 2 PSL kk510 (760)	930	930	3831111096418
018930	C Line 2 PSL kk560 (810)	1000	1000	3831111096425
018931	C Line 2 PSL kk610 (860)	1080	1080	3831111096432
018932	C Line 2 PSL kk660 (910)	1150	1150	3831111096449
018933	C Line 2 PSL kk710 (960)	1230	1230	3831111096456
018934	C Line 2 PSL kk760 (1010)	1300	1300	3831111096463
018935	C Line 2 PSL kk810 (1060)	1380	1380	3831111096470
018936	C Line 2 PSL kk860 (1110)	1450	1450	3831111096487
018767	C Line 2 PSL kk910 (1160)	1530	1530	3831111095640
018937	C Line 2 PSL kk960 (1210)	1600	1600	3831111096494
018938	C Line 2 PSL kk1010 (1260)	1680	1680	3831111096500
018939	C Line 2 PSL kk1110 (1360)	1830	1830	3831111096517
018940	C Line 2 PSL kk1210 (1460)	1980	1980	3831111096524
018941	C Line 2 PSL kk1310 (1560)	2130	2130	3831111096531
018942	C Line 2 PSL kk1410 (1660)	2280	2280	3831111096548

PTO DRIVE SHAFT C Line 2 VS1 450Nm



1 3/8"z6

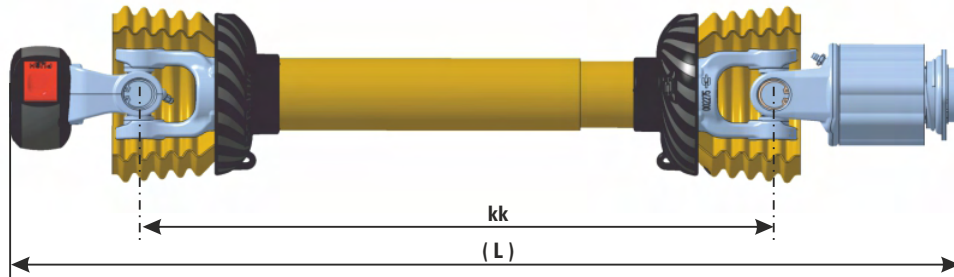

1 3/8"z6



Limited availability

ARTICLE	DESCRIPTION	PTO DRIVE SHAFT OPERATING LENGHT		EAN 13 BAR CODE
		recommended L	maximum L	
018943	C Line 2 VS 450Nm kk510 (760)	930	980	3831111096555
018944	C Line 2 VS 450Nm kk560 (810)	1000	1080	3831111096562
018945	C Line 2 VS 450Nm kk610 (860)	1080	1180	3831111096579
018946	C Line 2 VS 450Nm kk660 (910)	1150	1280	3831111096586
018947	C Line 2 VS 450Nm kk710 (960)	1230	1360	3831111096593
018948	C Line 2 VS 450Nm kk760 (1010)	1300	1450	3831111096609
018482	C Line 2 VS 450Nm kk810 (1060)	1380	1540	3831111094926
018951	C Line 2 VS 450Nm kk860 (1110)	1450	1630	3831111096616
018773	C Line 2 VS 450Nm kk910 (1160)	1530	1710	3831111095695
018952	C Line 2 VS 450Nm kk960 (1210)	1600	1800	3831111096623
018954	C Line 2 VS 450Nm kk1010 (1260)	1680	1890	3831111096630
018955	C Line 2 VS 450Nm kk1110 (1360)	1830	2060	3831111096647
018956	C Line 2 VS 450Nm kk1210 (1460)	1980	2240	3831111096654
018957	C Line 2 VS 450Nm kk1310 (1560)	2130	2410	3831111096661
018958	C Line 2 VS 450Nm kk1410 (1660)	2280	2590	3831111096678

PTO DRIVE SHAFT

C Line 2 VS1 600Nm

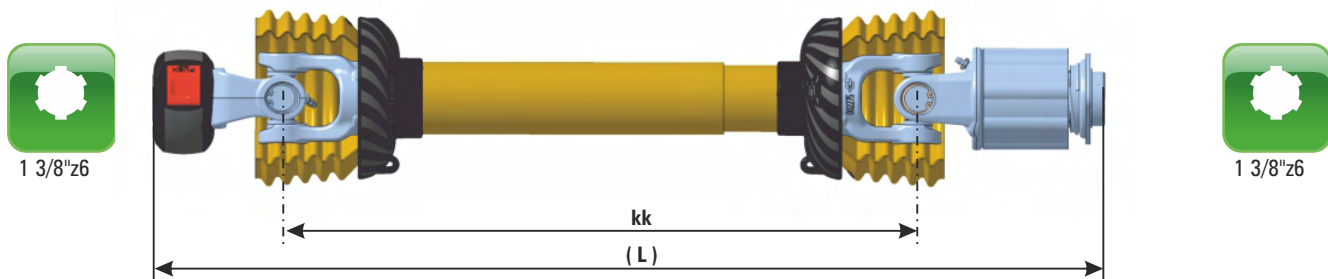

Limited availability

ARTICLE	DESCRIPTION	PTO DRIVE SHAFT OPERATING LENGHT		EAN 13 BAR CODE	
		recommended L	maximum L		
018959	C Line 2 VS 600Nm kk510 (760)	965	1000	3831111096685	
018960	C Line 2 VS 600Nm kk560 (810)	1040	1100	3831111096692	
018961	C Line 2 VS 600Nm kk610 (860)	1115	1200	3831111096708	
018962	C Line 2 VS 600Nm kk660 (910)	1190	1300	3831111096715	
018963	C Line 2 VS 600Nm kk710 (960)	1265	1398	3831111096722	
018965	C Line 2 VS 600Nm kk760 (1010)	1340	1485	3831111096739	
018966	C Line 2 VS 600Nm kk810 (1060)	1415	1573	3831111096746	
018967	C Line 2 VS 600Nm kk860 (1110)	1490	1660	3831111096753	
018774	C Line 2 VS 600Nm kk910 (1160)	1565	1748	3831111095701	
018968	C Line 2 VS 600Nm kk960 (1210)	1640	1835	3831111096760	
018969	C Line 2 VS 600Nm kk1010 (1260)	1715	1923	3831111096777	
018970	C Line 2 VS 600Nm kk1110 (1360)	1840	1990	3831111096784	
018971	C Line 2 VS 600Nm kk1210 (1460)	1990	2235	3831111096791	
018972	C Line 2 VS 600Nm kk1310 (1560)	2140	2410	3831111096807	
018973	C Line 2 VS 600Nm kk1410 (1660)	2290	2585	3831111096814	

PTO DRIVE SHAFT C Line 4 BR+

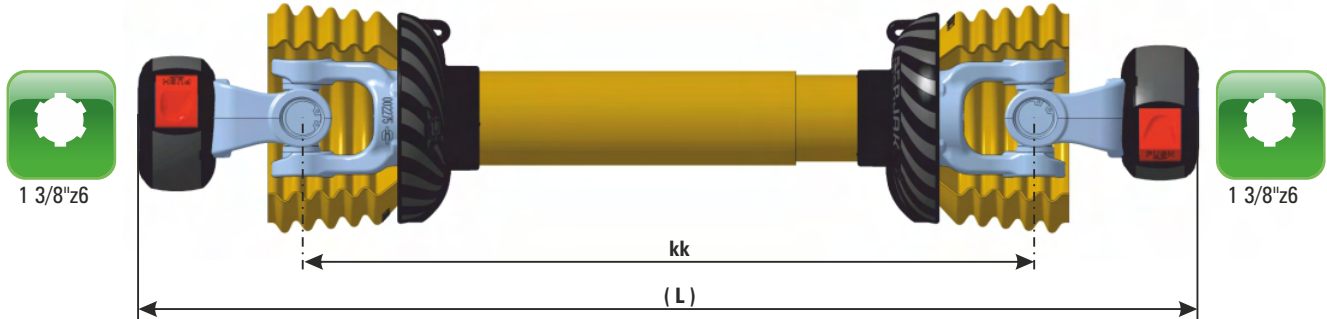

ARTICLE	DESCRIPTION	PTO DRIVE SHAFT OPERATING LENGHT		EAN 13 BAR CODE
		recommended L	maximum L	
007184	C Line 4 BR+ kk510 (740)	905	940	383111021076
007186	C Line 4 BR+ kk560 (790)	980	1040	383111021090
007187	C Line 4 BR+ kk610 (840)	1055	1140	383111021106
007188	C Line 4 BR+ kk660 (890)	1130	1240	383111021113
007189	C Line 4 BR+ kk710 (940)	1205	1338	383111021120
007190	C Line 4 BR+ kk760 (990)	1280	1425	383111021137
007191	C Line 4 BR+ kk810 (1040)	1355	1513	383111021144
007192	C Line 4 BR+ kk860 (1090)	1430	1600	383111021151
007193	C Line 4 BR+ kk910 (1140)	1505	1688	383111021168
007195	C Line 4 BR+ kk960 (1190)	1580	1775	383111021175
007197	C Line 4 BR+ kk1010 (1240)	1655	1863	383111021182
007198	C Line 4 BR+ kk1110 (1340)	1780	1930	383111021199
007200	C Line 4 BR+ kk1210 (1440)	1930	2175	383111021205
007201	C Line 4 BR+ kk1310 (1540)	2080	2350	383111021212
007204	C Line 4 BR+ kk1410 (1640)	2230	2525	383111021229

PTO DRIVE SHAFT C Line 4 PS

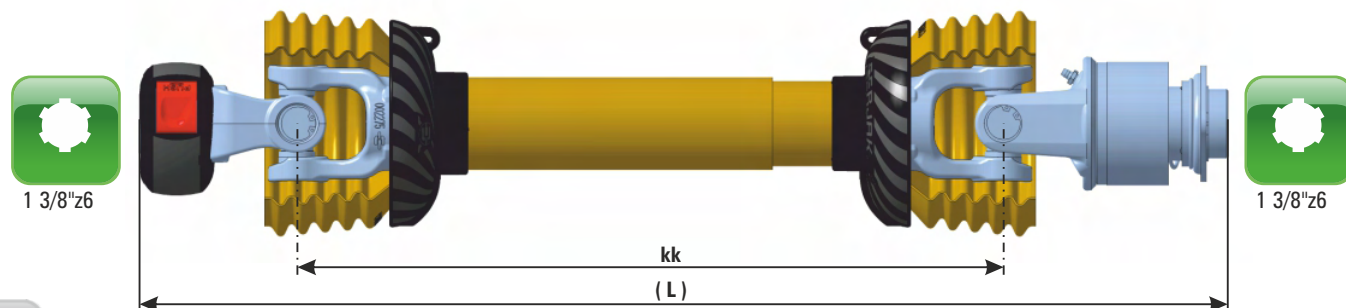

ARTICLE	DESCRIPTION	PTO DRIVE SHAFT OPERATING LENGHT		EAN 13 BAR CODE
		recommended L	maximum L	
006696	C Line 4 PS kk510 (790)	955	990	3831111016492
006697	C Line 4 PS kk560 (840)	1030	1090	3831111016508
005245	C Line 4 PS kk610 (890)	1105	1190	3831111014207
006698	C Line 4 PS kk660 (940)	1180	1290	3831111016553
006699	C Line 4 PS kk710 (990)	1255	1388	3831111016560
006700	C Line 4 PS kk760 (1040)	1330	1475	3831111016577
006702	C Line 4 PS kk810 (1090)	1405	1563	3831111016584
006703	C Line 4 PS kk860 (1140)	1480	1650	3831111016591
006704	C Line 4 PS kk910 (1190)	1555	1738	3831111016607
006705	C Line 4 PS kk960 (1240)	1630	1825	3831111016614
006706	C Line 4 PS kk1010 (1290)	1705	1913	3831111016621
006707	C Line 4 PS kk1110 (1390)	1830	1980	3831111016638
006708	C Line 4 PS kk1210 (1490)	1980	2225	3831111016645
006709	C Line 4 PS kk1310 (1590)	2130	2400	3831111016652
006710	C Line 4 PS kk1410 (1690)	2280	2575	3831111016669

*Possible PS + TS

PTO DRIVE SHAFT C Line 4 PSL

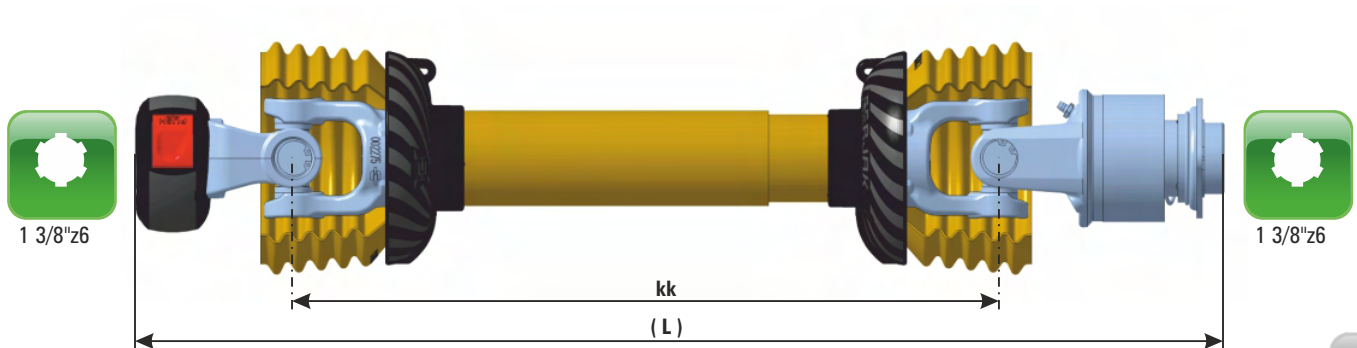

ARTICLE	DESCRIPTION	PTO DRIVE SHAFT OPERATING LENGHT		EAN 13 BAR CODE
		recommended L	maximum L	
006712	C Line 4 PSL kk510 (790)	955	990	383111016683
006713	C Line 4 PSL kk560 (840)	1030	1090	383111016690
006714	C Line 4 PSL kk610 (890)	1105	1190	383111016706
006715	C Line 4 PSL kk660 (940)	1180	1290	383111016713
006716	C Line 4 PSL kk710 (990)	1255	1388	383111016720
006717	C Line 4 PSL kk760 (1040)	1330	1475	383111016737
006718	C Line 4 PSL kk810 (1090)	1405	1563	383111016744
006719	C Line 4 PSL kk860 (1140)	1480	1650	383111016751
006720	C Line 4 PSL kk910 (1190)	1555	1738	383111016768
006721	C Line 4 PSL kk960 (1240)	1630	1825	383111016775
006722	C Line 4 PSL kk1010 (1290)	1705	1913	383111016782
006723	C Line 4 PSL kk1110 (1390)	1830	1980	383111016799
006724	C Line 4 PSL kk1210 (1490)	1980	2225	383111016805
006725	C Line 4 PSL kk1310 (1590)	2130	2400	383111016812
006726	C Line 4 PSL kk1410 (1690)	2280	2575	383111016829

PTO DRIVE SHAFT

C Line 4 VS1 600Nm

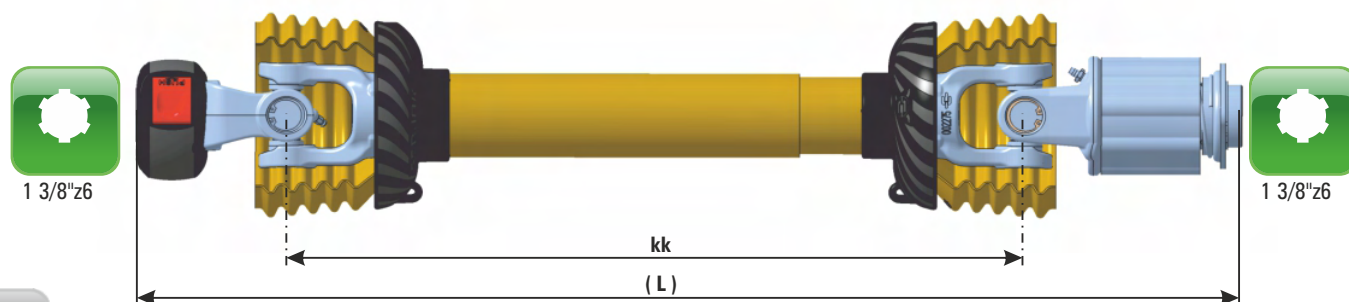

ARTICLE	DESCRIPTION	PTO DRIVE SHAFT OPERATING LENGHT		EAN 13 BAR CODE	EAN 13 BAR CODE
		recommended L	maximum L		
006728	C Line 4 VS 600Nm kk510 (780)	945	980	3831111016843	
006729	C Line 4 VS 600Nm kk560 (830)	1020	1080	3831111016850	
006730	C Line 4 VS 600Nm kk610 (880)	1095	1180	3831111016867	
006731	C Line 4 VS 600Nm kk660 (930)	1170	1280	3831111016874	
006732	C Line 4 VS 600Nm kk710 (980)	1245	1378	3831111016881	
006733	C Line 4 VS 600Nm kk760 (1030)	1320	1465	3831111016898	
006734	C Line 4 VS 600Nm kk810 (1080)	1395	1553	3831111016904	
006735	C Line 4 VS 600Nm kk860 (1130)	1470	1640	3831111016911	
006736	C Line 4 VS 600Nm kk910 (1180)	1545	1728	3831111016928	
006737	C Line 4 VS 600Nm kk960 (1230)	1620	1815	3831111016935	
006738	C Line 4 VS 600Nm kk1010 (1280)	1695	1903	3831111016942	
006739	C Line 4 VS 600Nm kk1110 (1380)	1820	1970	3831111016959	
006740	C Line 4 VS 600Nm kk1210 (1480)	1970	2215	3831111016966	
006741	C Line 4 VS 600Nm kk1310 (1580)	2120	2390	3831111016973	
006742	C Line 4 VS 600Nm kk1410 (1680)	2270	2565	3831111016980	

PTO DRIVE SHAFT C Line 4 VS1 900Nm

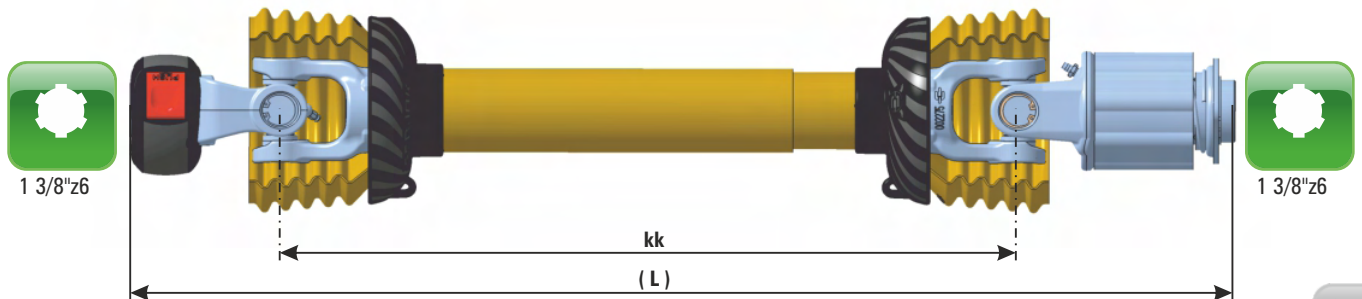

ARTICLE	DESCRIPTION	PTO DRIVE SHAFT OPERATING LENGHT		EAN 13 BAR CODE
		recommended L	maximum L	
006744	C Line 4 VS 900Nm kk510 (800)	965	1000	3831111017024
006745	C Line 4 VS 900Nm kk560 (850)	1040	1100	3831111017031
006746	C Line 4 VS 900Nm kk610 (900)	1115	1200	3831111017048
006747	C Line 4 VS 900Nm kk660 (950)	1190	1300	3831111017055
006748	C Line 4 VS 900Nm kk710 (1000)	1265	1398	3831111017062
006749	C Line 4 VS 900Nm kk760 (1050)	1340	1485	3831111017079
006750	C Line 4 VS 900Nm kk810 (1100)	1415	1573	3831111017086
006751	C Line 4 VS 900Nm kk860 (1150)	1490	1660	3831111017093
006752	C Line 4 VS 900Nm kk910 (1200)	1565	1748	3831111017109
006753	C Line 4 VS 900Nm kk960 (1250)	1640	1835	3831111017116
006754	C Line 4 VS 900Nm kk1010 (1300)	1715	1923	3831111017123
006755	C Line 4 VS 900Nm kk1110 (1400)	1840	1990	3831111017130
006756	C Line 4 VS 900Nm kk1210 (1500)	1990	2235	3831111017147
006757	C Line 4 VS 900Nm kk1310 (1600)	2140	2410	3831111017154
006758	C Line 4 VS 900Nm kk1410 (1700)	2290	2585	3831111017161

PTO DRIVE SHAFT C Line 4 ST 900Nm

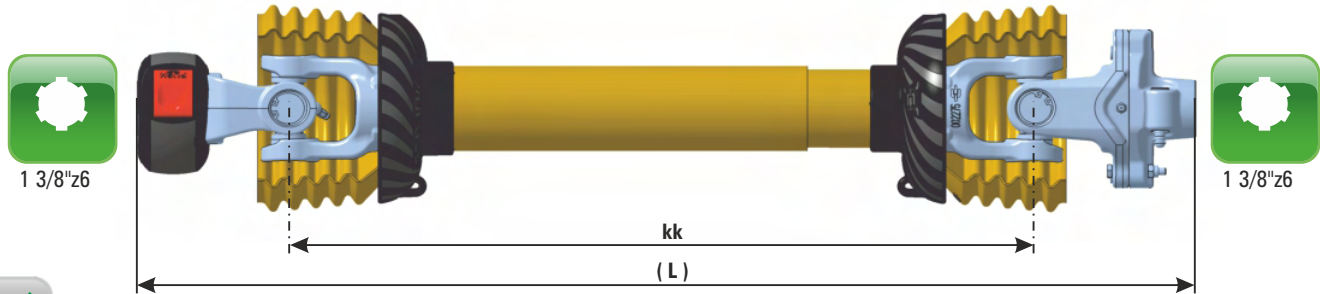

ARTICLE	DESCRIPTION	PTO DRIVE SHAFT OPERATING LENGHT		EAN 13 BAR CODE	
		recommended L	maximum L		
006760	C Line 4 ST 900Nm kk510 (740)	905	940	3831111017185	
006761	C Line 4 ST 900Nm kk560 (790)	980	1040	3831111017192	
006762	C Line 4 ST 900Nm kk610 (840)	1055	1140	3831111017208	
006763	C Line 4 ST 900Nm kk660 (890)	1130	1240	3831111017215	
006764	C Line 4 ST 900Nm kk710 (940)	1205	1338	3831111017222	
006765	C Line 4 ST 900Nm kk760 (990)	1280	1425	3831111017239	
006766	C Line 4 ST 900Nm kk810 (1040)	1355	1513	3831111017246	
006767	C Line 4 ST 900Nm kk860 (1090)	1430	1600	3831111017253	
006768	C Line 4 ST 900Nm kk910 (1140)	1505	1688	3831111017260	
006769	C Line 4 ST 900Nm kk960 (1190)	1580	1775	3831111017277	
006770	C Line 4 ST 900Nm kk1010 (1240)	1655	1863	3831111017284	
006771	C Line 4 ST 900Nm kk1110 (1340)	1780	1930	3831111017291	
006772	C Line 4 ST 900Nm kk1210 (1440)	1930	2175	3831111017307	
006773	C Line 4 ST 900Nm kk1310 (1540)	2080	2350	3831111017314	
006774	C Line 4 ST 900Nm kk1410 (1640)	2230	2525	3831111017321	

PTO DRIVE SHAFT C Line 4 ST 1300Nm

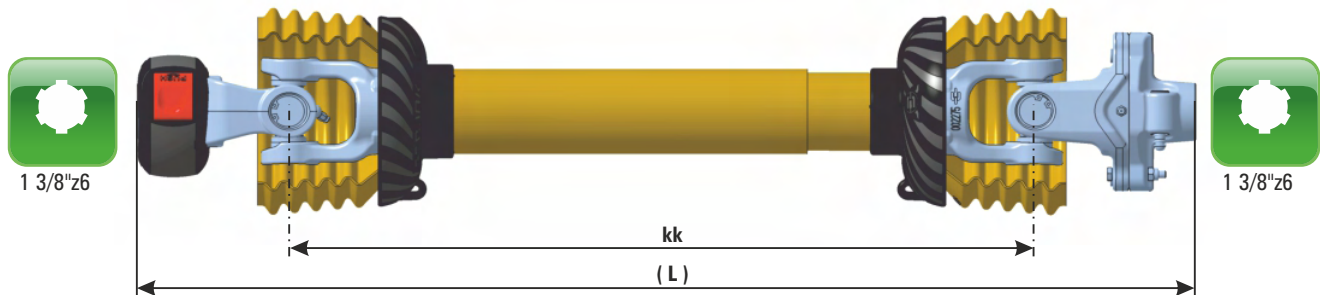

ARTICLE	DESCRIPTION	PTO DRIVE SHAFT OPERATING LENGHT		EAN 13 BAR CODE
		recommended L	maximum L	
028279	C Line 4 ST 1300Nm kk510 (740)	905	940	3838433013772
028280	C Line 4 ST 1300Nm kk560 (790)	980	1040	3838433013789
028281	C Line 4 ST 1300Nm kk610 (840)	1055	1140	3838433013796
028282	C Line 4 ST 1300Nm kk660 (890)	1130	1240	3838433013802
024290	C Line 4 ST 1300Nm kk710 (940)	1205	1338	3838433008716
028283	C Line 4 ST 1300Nm kk760 (990)	1280	1425	3838433013819
028284	C Line 4 ST 1300Nm kk810 (1040)	1355	1513	3838433013826
028285	C Line 4 ST 1300Nm kk860 (1090)	1430	1600	3838433013833
028286	C Line 4 ST 1300Nm kk910 (1140)	1505	1688	3838433013840
028287	C Line 4 ST 1300Nm kk960 (1190)	1580	1775	3838433013857
028288	C Line 4 ST 1300Nm kk1010 (1240)	1655	1863	3838433013864
028289	C Line 4 ST 1300Nm kk1110 (1340)	1780	1930	3838433013871
028290	C Line 4 ST 1300Nm kk1210 (1440)	1930	2175	3838433013888
028291	C Line 4 ST 1300Nm kk1310 (1540)	2080	2350	3838433013895
028292	C Line 4 ST 1300Nm kk1410 (1640)	2230	2525	3838433013901

PTO DRIVE SHAFT

C Line 4 ST 1700Nm

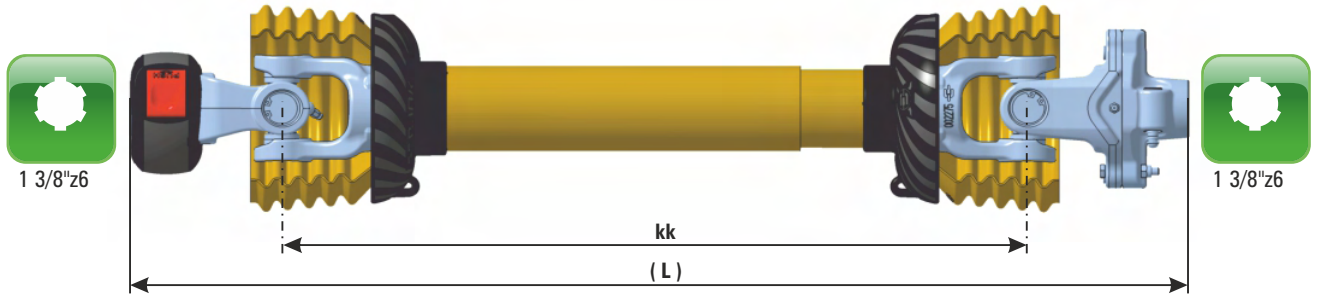

ARTICLE	DESCRIPTION	PTO DRIVE SHAFT OPERATING LENGHT		EAN 13 BAR CODE
		recommended L	maximum L	
006778	C Line 4 ST 1700Nm kk510 (740)	905	940	3831111017352
006779	C Line 4 ST 1700Nm kk560 (790)	980	1040	3831111017369
006780	C Line 4 ST 1700Nm kk610 (840)	1055	1140	3831111017376
006781	C Line 4 ST 1700Nm kk660 (890)	1130	1240	3831111017383
006783	C Line 4 ST 1700Nm kk710 (940)	1205	1338	3831111017413
006784	C Line 4 ST 1700Nm kk760 (990)	1280	1425	3831111017420
006785	C Line 4 ST 1700Nm kk810 (1040)	1355	1513	3831111017437
006787	C Line 4 ST 1700Nm kk860 (1090)	1430	1600	3831111017444
006788	C Line 4 ST 1700Nm kk910 (1140)	1505	1688	3831111017451
006789	C Line 4 ST 1700Nm kk960 (1190)	1580	1775	3831111017468
006790	C Line 4 ST 1700Nm kk1010 (1240)	1655	1863	3831111017475
006791	C Line 4 ST 1700Nm kk1110 (1340)	1780	1930	3831111017482
006792	C Line 4 ST 1700Nm kk1210 (1440)	1930	2175	3831111017499
006794	C Line 4 ST 1700Nm kk1310 (1540)	2080	2350	3831111017505
006796	C Line 4 ST 1700Nm kk1410 (1640)	2230	2525	3831111017512

PTO DRIVE SHAFT C Line 4 TS 800Nm

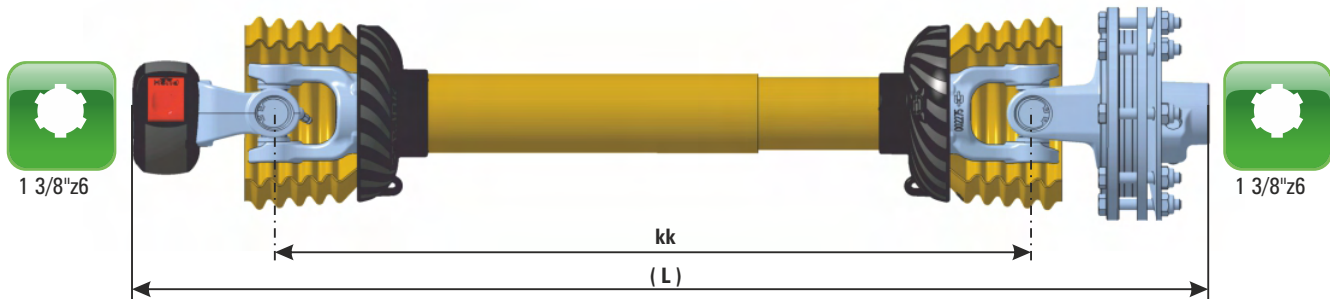

ARTICLE	DESCRIPTION	PTO DRIVE SHAFT OPERATING LENGHT		EAN 13 BAR CODE
		recommended L	maximum L	
006800	C Line 4 TS 800Nm kk510 (760)	925	960	3831111017536
006802	C Line 4 TS 800Nm kk560 (810)	1000	1060	3831111017550
006803	C Line 4 TS 800Nm kk610 (860)	1075	1160	3831111017567
006804	C Line 4 TS 800Nm kk660 (910)	1150	1260	3831111017574
006805	C Line 4 TS 800Nm kk710 (960)	1225	1358	3831111017581
006807	C Line 4 TS 800Nm kk760 (1010)	1300	1445	3831111017604
006808	C Line 4 TS 800Nm kk810 (1060)	1375	1533	3831111017611
006811	C Line 4 TS 800Nm kk860 (1110)	1450	1620	3831111017642
006812	C Line 4 TS 800Nm kk910 (1160)	1525	1708	3831111017659
006813	C Line 4 TS 800Nm kk960 (1210)	1600	1795	3831111017666
006815	C Line 4 TS 800Nm kk1010 (1260)	1675	1883	3831111017697
006816	C Line 4 TS 800Nm kk1110 (1360)	1800	1950	3831111017703
006818	C Line 4 TS 800Nm kk1210 (1460)	1950	2195	3831111017727
006819	C Line 4 TS 800Nm kk1310 (1560)	2100	2370	3831111017734
006820	C Line 4 TS 800Nm kk1410 (1660)	2250	2545	3831111017741

*Possible PS + TS

PTO DRIVE SHAFT C Line 6 BR+

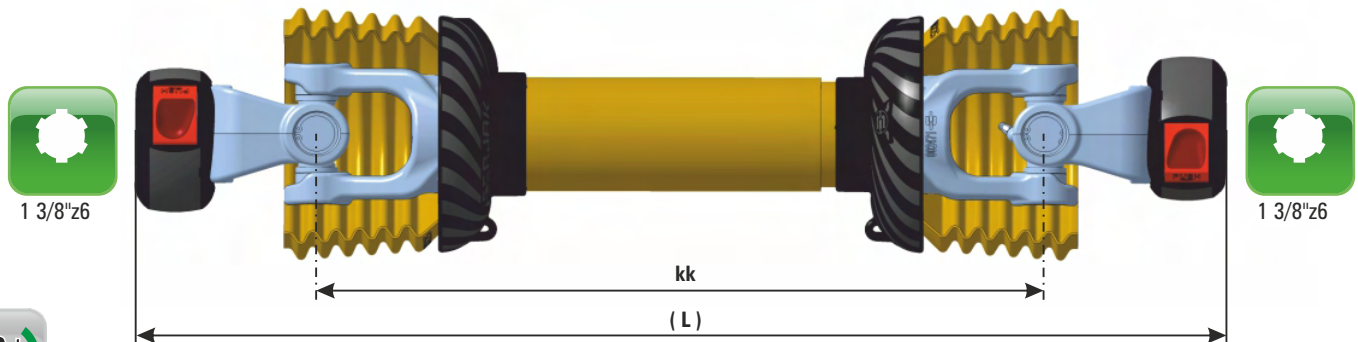

ARTICLE	DESCRIPTION	PTO DRIVE SHAFT OPERATING LENGHT		EAN 13 BAR CODE	
		recommended L	maximum L		
007205	C Line 6 BR+ kk560 (820)	993	1035	3831111021236	
007207	C Line 6 BR+ kk610 (870)	1068	1135	3831111021250	
007208	C Line 6 BR+ kk660 (920)	1143	1235	3831111021267	
007209	C Line 6 BR+ kk710 (970)	1218	1335	3831111021274	
007210	C Line 6 BR+ kk760 (1020)	1293	1429	3831111021281	
007211	C Line 6 BR+ kk810 (1070)	1368	1516	3831111021298	
007213	C Line 6 BR+ kk860 (1120)	1443	1604	3831111021304	
007214	C Line 6 BR+ kk910 (1170)	1518	1691	3831111021311	
007217	C Line 6 BR+ kk960 (1220)	1593	1779	3831111021328	
007219	C Line 6 BR+ kk1010 (1270)	1668	1866	3831111021335	
007220	C Line 6 BR+ kk1110 (1370)	1793	2004	3831111021342	
007221	C Line 6 BR+ kk1210 (1470)	1918	2141	3831111021359	
007222	C Line 6 BR+ kk1310 (1570)	2043	2279	3831111021366	
007223	C Line 6 BR+ kk1410 (1670)	2168	2416	3831111021373	

PTO DRIVE SHAFT C Line 6 PS

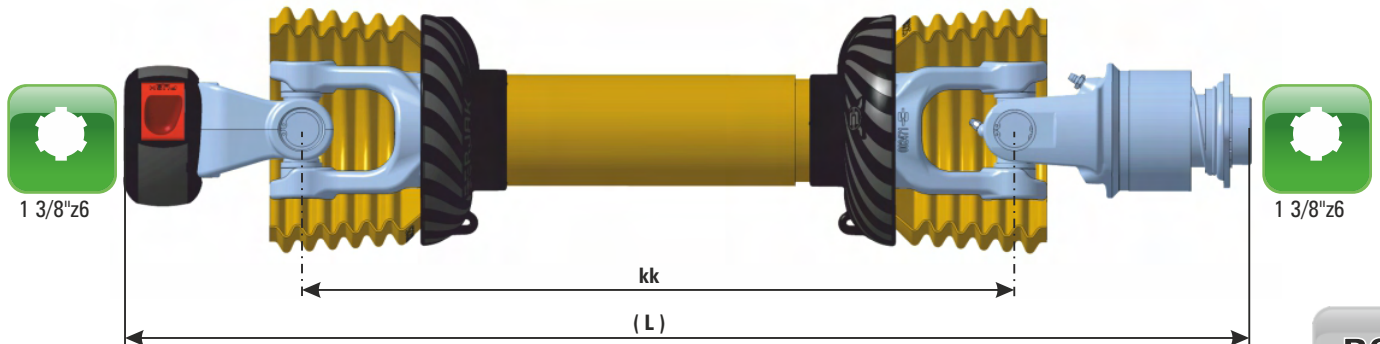

ARTICLE	DESCRIPTION	PTO DRIVE SHAFT OPERATING LENGHT		EAN 13 BAR CODE
		recommended L	maximum L	
006835	C Line 6 PS kk560 (860)	1033	1075	3831111017901
006836	C Line 6 PS kk610 (910)	1108	1175	3831111017918
006837	C Line 6 PS kk660 (960)	1183	1275	3831111017925
006839	C Line 6 PS kk710 (1010)	1258	1375	3831111017949
006851	C Line 6 PS kk760 (1060)	1333	1469	3831111018076
006852	C Line 6 PS kk810 (1110)	1408	1556	3831111018083
006853	C Line 6 PS kk860 (1160)	1483	1644	3831111018090
006854	C Line 6 PS kk910 (1210)	1558	1731	3831111018106
006855	C Line 6 PS kk960 (1260)	1633	1819	3831111018113
006856	C Line 6 PS kk1010 (1310)	1708	1906	3831111018120
006857	C Line 6 PS kk1110 (1410)	1833	2044	3831111018137
006859	C Line 6 PS kk1210 (1510)	1958	2181	3831111018151
006860	C Line 6 PS kk1310 (1610)	2083	2319	3831111018168
006861	C Line 6 PS kk1410 (1710)	2208	2456	3831111018618

*Possible PS + TS

PTO DRIVE SHAFT C Line 6 PSL

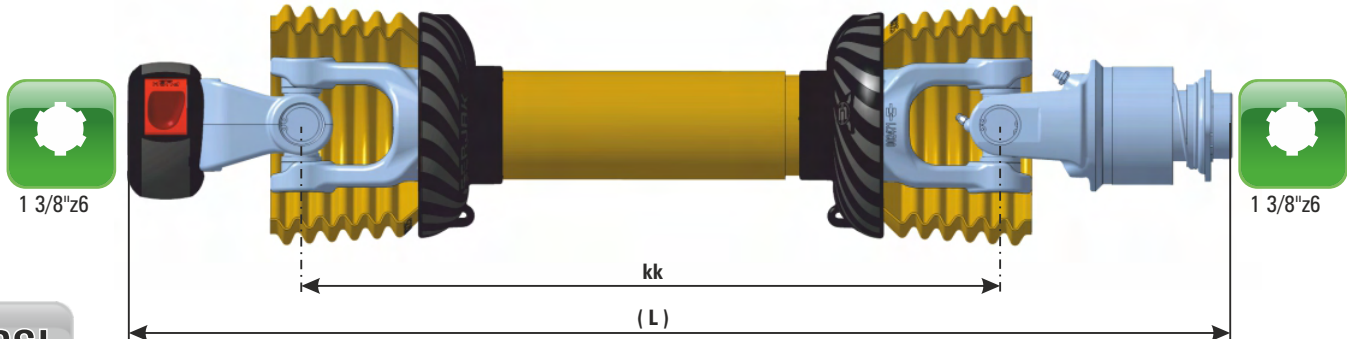

ARTICLE	DESCRIPTION	PTO DRIVE SHAFT OPERATING LENGHT		EAN 13 BAR CODE	
		recommended L	maximum L		
006864	C Line 6 PSL kk560 (860)	1033	1075	3831111018649	
006867	C Line 6 PSL kk610 (910)	1108	1175	3831111018670	
006868	C Line 6 PSL kk660 (960)	1183	1275	3831111018687	
006870	C Line 6 PSL kk710 (1010)	1258	1375	3831111018700	
006872	C Line 6 PSL kk760 (1060)	1333	1469	3831111018724	
006876	C Line 6 PSL kk810 (1110)	1408	1556	3831111018762	
006878	C Line 6 PSL kk860 (1160)	1483	1644	3831111018786	
006881	C Line 6 PSL kk910 (1210)	1558	1731	3831111018816	
006883	C Line 6 PSL kk960 (1260)	1633	1819	3831111018830	
006885	C Line 6 PSL kk1010 (1310)	1708	1906	3831111018854	
006887	C Line 6 PSL kk1110 (1410)	1833	2044	3831111018878	
006888	C Line 6 PSL kk1210 (1510)	1958	2181	3831111018885	
006892	C Line 6 PSL kk1310 (1610)	2083	2319	3831111018915	
006893	C Line 6 PSL kk1410 (1710)	2208	2456	3831111018922	

PTO DRIVE SHAFT C Line 6 VS1 1200Nm

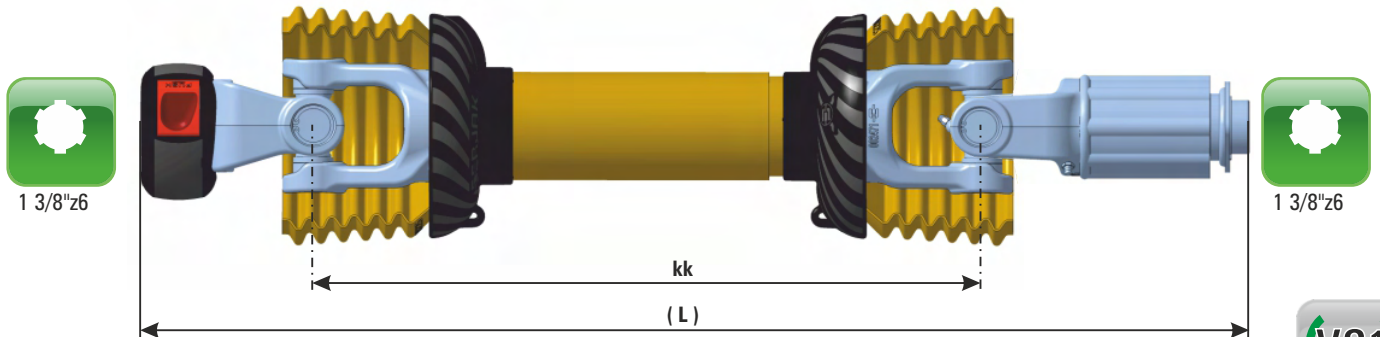

ARTICLE	DESCRIPTION	PTO DRIVE SHAFT OPERATING LENGHT		EAN 13 BAR CODE
		recommended L	maximum L	
006845	C Line 6 VS1 1200Nm kk560 (890)	1063	1105	3831111018014
006846	C Line 6 VS1 1200Nm kk610 (940)	1138	1205	3831111018021
006847	C Line 6 VS1 1200Nm kk660 (990)	1213	1305	3831111018038
006848	C Line 6 VS1 1200Nm kk710 (1040)	1288	1405	3831111018045
006849	C Line 6 VS1 1200Nm kk760 (1090)	1363	1499	3831111018052
006850	C Line 6 VS1 1200Nm kk810 (1140)	1438	1586	3831111018069
006863	C Line 6 VS1 1200Nm kk860 (1190)	1513	1674	3831111018632
006866	C Line 6 VS1 1200Nm kk910 (1240)	1588	1761	3831111018663
006869	C Line 6 VS1 1200Nm kk960 (1290)	1663	1849	3831111018694
006871	C Line 6 VS1 1200Nm kk1010 (1340)	1738	1936	3831111018717
006874	C Line 6 VS1 1200Nm kk1110 (1440)	1863	2074	3831111018748
006877	C Line 6 VS1 1200Nm kk1210 (1540)	1988	2211	3831111018779
006880	C Line 6 VS1 1200Nm kk1310 (1640)	2113	2349	3831111018809
006884	C Line 6 VS1 1200Nm kk1410 (1740)	2238	2486	3831111018847

PTO DRIVE SHAFT

C Line 6 VS1 1500Nm

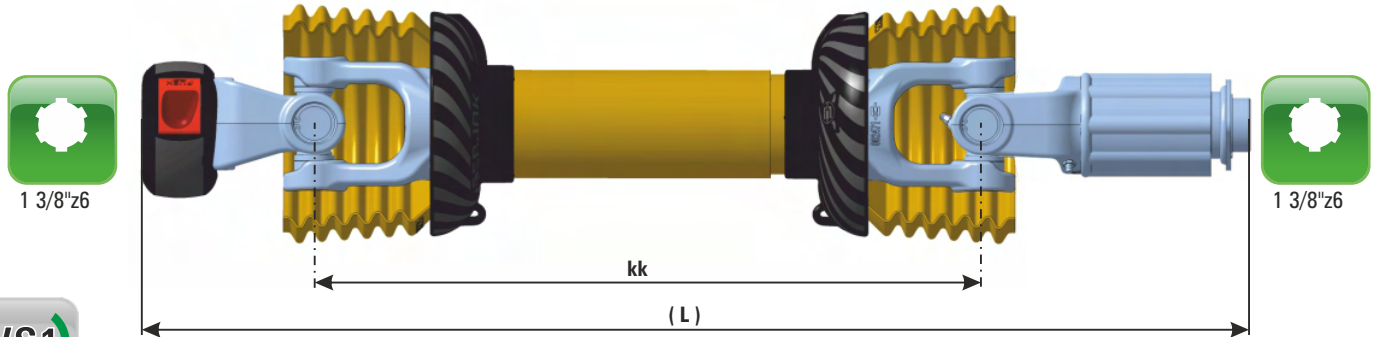

ARTICLE	DESCRIPTION	PTO DRIVE SHAFT OPERATING LENGHT		EAN 13 BAR CODE
		recommended L	maximum L	
006901	C Line 6 VS1 1500Nm kk560 (910)	1083	1125	3831111018991
006904	C Line 6 VS1 1500Nm kk610 (960)	1158	1225	3831111019028
006906	C Line 6 VS1 1500Nm kk660 (1010)	1233	1325	3831111019042
006908	C Line 6 VS1 1500Nm kk710 (1060)	1308	1425	3831111019066
006910	C Line 6 VS1 1500Nm kk760 (1110)	1383	1519	3831111019080
006913	C Line 6 VS1 1500Nm kk810 (1160)	1458	1606	3831111019110
006915	C Line 6 VS1 1500Nm kk860 (1210)	1533	1694	3831111019134
006918	C Line 6 VS1 1500Nm kk910 (1260)	1608	1781	3831111019165
006922	C Line 6 VS1 1500Nm kk960 (1310)	1683	1869	3831111019202
006927	C Line 6 VS1 1500Nm kk1010 (1360)	1758	1956	3831111019257
006932	C Line 6 VS1 1500Nm kk1110 (1460)	1883	2094	3831111019301
006937	C Line 6 VS1 1500Nm kk1210 (1560)	2008	2231	3831111019349
006940	C Line 6 VS1 1500Nm kk1310 (1660)	2133	2369	3831111019370
006942	C Line 6 VS1 1500Nm kk1410 (1760)	2258	2506	3831111019394

PTO DRIVE SHAFT C Line 6 ST 1700Nm

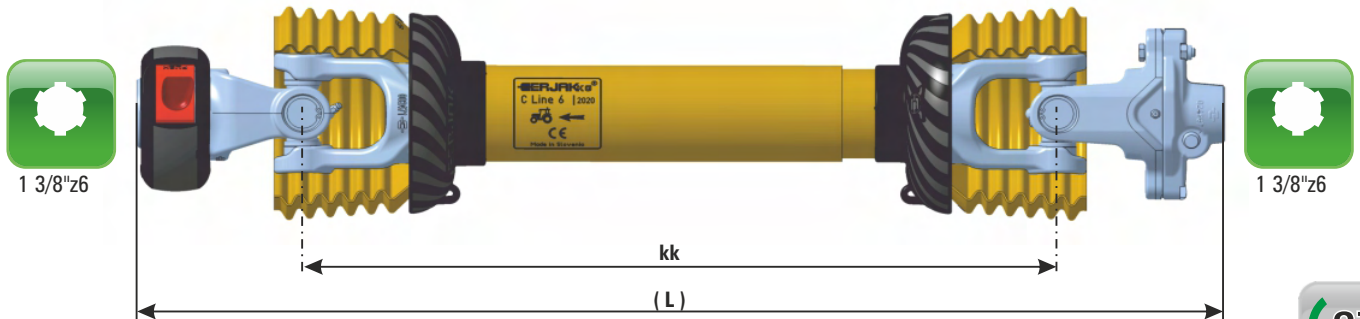

ARTICLE	DESCRIPTION	PTO DRIVE SHAFT OPERATING LENGHT		EAN 13 BAR CODE
		recommended L	maximum L	
028471	C Line 6 ST 1700Nm kk560 (830)	1003	1045	3838433015691
028472	C Line 6 ST 1700Nm kk610 (880)	1078	1145	3838433015707
027187	C Line 6 ST 1700Nm kk660 (930)	1153	1245	3838433012430
028473	C Line 6 ST 1700Nm kk710 (980)	1228	1345	3838433015714
028474	C Line 6 ST 1700Nm kk760 (1030)	1303	1439	3838433015721
026946	C Line 6 ST 1700Nm kk810 (1080)	1378	1526	3838433012331
028475	C Line 6 ST 1700Nm kk860 (1130)	1453	1614	3838433015738
028476	C Line 6 ST 1700Nm kk910 (1180)	1528	1701	3838433015745
028477	C Line 6 ST 1700Nm kk960 (1230)	1603	1789	3838433015752
025628	C Line 6 ST 1700Nm kk1010 (1280)	1678	1876	3838433011068
028478	C Line 6 ST 1700Nm kk1110 (1380)	1803	2014	3838433015769
028479	C Line 6 ST 1700Nm kk1210 (1480)	1928	2151	3838433015776
028480	C Line 6 ST 1700Nm kk1310 (1580)	2053	2289	3838433015783
028481	C Line 6 ST 1700Nm kk1410 (1680)	2178	2426	3838433015790

PTO DRIVE SHAFT



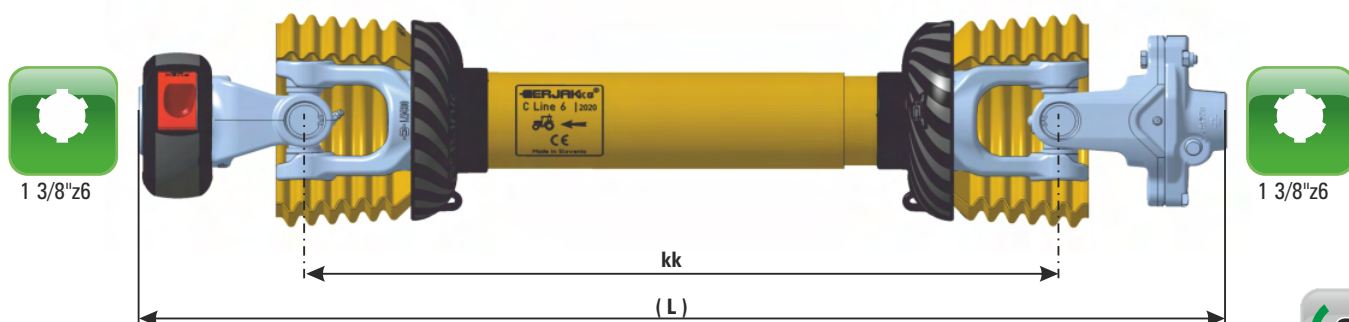





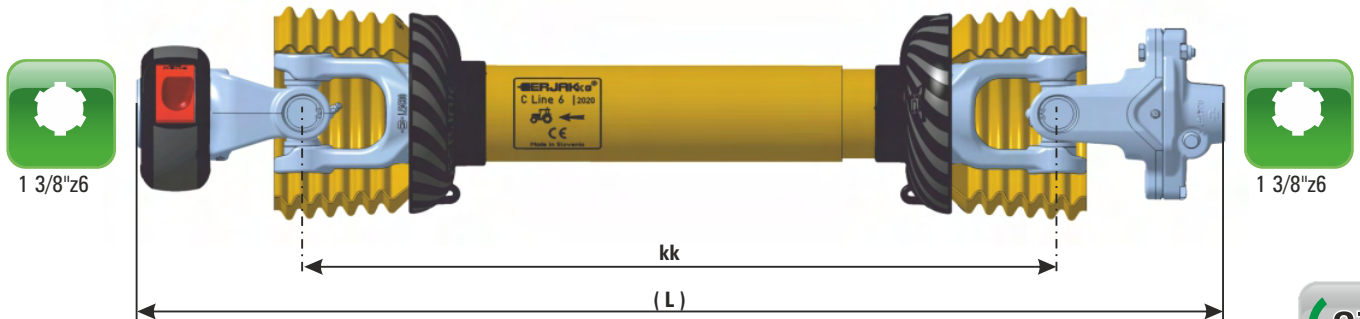





C Line 6 ST 2000Nm



ARTICLE	DESCRIPTION	PTO DRIVE SHAFT OPERATING LENGHT		EAN 13 BAR CODE
		recommended L	maximum L	
028650	C Line 6 ST 2000Nm kk560 (830)	1003	1045	3838433017480
028651	C Line 6 ST 2000Nm kk610 (880)	1078	1145	3838433017497
028652	C Line 6 ST 2000Nm kk660 (930)	1153	1245	3838433017503
028653	C Line 6 ST 2000Nm kk710 (980)	1228	1345	3838433017510
028654	C Line 6 ST 2000Nm kk760 (1030)	1303	1439	3838433017527
028655	C Line 6 ST 2000Nm kk810 (1080)	1378	1526	3838433017534
028656	C Line 6 ST 2000Nm kk860 (1130)	1453	1614	3838433017541
028657	C Line 6 ST 2000Nm kk910 (1180)	1528	1701	3838433017558
028658	C Line 6 ST 2000Nm kk960 (1230)	1603	1789	3838433017565
025932	C Line 6 ST 2000Nm kk1010 (1280)	1678	1876	3838433011280
028659	C Line 6 ST 2000Nm kk1110 (1380)	1803	2014	3838433017572
028660	C Line 6 ST 2000Nm kk1210 (1480)	1928	2151	3838433017589
028661	C Line 6 ST 2000Nm kk1310 (1580)	2053	2289	3838433017596
028662	C Line 6 ST 2000Nm kk1410 (1680)	2178	2426	3838433017602

PTO DRIVE SHAFT C Line 6 ST 2400Nm



ARTICLE	DESCRIPTION	PTO DRIVE SHAFT OPERATING LENGHT		EAN 13 BAR CODE
		recommended L	maximum L	
028831	C Line 6 ST 2400Nm kk560 (830)	1003	1045	3838433019293 
028832	C Line 6 ST 2400Nm kk610 (880)	1078	1145	3838433019309 
028833	C Line 6 ST 2400Nm kk660 (930)	1153	1245	3838433019316 
028834	C Line 6 ST 2400Nm kk710 (980)	1228	1345	3838433019323 
028835	C Line 6 ST 2400Nm kk760 (1030)	1303	1439	3838433019330 
028836	C Line 6 ST 2400Nm kk810 (1080)	1378	1526	3838433019347 
028837	C Line 6 ST 2400Nm kk860 (1130)	1453	1614	3838433019354 
028838	C Line 6 ST 2400Nm kk910 (1180)	1528	1701	3838433019361 
028839	C Line 6 ST 2400Nm kk960 (1230)	1603	1789	3838433019378 
028840	C Line 6 ST 2400Nm kk1010 (1280)	1678	1876	3838433019385 
028841	C Line 6 ST 2400Nm kk1110 (1380)	1803	2014	3838433019392 
028842	C Line 6 ST 2400Nm kk1210 (1480)	1928	2151	3838433019408 
028843	C Line 6 ST 2400Nm kk1310 (1580)	2053	2289	3838433019415 
028844	C Line 6 ST 2400Nm kk1410 (1680)	2178	2426	3838433019422 

PTO DRIVE SHAFT

C Line 6 ST 2700Nm

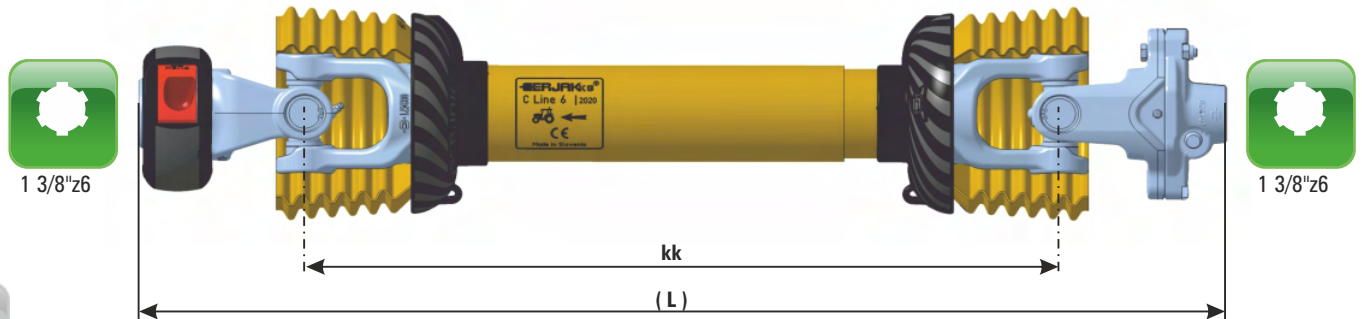

ARTICLE	DESCRIPTION	PTO DRIVE SHAFT OPERATING LENGHT		EAN 13 BAR CODE	EAN 13 BAR CODE
		recommended L	maximum L		
006951	C Line 6 ST 2700Nm kk560 (830)	1003	1045	3831111019486	
006953	C Line 6 ST 2700Nm kk610 (880)	1078	1145	3831111019509	
006955	C Line 6 ST 2700Nm kk660 (930)	1153	1245	3831111019523	
006956	C Line 6 ST 2700Nm kk710 (980)	1228	1345	3831111019530	
006958	C Line 6 ST 2700Nm kk760 (1030)	1303	1439	3831111019554	
006960	C Line 6 ST 2700Nm kk810 (1080)	1378	1526	3831111019578	
006961	C Line 6 ST 2700Nm kk860 (1130)	1453	1614	3831111019585	
006963	C Line 6 ST 2700Nm kk910 (1180)	1528	1701	3831111019608	
006965	C Line 6 ST 2700Nm kk960 (1230)	1603	1789	3831111019622	
006966	C Line 6 ST 2700Nm kk1010 (1280)	1678	1876	3831111019639	
006968	C Line 6 ST 2700Nm kk1110 (1380)	1803	2014	3831111019653	
006969	C Line 6 ST 2700Nm kk1210 (1480)	1928	2151	3831111019660	
006971	C Line 6 ST 2700Nm kk1310 (1580)	2053	2289	3831111019684	
006973	C Line 6 ST 2700Nm kk1410 (1680)	2178	2426	3831111019707	

PTO DRIVE SHAFT C Line 6 TS 1200Nm

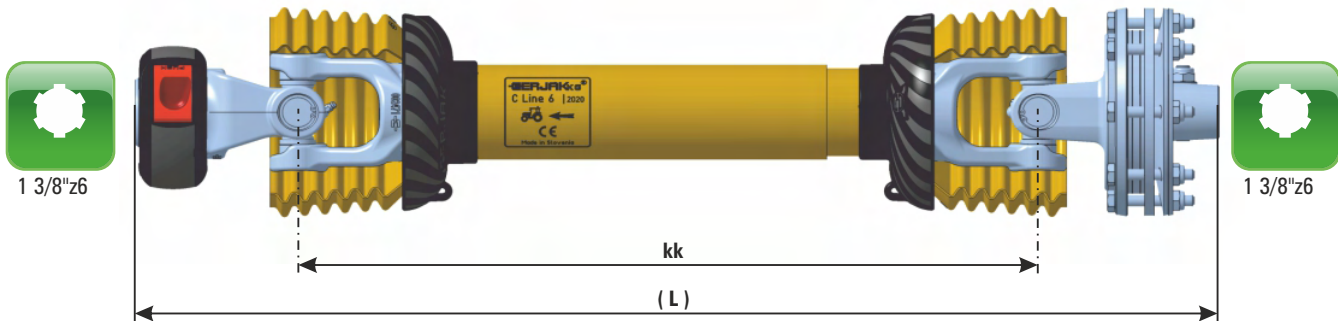

ARTICLE	DESCRIPTION	PTO DRIVE SHAFT OPERATING LENGTH		EAN 13 BAR CODE
		recommended L	maximum L	
006903	C Line 6 TS 1200Nm kk560 (850)	1023	1065	3831111019011
006907	C Line 6 TS 1200Nm kk610 (900)	1098	1165	3831111019059
006909	C Line 6 TS 1200Nm kk660 (950)	1173	1265	3831111019073
006912	C Line 6 TS 1200Nm kk710 (1000)	1248	1365	3831111019103
006914	C Line 6 TS 1200Nm kk760 (1050)	1323	1459	3831111019127
006917	C Line 6 TS 1200Nm kk810 (1100)	1398	1546	3831111019158
006920	C Line 6 TS 1200Nm kk860 (1150)	1473	1634	3831111019189
006923	C Line 6 TS 1200Nm kk910 (1200)	1548	1721	3831111019219
006925	C Line 6 TS 1200Nm kk960 (1250)	1623	1809	3831111019233
006929	C Line 6 TS 1200Nm kk1010 (1300)	1698	1896	3831111019271
006933	C Line 6 TS 1200Nm kk1110 (1400)	1823	2034	3831111019318
006936	C Line 6 TS 1200Nm kk1210 (1500)	1948	2171	3831111019332
006939	C Line 6 TS 1200Nm kk1310 (1600)	2073	2309	3831111019363
006944	C Line 6 TS 1200Nm kk1410 (1700)	2198	2446	3831111019417

*Possible PS + TS

PTO DRIVE SHAFT C Line 8 BR+

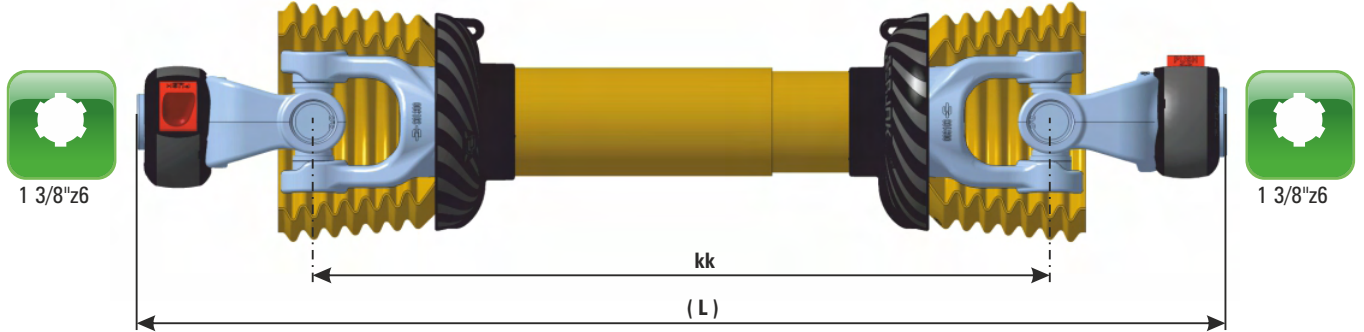

ARTICLE	DESCRIPTION	PTO DRIVE SHAFT OPERATING LENGHT		EAN 13 BAR CODE	
		recommended L	maximum L		
010706	C Line 8 BR+ kk660 (960)	1160	1220	3831111030283	
010708	C Line 8 BR+ kk710 (1010)	1240	1320	3831111030313	
010709	C Line 8 BR+ kk760 (1060)	1310	1420	3831111030320	
010710	C Line 8 BR+ kk810 (1110)	1390	1520	3831111030337	
010711	C Line 8 BR+ kk860 (1160)	1460	1610	3831111030344	
010712	C Line 8 BR+ kk910 (1210)	1540	1700	3831111030351	
010713	C Line 8 BR+ kk960 (1260)	1620	1790	3831111030368	
010714	C Line 8 BR+ kk1010 (1310)	1690	1870	3831111030375	
010715	C Line 8 BR+ kk1110 (1410)	1840	2050	3831111030382	
010716	C Line 8 BR+ kk1210 (1510)	1990	2220	3831111030399	
010717	C Line 8 BR+ kk1310 (1610)	2140	2400	3831111030405	
010718	C Line 8 BR+ kk1410 (1710)	2290	2570	3831111030412	

PTO DRIVE SHAFT C Line 8 PS

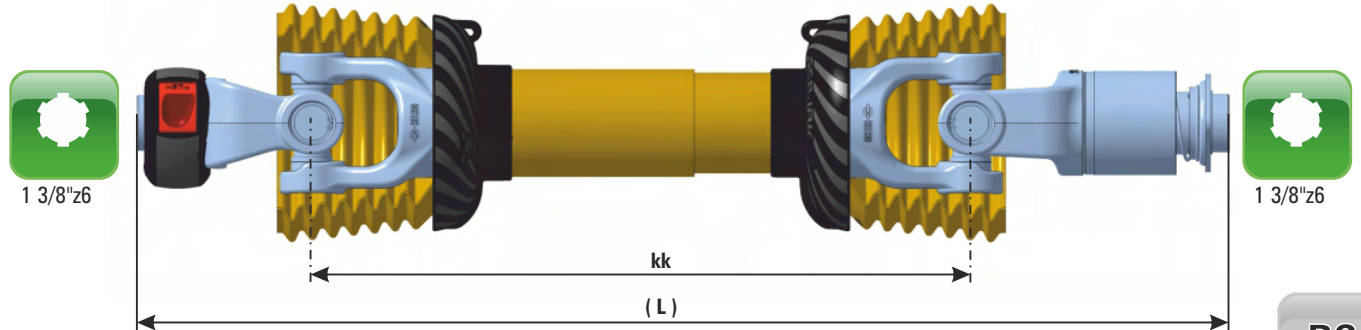

ARTICLE	DESCRIPTION	PTO DRIVE SHAFT OPERATING LENGHT		EAN 13 BAR CODE
		recommended L	maximum L	
010728	C Line 8 PS kk660 (1030)	1230	1290	3831111030474
010789	C Line 8 PS kk710 (1080)	1310	1390	3831111031075
010790	C Line 8 PS kk760 (1130)	1380	1490	3831111031082
010791	C Line 8 PS kk810 (1180)	1460	1590	3831111031099
010792	C Line 8 PS kk860 (1230)	1530	1680	3831111033956
010793	C Line 8 PS kk910 (1280)	1610	1770	3831111031105
010794	C Line 8 PS kk960 (1330)	1690	1860	3831111031112
010795	C Line 8 PS kk1010 (1380)	1760	1940	3831111031129
010796	C Line 8 PS kk1110 (1480)	1910	2120	3831111031136
010797	C Line 8 PS kk1210 (1580)	2060	2290	3831111031143
010798	C Line 8 PS kk1310 (1680)	2210	2470	3831111031150
010799	C Line 8 PS kk1410 (1780)	2360	2640	3831111031167

*Possible PS + TS

PTO DRIVE SHAFT C Line 8 PSL

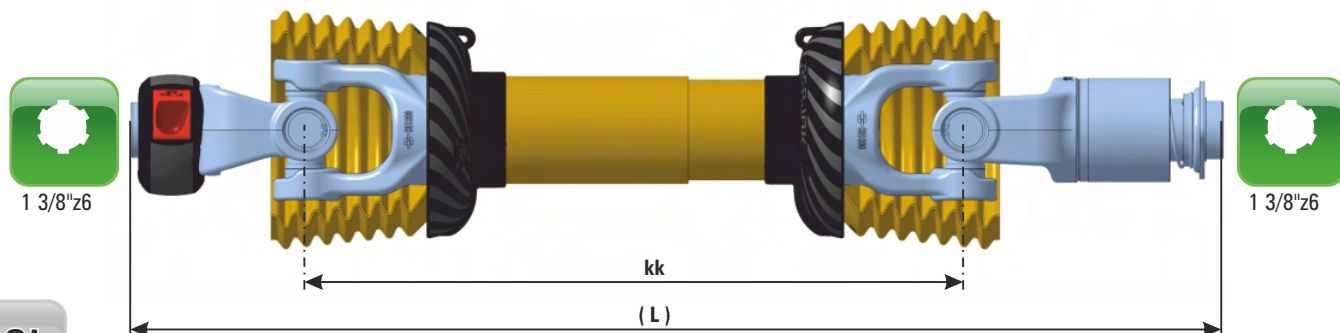

ARTICLE	DESCRIPTION	PTO DRIVE SHAFT OPERATING LENGHT		EAN 13 BAR CODE	
		recommended L	maximum L		
012504	C Line 8 PSL kk660 (1030)	1230	1290	3831111040541	
012505	C Line 8 PSL kk710 (1080)	1310	1390	3831111040558	
012506	C Line 8 PSL kk760 (1130)	1380	1490	3831111040565	
012507	C Line 8 PSL kk810 (1180)	1460	1590	3831111040572	
012508	C Line 8 PSL kk860 (1230)	1530	1680	3831111040589	
012509	C Line 8 PSL kk910 (1280)	1610	1770	3831111040596	
012510	C Line 8 PSL kk960 (1330)	1690	1860	3831111040602	
012511	C Line 8 PSL kk1010 (1380)	1760	1940	3831111040619	
012512	C Line 8 PSL kk1110 (1480)	1910	2120	3831111040626	
012513	C Line 8 PSL kk1210 (1580)	2060	2290	3831111040633	
012514	C Line 8 PSL kk1310 (1680)	2210	2470	3831111040640	
012515	C Line 8 PSL kk1410 (1780)	2360	2640	3831111040657	

PTO DRIVE SHAFT C Line 8 VS1 1500Nm

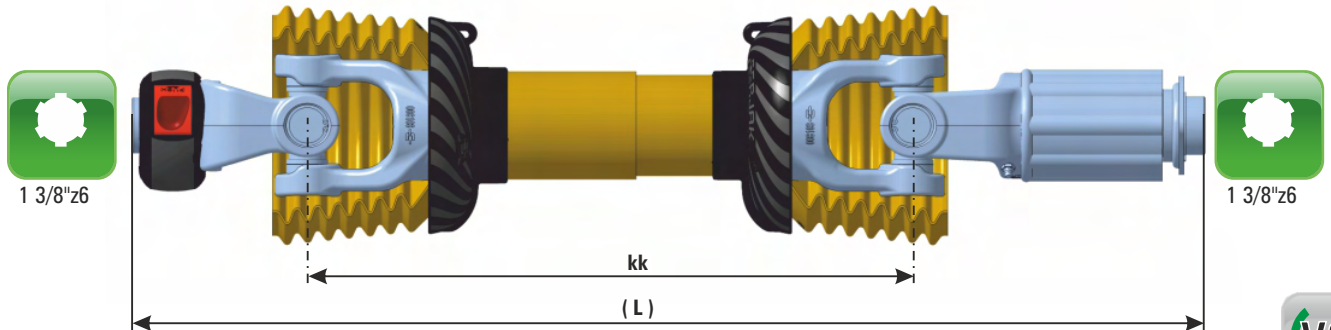







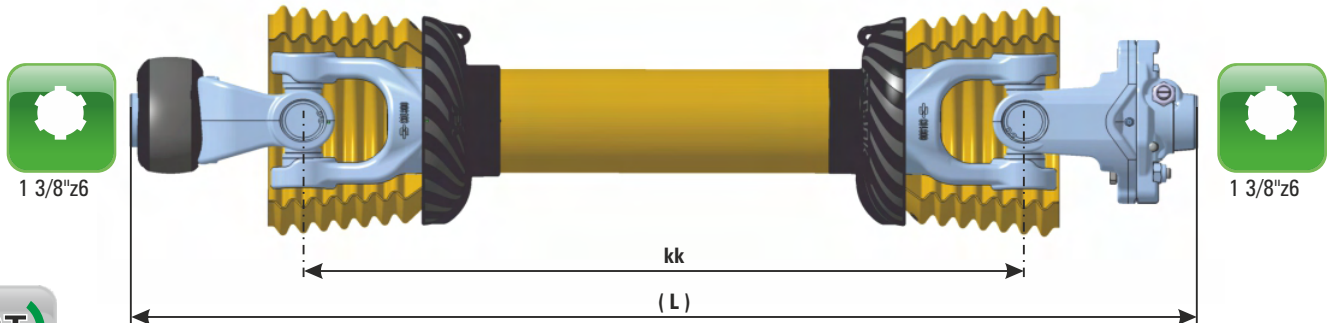

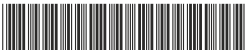

ARTICLE	DESCRIPTION	PTO DRIVE SHAFT OPERATING LENGHT		EAN 13 BAR CODE
		recommended L	maximum L	
019100	C Line 8 VS1 1500Nm kk660 (1050)	1250	1310	3831111097057
019977	C Line 8 VS1 1500Nm kk710 (1100)	1330	1410	3838433000970
019978	C Line 8 VS1 1500Nm kk760 (1150)	1400	1510	3838433000987
019979	C Line 8 VS1 1500Nm kk810 (1200)	1480	1610	3838433000994
019980	C Line 8 VS1 1500Nm kk860 (1250)	1550	1700	3838433001007
019981	C Line 8 VS1 1500Nm kk910 (1300)	1630	1790	3838433001014
019984	C Line 8 VS1 1500Nm kk960 (1350)	1710	1880	3838433001045
019985	C Line 8 VS1 1500Nm kk1010 (1400)	1780	1960	3838433001052
019986	C Line 8 VS1 1500Nm kk1110 (1500)	1930	2140	3838433001069
019987	C Line 8 VS1 1500Nm kk1210 (1600)	2080	2310	3838433001076
019988	C Line 8 VS1 1500Nm kk1310 (1700)	2230	2490	3838433001083
019989	C Line 8 VS1 1500Nm kk1410 (1800)	2380	2660	3838433001090

PTO DRIVE SHAFT









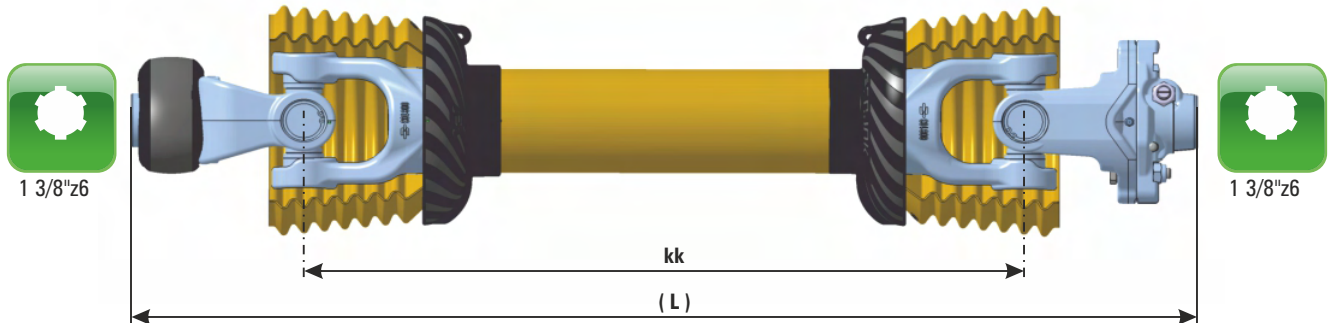



C Line 8 ST 2400Nm



ARTICLE	DESCRIPTION	PTO DRIVE SHAFT OPERATING LENGHT		EAN 13 BAR CODE
		recommended L	maximum L	
027188	C Line 8 ST 2400Nm kk660 (960)	1160	1220	3838433012447 
029177	C Line 8 ST 2400Nm kk710 (1010)	1240	1320	3838433022750 
029178	C Line 8 ST 2400Nm kk760 (1060)	1310	1420	3838433022767 
029179	C Line 8 ST 2400Nm kk810 (1110)	1390	1520	3838433022774 
029180	C Line 8 ST 2400Nm kk860 (1160)	1460	1610	3838433022781 
029181	C Line 8 ST 2400Nm kk910 (1210)	1540	1700	3838433022798 
027247	C Line 8 ST 2400Nm kk960 (1260)	1620	1790	3838433012485 
029182	C Line 8 ST 2400Nm kk1010 (1310)	1690	1870	3838433022804 
029183	C Line 8 ST 2400Nm kk1110 (1410)	1840	2050	3838433022811 
029184	C Line 8 ST 2400Nm kk1210 (1510)	1990	2220	3838433022828 
029185	C Line 8 ST 2400Nm kk1310 (1610)	2140	2400	3838433022835 
029186	C Line 8 ST 2400Nm kk1410 (1710)	2290	2570	3838433022842 

PTO DRIVE SHAFT C Line 8 ST 2700Nm



ARTICLE	DESCRIPTION	PTO DRIVE SHAFT OPERATING LENGHT		EAN 13 BAR CODE
		recommended L	maximum L	
029331	C Line 8 ST 2700Nm kk660 (960)	1160	1220	3838433024297 
029332	C Line 8 ST 2700Nmkk710 (1010)	1240	1320	3838433024303 
029333	C Line 8 ST 2700Nm kk760 (1060)	1310	1420	3838433024310 
029334	C Line 8 ST 2700Nm kk810 (1110)	1390	1520	3838433024327 
029335	C Line 8 ST 2700Nm kk860 (1160)	1460	1610	3838433024334 
029336	C Line 8 ST 2700Nm kk910 (1210)	1540	1700	3838433024341 
029337	C Line 8 ST 2700Nm kk960 (1260)	1620	1790	3838433024358 
029338	C Line 8 ST 2700Nm kk1010 (1310)	1690	1870	3838433024365 
029339	C Line 8 ST 2700Nm kk1110 (1410)	1840	2050	3838433024372 
029340	C Line 8 ST 2700Nm kk1210 (1510)	1990	2220	3838433024389 
029341	C Line 8 ST 2700Nm kk1310 (1610)	2140	2400	3838433024396 
029342	C Line 8 ST 2700Nm kk1410 (1710)	2290	2570	3838433024402 

PTO DRIVE SHAFT

C Line 8 ST 3000Nm

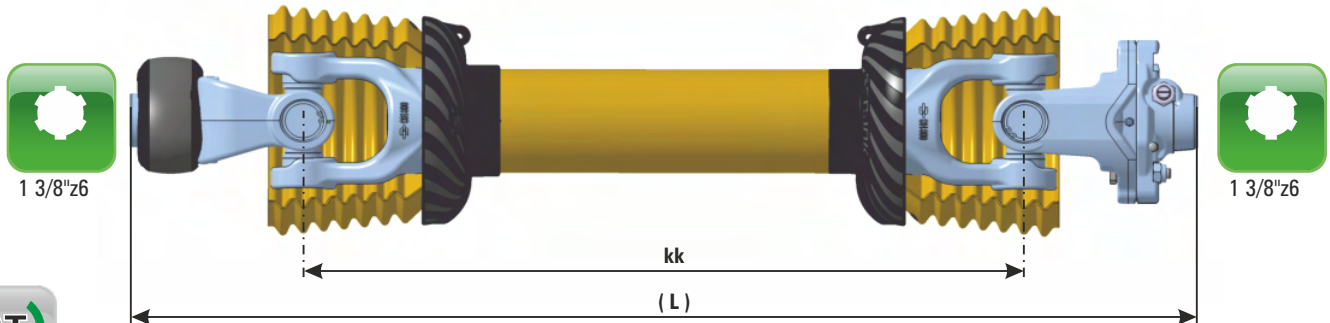

ARTICLE	DESCRIPTION	PTO DRIVE SHAFT OPERATING LENGHT		EAN 13 BAR CODE	
		recommended L	maximum L		
011725	C Line 8 ST 3000Nm kk660 (960)	1160	1220	3831111035929	
019137	C Line 8 ST 3000Nm kk710 (1010)	1240	1320	3831111097132	
019138	C Line 8 ST 3000Nm kk760 (1060)	1310	1420	3831111097149	
019139	C Line 8 ST 3000Nm kk810 (1110)	1390	1520	3831111097156	
011723	C Line 8 ST 3000Nm kk860 (1160)	1460	1610	3831111035905	
019140	C Line 8 ST 3000Nm kk910 (1210)	1540	1700	3831111097163	
019141	C Line 8 ST 3000Nm kk960 (1260)	1620	1790	3831111097170	
019142	C Line 8 ST 3000Nm kk1010 (1310)	1690	1870	3831111097187	
011726	C Line 8 ST 3000Nm kk1110 (1410)	1840	2050	3831111035936	
011747	C Line 8 ST 3000Nm kk1210 (1510)	1990	2220	3831111036001	
019143	C Line 8 ST 3000Nm kk1310 (1610)	2140	2400	3831111097194	
019144	C Line 8 ST 3000Nm kk1410 (1710)	2290	2570	3831111097200	

PTO DRIVE SHAFT C Line 8 ST 3500Nm

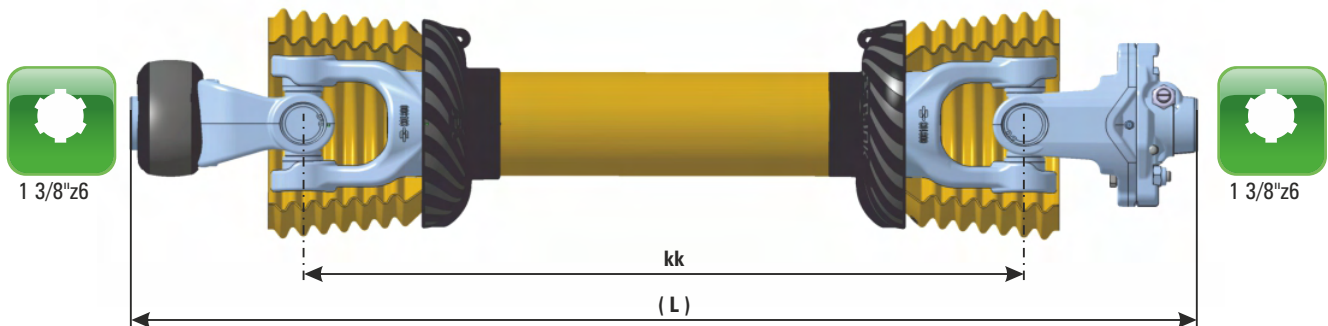

ARTICLE	DESCRIPTION	PTO DRIVE SHAFT OPERATING LENGHT		EAN 13 BAR CODE
		recommended L	maximum L	
010742	C Line 8 ST 3500Nm kk660 (960)	1160	1220	3831111030610
010945	C Line 8 ST 3500Nm kk710 (1010)	1240	1320	3831111032546
010947	C Line 8 ST 3500Nm kk760 (1060)	1310	1420	3831111032560
010948	C Line 8 ST 3500Nm kk810 (1110)	1390	1520	3831111032577
010949	C Line 8 ST 3500Nm kk860 (1160)	1460	1610	3831111034038
010950	C Line 8 ST 3500Nm kk910 (1210)	1540	1700	3831111032584
010951	C Line 8 ST 3500Nm kk960 (12600)	1620	1790	3831111032591
010952	C Line 8 ST 3500Nm kk1010 (1310)	1690	1870	3831111032607
010953	C Line 8 ST 3500Nm kk1110 (1410)	1840	2050	3831111032614
010954	C Line 8 ST 3500Nm kk1210 (1510)	1990	2220	3831111032621
010955	C Line 8 ST 3500Nm kk1310 (1610)	2140	2400	3831111032638
010957	C Line 8 ST 3500Nm kk1410 (1710)	2290	2570	3831111032652

PTO DRIVE SHAFT

C Line 8 TS 1800Nm

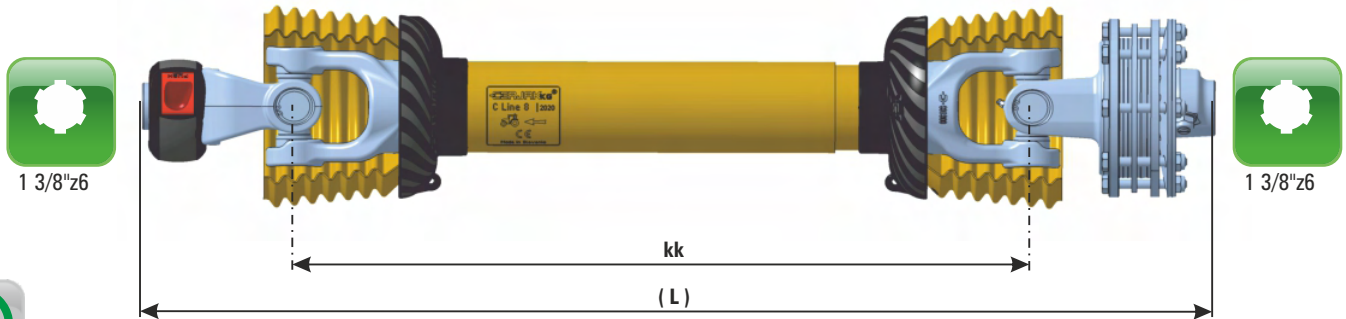

ARTICLE	DESCRIPTION	PTO DRIVE SHAFT OPERATING LENGHT		EAN 13 BAR CODE	
		recommended L	maximum L		
004185	C Line 8 TS 1800Nm kk660 (990)	1190	1250	3831111035318	
019233	C Line 8 TS 1800Nm kk710 (1040)	1270	1350	3831111098092	
019234	C Line 8 TS 1800Nm kk760 (1090)	1340	1450	3831111098108	
019235	C Line 8 TS 1800Nm kk810 (1140)	1420	1550	3831111098115	
019236	C Line 8 TS 1800Nm kk860 (1190)	1490	1640	3831111098122	
019237	C Line 8 TS 1800Nm kk910 (1240)	1570	1730	3831111098139	
019238	C Line 8 TS 1800Nm kk960 (1290)	1650	1820	3831111098146	
019239	C Line 8 TS 1800Nm kk1010 (1340)	1720	1900	3831111098153	
019240	C Line 8 TS 1800Nm kk1110 (1440)	1870	2080	3831111098160	
019241	C Line 8 TS 1800Nm kk1210 (1540)	2020	2250	3831111098177	
019242	C Line 8 TS 1800Nm kk1310 (1640)	2170	2430	3831111098184	
019243	C Line 8 TS 1800Nm kk1410 (1740)	2320	2600	3831111098191	

*Possible +

PTO DRIVE SHAFT C Line 8 TS 2600Nm

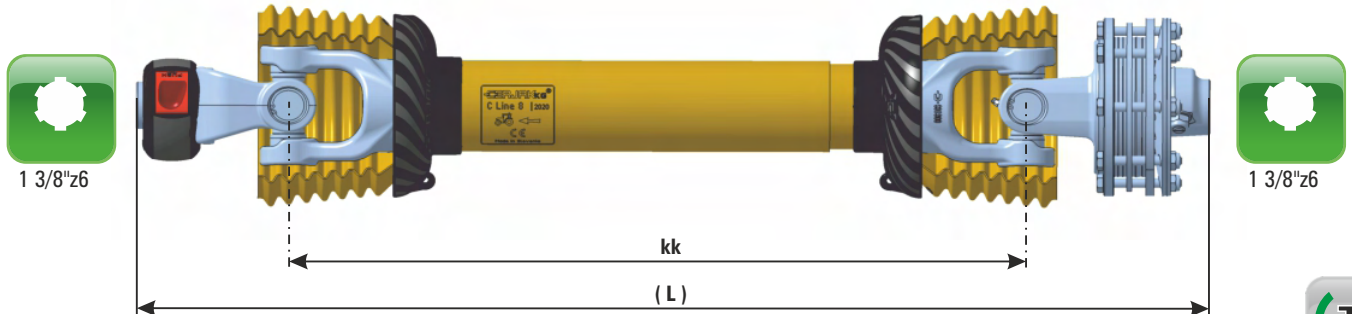

ARTICLE	DESCRIPTION	PTO DRIVE SHAFT OPERATING LENGHT		EAN 13 BAR CODE
		recommended L	maximum L	
010768	C Line 8 TS 2600Nm kk660 (990)	1190	1250	3831111030863
011903	C Line 8 TS 2600Nm kk710 (1040)	1270	1350	3831111037367
011904	C Line 8 TS 2600Nm kk760 (1090)	1340	1450	3831111037374
011905	C Line 8 TS 2600Nm kk810 (1140)	1420	1550	3831111037381
011908	C Line 8 TS 2600Nm kk860 (1190)	1490	1640	3831111037411
011906	C Line 8 TS 2600Nm kk910 (1240)	1570	1730	3831111037398
011907	C Line 8 TS 2600Nm kk960 (1290)	1650	1820	3831111037404
011909	C Line 8 TS 2600Nm kk1010 (1340)	1720	1900	3831111037428
011910	C Line 8 TS 2600Nm kk1110 (1440)	1870	2080	3831111037435
011911	C Line 8 TS 2600Nm kk1210 (1540)	2020	2250	3831111037442
011912	C Line 8 TS 2600Nm kk1310 (1640)	2170	2430	3831111037459
011913	C Line 8 TS 2600Nm kk1410 (1740)	2320	2600	3831111037466

*Possible +

WIDE-ANGLE PTO DRIVE SHAFTS

WIDE-ANGLE PTO DRIVE SHAFT C Line 4 DZ BR+

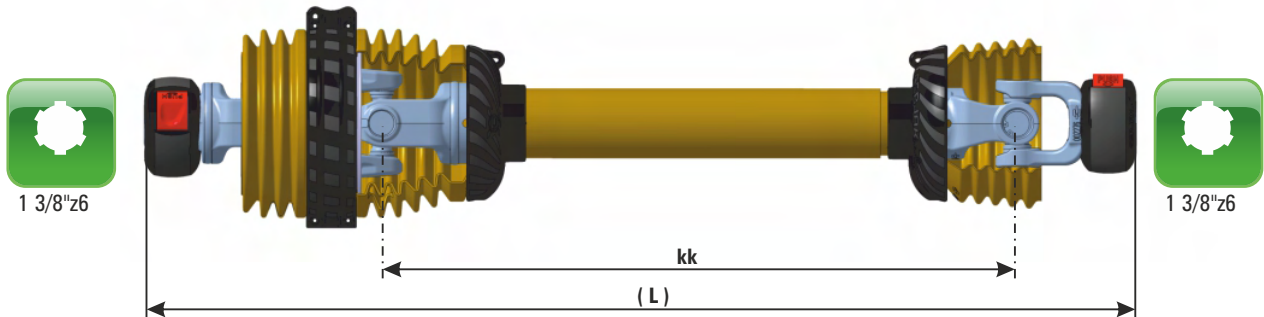

ARTICLE	DESCRIPTION	PTO DRIVE SHAFT OPERATING LENGHT		EAN 13 BAR CODE
		recommended L	maximum L	
013007	C Line 4 DZ BR+ kk710 (1040)	1305	1393	3831111043078
013016	C Line 4 DZ BR+ kk810 (1140)	1455	1560	3831111043160
013025	C Line 4 DZ BR+ kk910 (1240)	1605	1727	3831111043252
012962	C Line 4 DZ BR+ kk1010 (1340)	1755	1893	3831111042620
012971	C Line 4 DZ BR+ kk1210 (1540)	2055	2227	3831111042712
012980	C Line 4 DZ BR+ kk1410 (1740)	2355	2560	3831111042804

WIDE-ANGLE PTO DRIVE SHAFT C Line 4 DZ DZ BR+

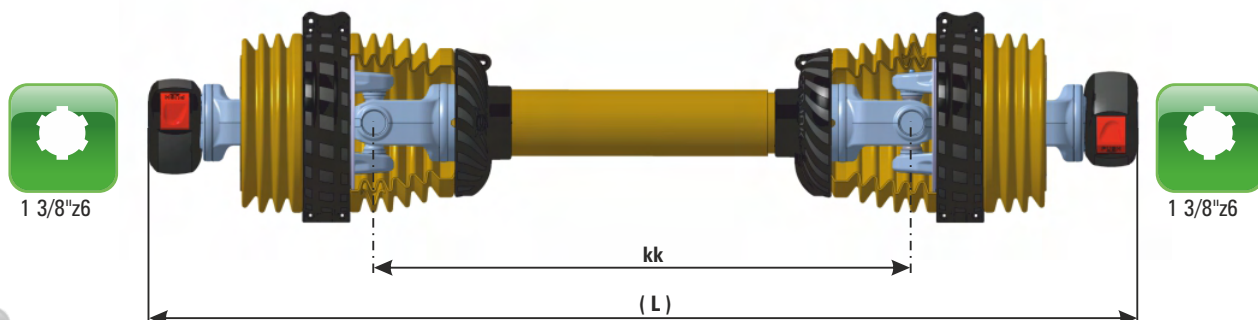

ARTICLE	DESCRIPTION	PTO DRIVE SHAFT OPERATING LENGHT		EAN 13 BAR CODE	
		recommended L	maximum L		
013220	C Line 4 DZ DZ BR+ kk710 (1150)	1415	1503	3831111045201	
013088	C Line 4 DZ DZ BR+ kk810 (1250)	1565	1670	3831111043887	
013097	C Line 4 DZ DZ BR+ kk910 (1350)	1715	1837	3831111043979	
013034	C Line 4 DZ DZ BR+ kk1010 (1450)	1865	2003	3831111043344	
013043	C Line 4 DZ DZ BR+ kk1210 (1650)	2165	2337	3831111043436	
013052	C Line 4 DZ DZ BR+ kk1410 (1850)	2465	2670	3831111043528	

WIDE-ANGLE PTO DRIVE SHAFT C Line 4 DZ PS

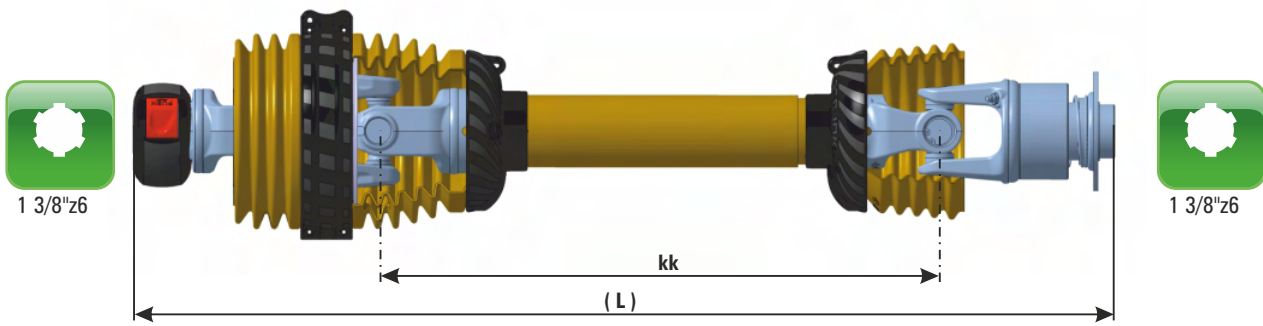

ARTICLE	DESCRIPTION	PTO DRIVE SHAFT OPERATING LENGHT		EAN 13 BAR CODE
		recommended L	maximum L	
013507	C Line 4 DZ PS kk710 (1090)	1355	1443	3831111048073
013516	C Line 4 DZ PS kk810 (1190)	1505	1610	3831111048165
013525	C Line 4 DZ PS kk910 (1290)	1655	1777	3831111048257
013462	C Line 4 DZ PS kk1010 (1390)	1805	1943	3831111047625
013471	C Line 4 DZ PS kk1210 (1590)	2105	2277	3831111047717
013480	C Line 4 DZ PS kk1410 (1790)	2405	2610	3831111047809

*Possible +

WIDE-ANGLE PTO DRIVE SHAFT C Line 4 DZ VS 600Nm

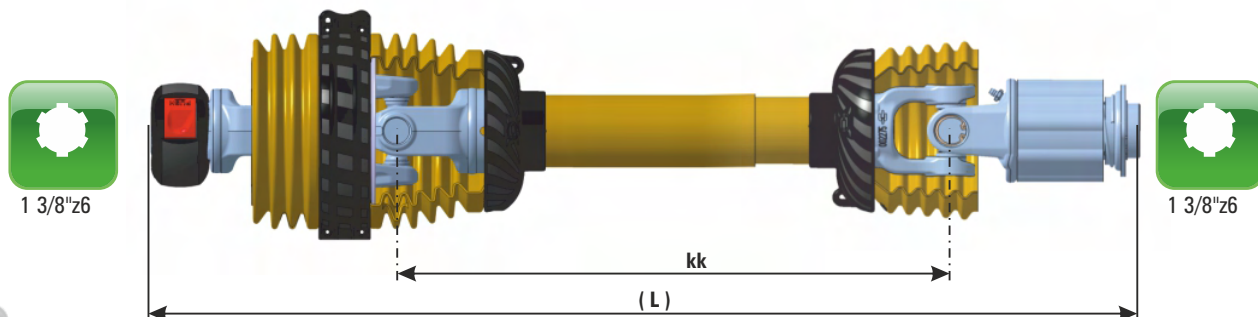

ARTICLE	DESCRIPTION	PTO DRIVE SHAFT OPERATING LENGHT		EAN 13 BAR CODE
		recommended L	maximum L	
013651	C Line 4 DZ VS 600Nm kk710 (1080)	1345	1433	3831111049513
013660	C Line 4 DZ VS 600Nm kk810 (1180)	1495	1600	3831111049605
013669	C Line 4 DZ VS 600Nm kk910 (1280)	1645	1767	3831111049698
013606	C Line 4 DZ VS 600Nm kk1010 (1380)	1795	1933	3831111049063
013615	C Line 4 DZ VS 600Nm kk1210 (1580)	2095	2267	3831111049155
013624	C Line 4 DZ VS 600Nm kk1410 (1780)	2395	2600	3831111049247

WIDE-ANGLE PTO DRIVE SHAFT C Line 4 DZ VS 900Nm

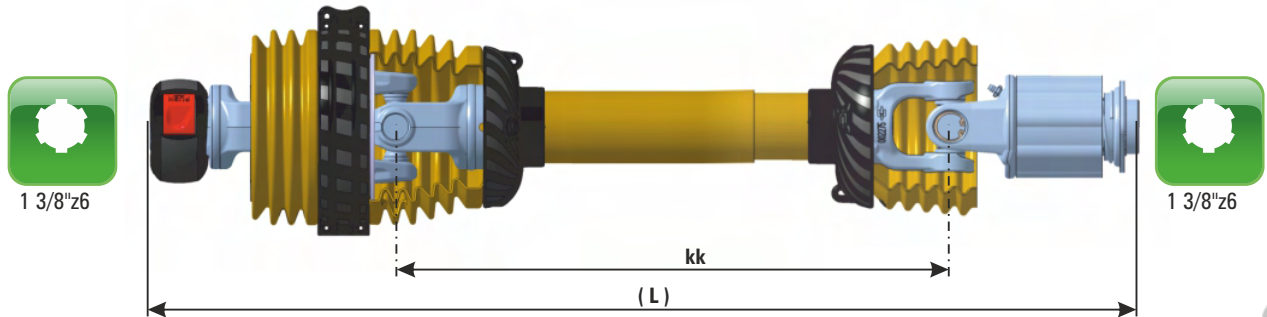

ARTICLE	DESCRIPTION	PTO DRIVE SHAFT OPERATING LENGHT		EAN 13 BAR CODE
		recommended L	maximum L	
013723	C Line 4 DZ VS 900Nm kk710 (1100)	1365	1453	3831111050236
013732	C Line 4 DZ VS 900Nm kk810 (1200)	1515	1620	3831111050328
013741	C Line 4 DZ VS 900Nm kk910 (1300)	1665	1787	3831111050410
013678	C Line 4 DZ VS 900Nm kk1010 (1400)	1815	1953	3831111049780
013687	C Line 4 DZ VS 900Nm kk1210 (1600)	2115	2287	3831111049872
013696	C Line 4 DZ VS 900Nm kk1410 (1800)	2415	2620	3831111049964

WIDE-ANGLE PTO DRIVE SHAFT

C Line 4 DZ ST 900Nm

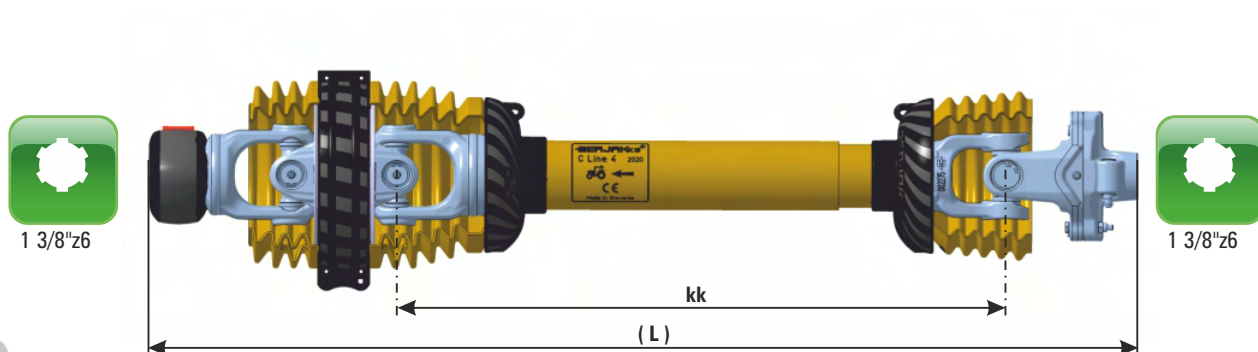

ARTICLE	DESCRIPTION	PTO DRIVE SHAFT OPERATING LENGHT		EAN 13 BAR CODE	EAN 13 BAR CODE
		recommended L	maximum L		
024033	C Line 4 DZ ST 900Nm kk710 (1040)	1305	1393	3838433008471	
024036	C Line 4 DZ ST 900Nm kk810 (1140)	1455	1560	3838433008501	
021536	C Line 4 DZ ST 900Nm kk910 (1240)	1605	1727	3838433003995	
024037	C Line 4 DZ ST 900Nm kk1010 (1340)	1755	1893	3838433008518	
024038	C Line 4 DZ ST 900Nm kk1210 (1540)	2055	2227	3838433008525	
024039	C Line 4 DZ ST 900Nm kk1410 (1740)	2355	2560	3838433008532	

WIDE-ANGLE PTO DRIVE SHAFT C Line 4 DZ ST 1300Nm

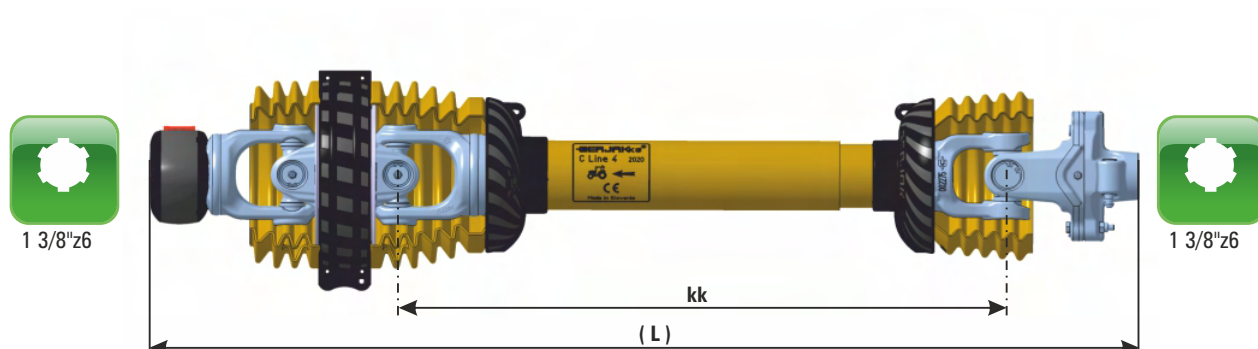

ARTICLE	DESCRIPTION	PTO DRIVE SHAFT OPERATING LENGHT		EAN 13 BAR CODE
		recommended L	maximum L	
029740	C Line 4 DZ ST 1300Nm kk710 (1060)	1325	1413	3838433028387
029741	C Line 4 DZ ST 1300Nm kk810 (1160)	1475	1580	3838433028394
029742	C Line 4 DZ ST 1300Nm kk910 (1260)	1625	1747	3838433028400
024637	C Line 4 DZ ST 1300Nm kk1010 (1360)	1775	1913	3838433009324
029743	C Line 4 DZ ST 1300Nm kk1210 (1560)	2075	2247	3838433028417
025385	C Line 4 DZ ST 1300Nm kk1410 (1760)	2375	2580	3838433010740

WIDE-ANGLE PTO DRIVE SHAFT

C Line 4 DZ ST 1700Nm

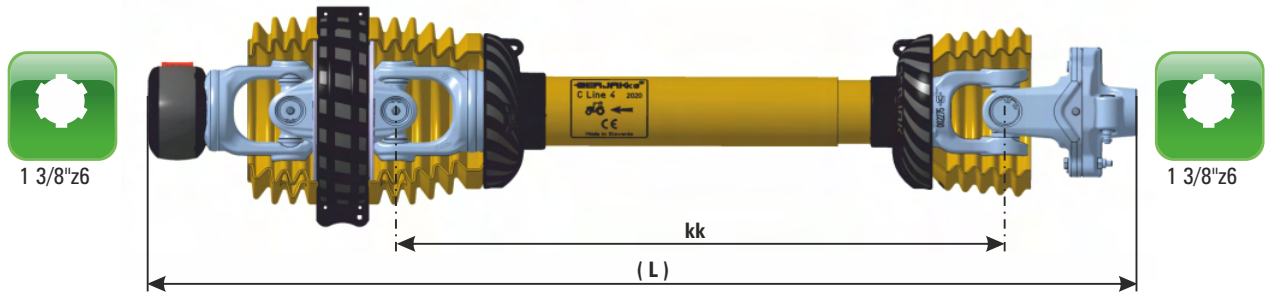

ARTICLE	DESCRIPTION	PTO DRIVE SHAFT OPERATING LENGHT		EAN 13 BAR CODE
		recommended L	maximum L	
024041	C Line 4 DZ ST 1700Nm kk710 (1060)	1325	1413	3838433008556
024040	C Line 4 DZ ST 1700Nm kk810 (1160)	1475	1580	3838433008549
021083	C Line 4 DZ ST 1700Nm kk910 (1260)	1625	1747	3838433003537
020435	C Line 4 DZ ST 1700Nm kk1010 (1360)	1775	1913	3838433002257
022904	C Line 4 DZ ST 1700Nm kk1210 (1560)	2075	2247	3838433007245
022905	C Line 4 DZ ST 1700Nm kk1410 (1760)	2375	2580	3838433007252

WIDE-ANGLE PTO DRIVE SHAFT C Line 4 DZ TS 800Nm

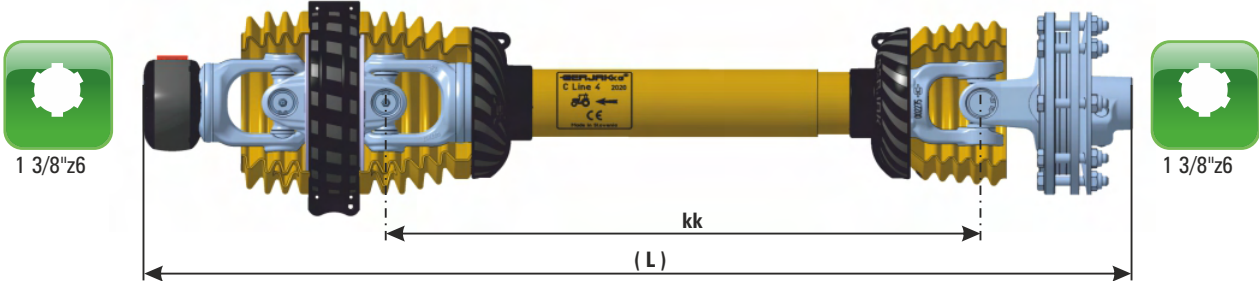

ARTICLE	DESCRIPTION	PTO DRIVE SHAFT OPERATING LENGHT		EAN 13 BAR CODE
		recommended L	maximum L	
013579	C Line 4 DZ TS 800Nm kk710 (1060)	1325	1413	3831111048790
013588	C Line 4 DZ TS 800Nm kk810 (1160)	1475	1580	3831111048882
013597	C Line 4 DZ TS 800Nm kk910 (1260)	1625	1747	3831111048974
013534	C Line 4 DZ TS 800Nm kk1010 (1360)	1775	1913	3831111048349
013543	C Line 4 DZ TS 800Nm kk1210 (1560)	2075	2247	3831111048431
013552	C Line 4 DZ TS 800Nm kk1410 (1760)	2375	2580	3831111048523

*Possible  + 

WIDE-ANGLE PTO DRIVE SHAFT C Line 6 DZ BR+

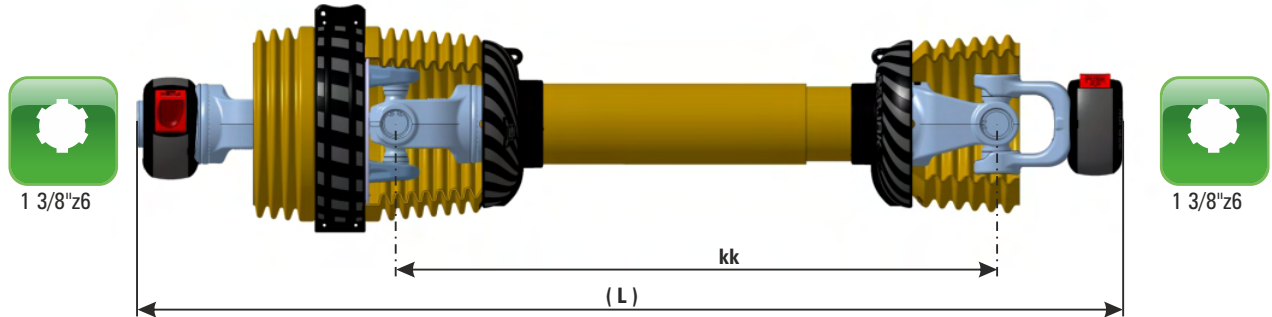

ARTICLE	DESCRIPTION	PTO DRIVE SHAFT OPERATING LENGHT		EAN 13 BAR CODE	
		recommended L	maximum L		
014075	C Line 6 DZ BR+ kk710 (1100)	1348	1430	3831111053756	
014100	C Line 6 DZ BR+ kk810 (1200)	1498	1597	3831111054005	
014125	C Line 6 DZ BR+ kk910 (1300)	1648	1763	3831111054258	
013950	C Line 6 DZ BR+ kk1010 (1400)	1798	1930	3831111052506	
013975	C Line 6 DZ BR+ kk1210 (1600)	2098	2263	3831111052759	
014000	C Line 6 DZ BR+ kk1410 (1800)	2398	2597	3831111053008	

WIDE-ANGLE PTO DRIVE SHAFT C Line 6 DZ DZ BR+

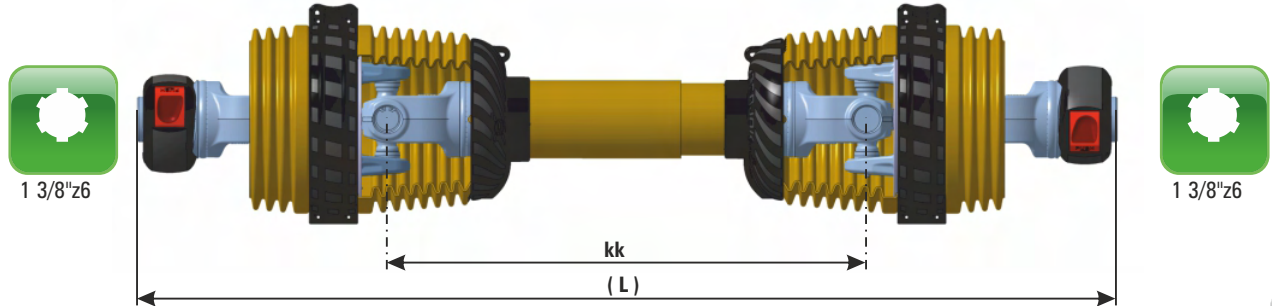

ARTICLE	DESCRIPTION	PTO DRIVE SHAFT OPERATING LENGTH		EAN 13 BAR CODE
		recommended L	maximum L	
014875	C Line 6 DZ DZ BR+ kk710 (1230)	1478	1560	3831111061751
014900	C Line 6 DZ DZ BR+ kk810 (1330)	1628	1727	3831111062000
014925	C Line 6 DZ DZ BR+ kk910 (1430)	1778	1893	3831111062253
014150	C Line 6 DZ DZ BR+ kk1010 (1530)	1928	2060	3831111054500
014775	C Line 6 DZ DZ BR+ kk1210 (1730)	2228	2393	3831111060754
014200	C Line 6 DZ DZ BR+ kk1410 (1930)	2528	2727	3831111055002

WIDE-ANGLE PTO DRIVE SHAFT C Line 6 DZ PS

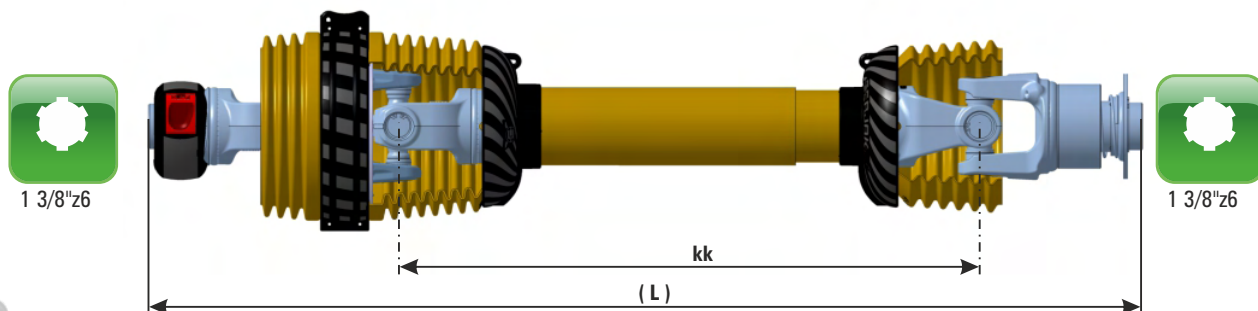

ARTICLE	DESCRIPTION	PTO DRIVE SHAFT OPERATING LENGHT		EAN 13 BAR CODE	
		recommended L	maximum L		
015475	C Line 6 DZ PS kk710 (1140)	1388	1470	3831111067753	
015500	C Line 6 DZ PS kk810 (1240)	1538	1637	3831111068002	
015525	C Line 6 DZ PS kk910 (1340)	1688	1803	3831111068255	
015350	C Line 6 DZ PS kk1010 (1440)	1838	1970	3831111066503	
015375	C Line 6 DZ PS kk1210 (1640)	2138	2303	3831111066756	
015400	C Line 6 DZ PS kk1410 (1840)	2438	2637	3831111067005	

*Possible PS + TS

WIDE-ANGLE PTO DRIVE SHAFT C Line 6 DZ VS1 1200Nm

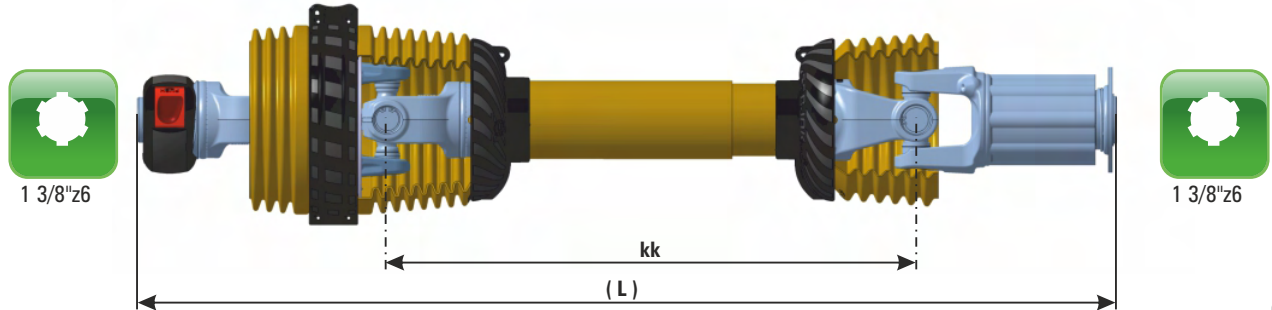

ARTICLE	DESCRIPTION	PTO DRIVE SHAFT OPERATING LENGHT		EAN 13 BAR CODE
		recommended L	maximum L	
015875	C Line 6 DZ VS1 1200Nm kk710 (1180)	1428	1510	3831111071750
015900	C Line 6 DZ VS1 1200Nm kk810 (1280)	1578	1677	3831111072009
015925	C Line 6 DZ VS1 1200Nm kk910 (1380)	1728	1843	3831111072252
015750	C Line 6 DZ VS1 1200Nm kk1010 (1480)	1878	2010	3831111070500
015775	C Line 6 DZ VS1 1200Nm kk1210 (1680)	2178	2343	3831111070753
015800	C Line 6 DZ VS1 1200Nm kk1410 (1880)	2478	2677	3831111071002

WIDE-ANGLE PTO DRIVE SHAFT

C Line 6 DZ VS1 1500Nm

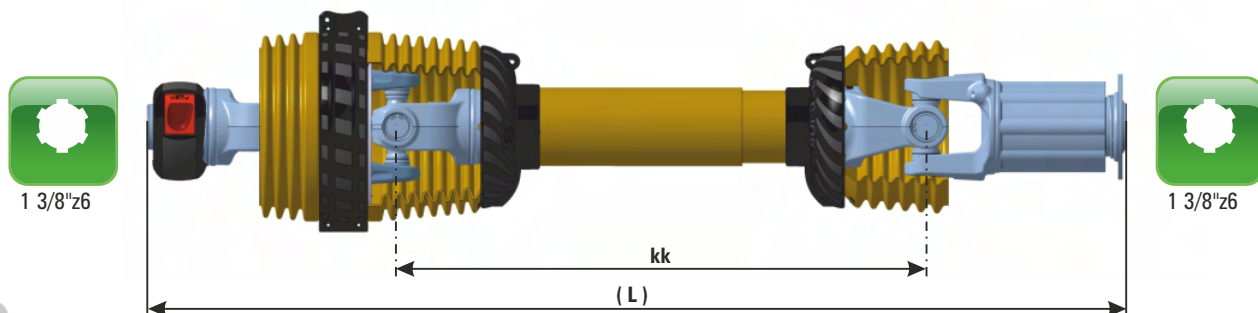

ARTICLE	DESCRIPTION	PTO DRIVE SHAFT OPERATING LENGHT		EAN 13 BAR CODE
		recommended L	maximum L	
016075	C Line 6 DZ VS1 1500Nm kk710 (1200)	1448	1530	3831111073754
016100	C Line 6 DZ VS1 1500Nm kk810 (1300)	1598	1697	3831111074003
016125	C Line 6 DZ VS1 1500Nm kk910 (1400)	1748	1863	3831111074256
015950	C Line 6 DZ VS1 1500Nm kk1010 (1500)	1898	2030	3831111072504
015975	C Line 6 DZ VS1 1500Nm kk1210 (1700)	2198	2363	3831111072757
016000	C Line 6 DZ VS1 1500Nm kk1410 (1900)	2498	2697	3831111073006

WIDE-ANGLE PTO DRIVE SHAFT C Line 6 DZ ST 1700Nm

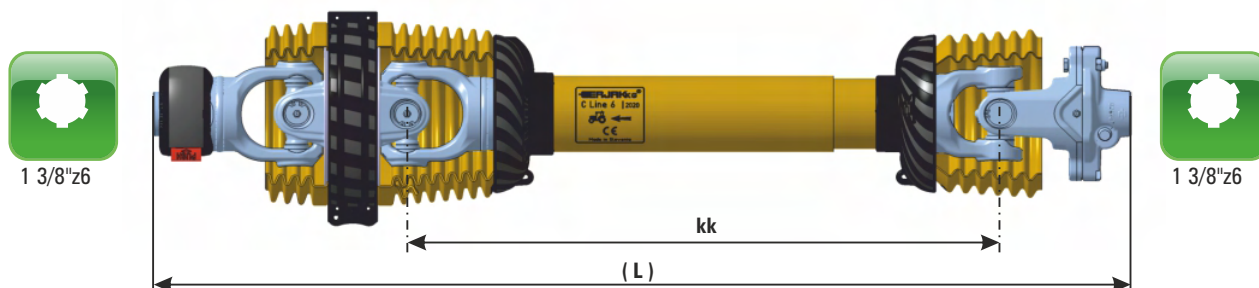

ARTICLE	DESCRIPTION	PTO DRIVE SHAFT OPERATING LENGHT		EAN 13 BAR CODE
		recommended L	maximum L	
029876	C Line 6 DZ ST 1700Nm kk710 (1110)	1358	1440	3838433029742
029877	C Line 6 DZ ST 1700Nm kk810 (1210)	1508	1607	3838433029759
028071	C Line 6 DZ ST 1700Nm kk910 (1310)	1658	1773	3838433012850
029878	C Line 6 DZ ST 1700Nm kk1010 (1410)	1808	1940	3838433029766
025632	C Line 6 DZ ST 1700Nm kk1210 (1610)	2108	2273	3838433011082
029879	C Line 6 DZ ST 1700Nm kk1410 (1810)	2408	2607	3838433029773

WIDE-ANGLE PTO DRIVE SHAFT

C Line 6 DZ ST 2000Nm

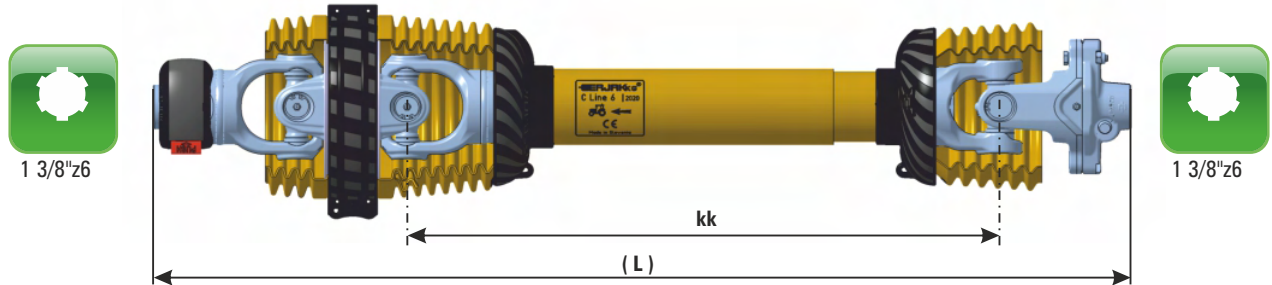

ARTICLE	DESCRIPTION	PTO DRIVE SHAFT OPERATING LENGHT		EAN 13 BAR CODE
		recommended L	maximum L	
030074	C Line 6 DZ ST 2000Nm kk710 (1110)	1358	1440	3838433031721
030075	C Line 6 DZ ST 2000Nm kk810 (1210)	1508	1607	3838433031738
030076	C Line 6 DZ ST 2000Nm kk910 (1310)	1658	1773	3838433031745
026149	C Line 6 DZ ST 2000Nm kk1010 (1410)	1808	1940	3838433011891
030077	C Line 6 DZ ST 2000Nm kk1210 (1610)	2108	2273	3838433031752
030078	C Line 6 DZ ST 2000Nm kk1410 (1810)	2408	2607	3838433031769

WIDE-ANGLE PTO DRIVE SHAFT C Line 6 DZ ST 2400Nm

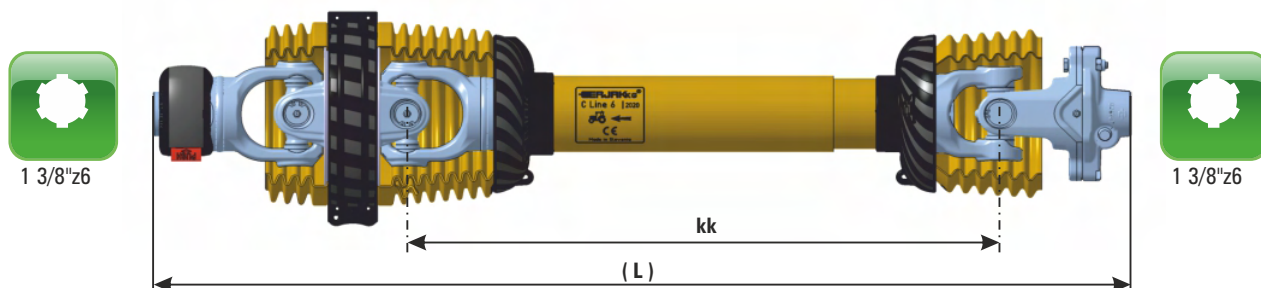

ARTICLE	DESCRIPTION	PTO DRIVE SHAFT OPERATING LENGHT		EAN 13 BAR CODE
		recommended L	maximum L	
030273	C Line 6 DZ ST 2400Nm kk710 (1110)	1358	1440	3838433033718
030274	C Line 6 DZ ST 2400Nm kk810 (1210)	1508	1607	3838433033725
030275	C Line 6 DZ ST 2400Nm kk910 (1310)	1658	1773	3838433033732
030276	C Line 6 DZ ST 2400Nm kk1010 (1410)	1808	1940	3838433033749
030277	C Line 6 DZ ST 2400Nm kk1210 (1610)	2108	2273	3838433033756
030278	C Line 6 DZ ST 2400Nm kk1410 (1810)	2408	2607	3838433033763

WIDE-ANGLE PTO DRIVE SHAFT

C Line 6 DZ ST 2700Nm

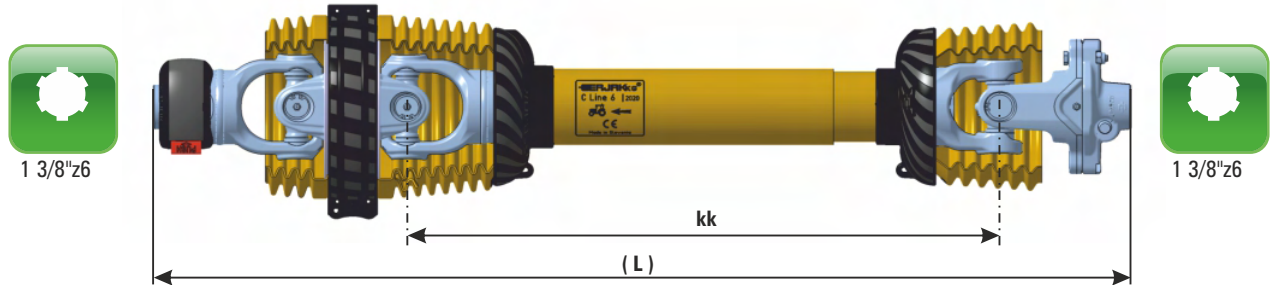

ARTICLE	DESCRIPTION	PTO DRIVE SHAFT OPERATING LENGHT		EAN 13 BAR CODE
		recommended L	maximum L	
024030	C Line 6 DZ ST 2700Nm kk710 (1110)	1358	1440	3838433008464
024029	C Line 6 DZ ST 2700Nm kk810 (1210)	1508	1607	3838433008457
024028	C Line 6 DZ ST 2700Nm kk910 (1310)	1658	1773	3838433008440
020436	C Line 6 DZ ST 2700Nm kk1010 (1410)	1808	1940	3838433002264
022418	C Line 6 DZ ST 2700Nm kk1210 (1610)	2108	2273	3838433006323
020887	C Line 6 DZ ST 2700Nm kk1410 (1810)	2408	2607	3838433003346

WIDE-ANGLE PTO DRIVE SHAFT C Line 6 DZ TS 1200Nm

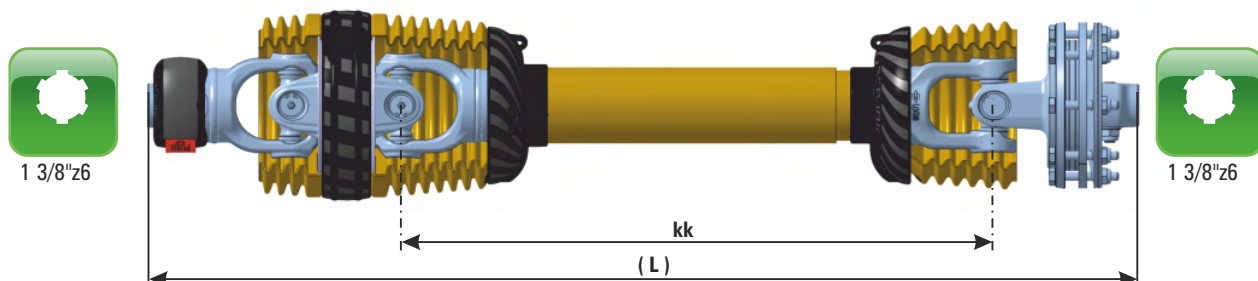

ARTICLE	DESCRIPTION	PTO DRIVE SHAFT OPERATING LENGHT		EAN 13 BAR CODE
		recommended L	maximum L	
015675	C Line 6 DZ TS 1200Nm kk710 (1130)	1378	1460	3831111069757
015700	C Line 6 DZ TS 1200Nm kk810 (1230)	1528	1627	3831111070005
015725	C Line 6 DZ TS 1200Nm kk910 (1330)	1678	1793	3831111070258
015550	C Line 6 DZ TS 1200Nm kk1010 (1430)	1828	1960	3831111068507
015575	C Line 6 DZ TS 1200Nm kk1210 (1630)	2128	2293	3831111068750
015600	C Line 6 DZ TS 1200Nm kk1410 (1830)	2428	2627	3831111069009

*Possible +

WIDE-ANGLE PTO DRIVE SHAFT C Line 8 DZ BR+

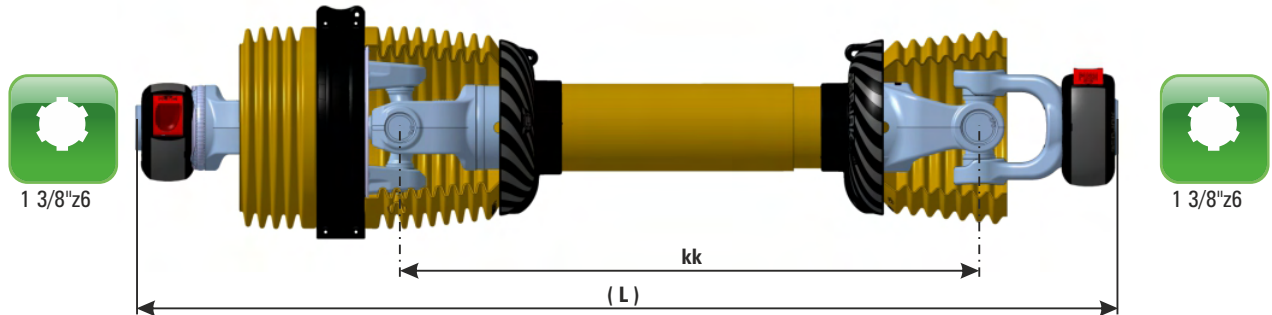

ARTICLE	DESCRIPTION	PTO DRIVE SHAFT OPERATING LENGHT		EAN 13 BAR CODE
		recommended L	maximum L	
016475	C Line 8 DZ BR+ kk710 (1140)	1365	1440	3831111077752
016500	C Line 8 DZ BR+ kk810 (1240)	1515	1607	3831111078001
016525	C Line 8 DZ BR+ kk910 (1340)	1665	1773	3831111078254
016350	C Line 8 DZ BR+ kk1010 (1440)	1815	1940	3831111076502
016375	C Line 8 DZ BR+ kk1210 (1640)	2115	2273	3831111076755
016400	C Line 8 DZ BR+ kk1410 (1840)	2415	2607	3831111077004

WIDE-ANGLE PTO DRIVE SHAFT C Line 8 DZ DZ BR+

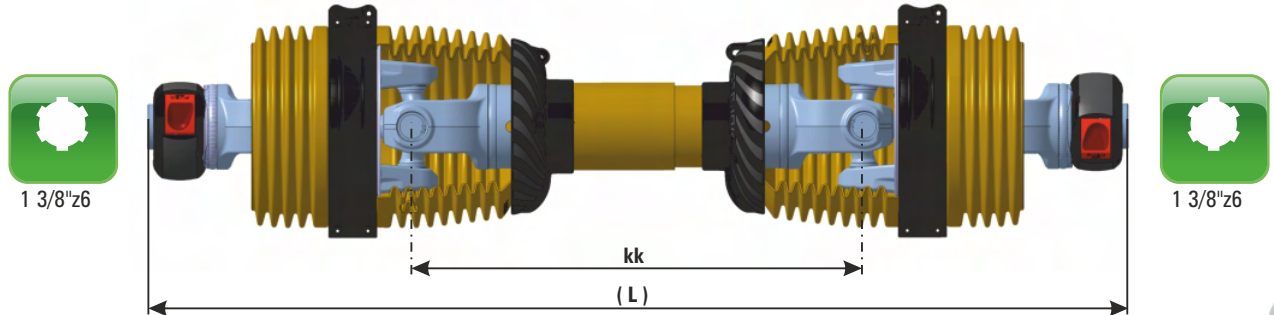

ARTICLE	DESCRIPTION	PTO DRIVE SHAFT OPERATING LENGHT		EAN 13 BAR CODE
		recommended L	maximum L	
017275	C Line 8 DZ DZ BR+ kk710 (1270)	1495	1570	3831111085757
017300	C Line 8 DZ DZ BR+ kk810 (1370)	1645	1737	3831111086006
017325	C Line 8 DZ DZ BR+ kk910 (1470)	1795	1903	3831111086259
016550	C Line 8 DZ DZ BR+ kk1010 (1570)	1945	2070	3831111078506
016575	C Line 8 DZ DZ BR+ kk1210 (1770)	2245	2403	3831111078759
017200	C Line 8 DZ DZ BR+ kk1410 (1970)	2545	2737	3831111085009

WIDE-ANGLE PTO DRIVE SHAFT C Line 8 DZ PS

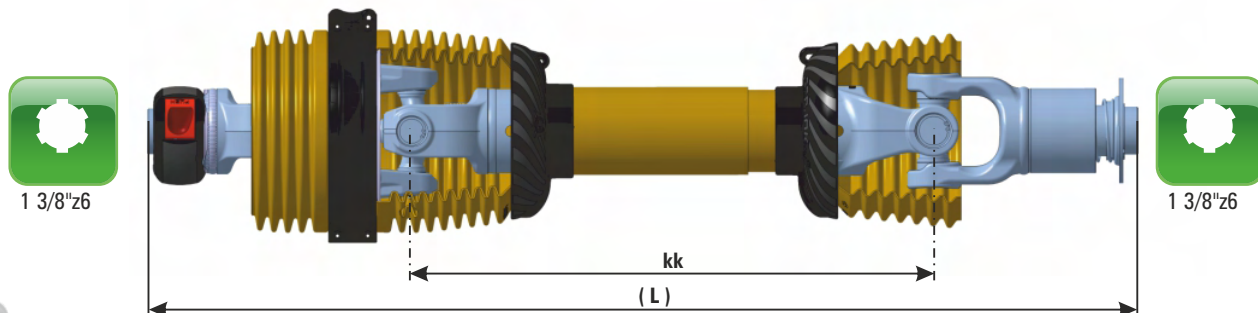

PS
85 kW

8

0° 80°

max.
1000 RPM

ARTICLE	DESCRIPTION	PTO DRIVE SHAFT OPERATING LENGHT		EAN 13 BAR CODE	
		recommended L	maximum L		
017675	C Line 8 DZ PS kk710 (1210)	1435	1510	3831111089755	
017700	C Line 8 DZ PS kk810 (1310)	1585	1677	3831111090003	
017725	C Line 8 DZ PS kk910 (1410)	1735	1843	3831111090256	
017550	C Line 8 DZ PS kk1010 (1510)	1885	2010	3831111088505	
017575	C Line 8 DZ PS kk1210 (1710)	2185	2343	3831111088758	
017600	C Line 8 DZ PS kk1410 (1910)	2485	2677	3831111089007	

*Possible PS + TS

WIDE-ANGLE PTO DRIVE SHAFT C Line 8 DZ VS1 1500Nm

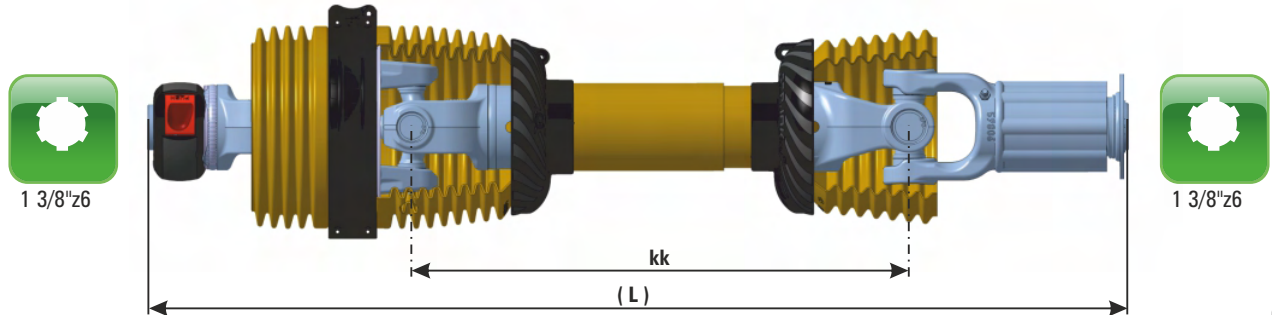

ARTICLE	DESCRIPTION	PTO DRIVE SHAFT OPERATING LENGHT		EAN 13 BAR CODE
		recommended L	maximum L	
024022	C Line 8 DZ VS1 1500Nm kk710 (1240)	1465	1540	3838433008389
024023	C Line 8 DZ VS1 1500Nm kk810 (1340)	1615	1707	3838433008396
024024	C Line 8 DZ VS1 1500Nm kk910 (1440)	1765	1873	3838433008402
024025	C Line 8 DZ VS1 1500Nm kk1010 (1540)	1915	2040	3838433008419
024026	C Line 8 DZ VS1 1500Nm kk1210 (1740)	2215	2373	3838433008426
024027	C Line 8 DZ VS1 1500Nm kk1410 (1940)	2515	2707	3838433008433

WIDE-ANGLE PTO DRIVE SHAFT

C Line 8 DZ ST 2400Nm

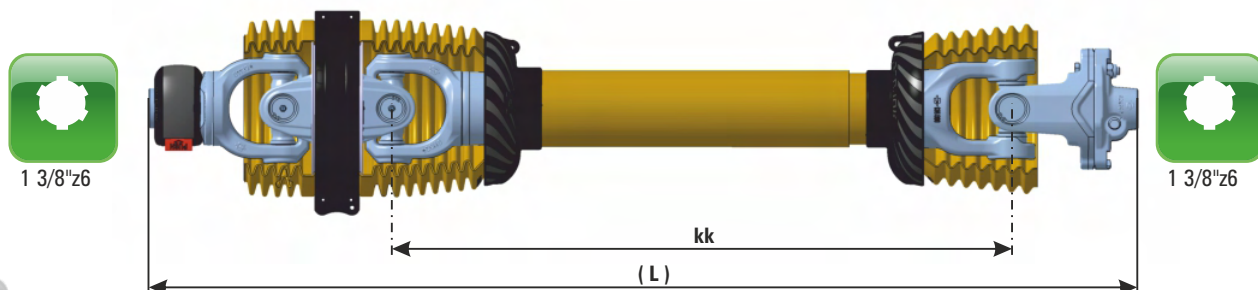

ARTICLE	DESCRIPTION	PTO DRIVE SHAFT OPERATING LENGHT		EAN 13 BAR CODE	EAN 13 BAR CODE
		recommended L	maximum L		
030663	C Line 8 DZ ST 2400Nm kk710 (1140)	1365	1440	3838433037617	
030664	C Line 8 DZ ST 2400Nm kk810 (1240)	1515	1607	3838433037624	
030665	C Line 8 DZ ST 2400Nm kk910 (1340)	1665	1773	3838433037631	
030666	C Line 8 DZ ST 2400Nm kk1010 (1440)	1815	1940	3838433037648	
030667	C Line 8 DZ ST 2400Nm kk1210 (1640)	2115	2273	3838433037655	
030668	C Line 8 DZ ST 2400Nm kk1410 (1840)	2415	2607	3838433037662	

WIDE-ANGLE PTO DRIVE SHAFT C Line 8 DZ ST 2700Nm

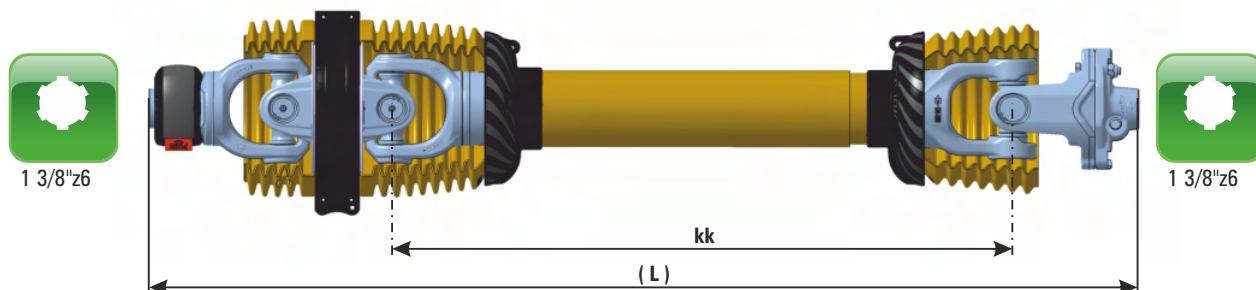

ARTICLE	DESCRIPTION	PTO DRIVE SHAFT OPERATING LENGHT		EAN 13 BAR CODE
		recommended L	maximum L	
030863	C Line 8 DZ ST 2700Nm kk710 (1140)	1365	1440	3838433039611
030864	C Line 8 DZ ST 2700Nm kk810 (1240)	1515	1607	3838433039628
028122	C Line 8 DZ ST 2700Nm kk910 (1340)	1665	1773	3838433012867
030865	C Line 8 DZ ST 2700Nm kk1010 (1440)	1815	1940	3838433039635
030866	C Line 8 DZ ST 2700Nm kk1210 (1640)	2115	2273	3838433039642
030867	C Line 8 DZ ST 2700Nm kk1410 (1840)	2415	2607	3838433039659



WIDE-ANGLE PTO DRIVE SHAFT

C Line 8 DZ ST 3000Nm

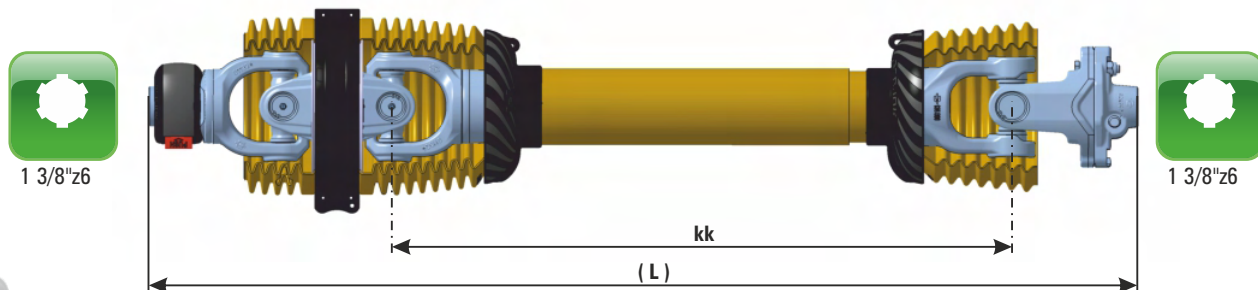

ARTICLE	DESCRIPTION	PTO DRIVE SHAFT OPERATING LENGHT		EAN 13 BAR CODE
		recommended L	maximum L	
024015	C Line 8 DZ ST 3000Nm kk710 (1140)	1365	1440	3838433008310
024013	C Line 8 DZ ST 3000Nm kk810 (1240)	1515	1607	3838433008303
024012	C Line 8 DZ ST 3000Nm kk910 (1340)	1665	1773	3838433008297
022913	C Line 8 DZ ST 3000Nm kk1010 (1440)	1815	1940	3838433007313
022914	C Line 8 DZ ST 3000Nm kk1210 (1640)	2115	2273	3838433007320
022915	C Line 8 DZ ST 3000Nm kk1410 (1840)	2415	2607	3838433007337

WIDE-ANGLE PTO DRIVE SHAFT C Line 8 DZ ST 3500Nm

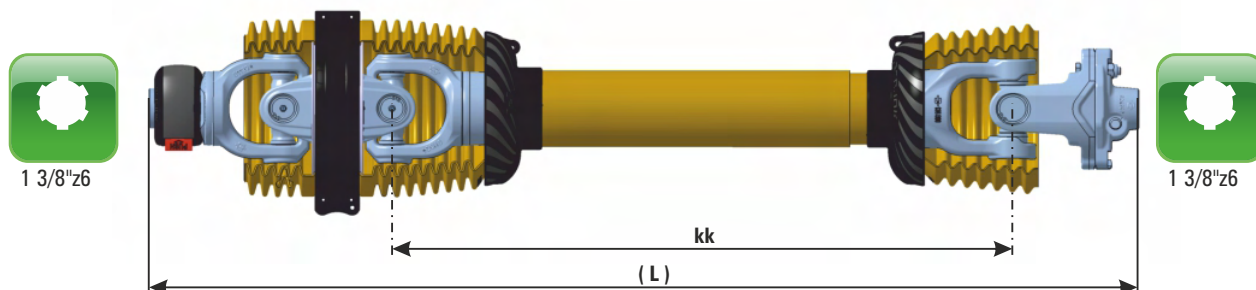

ARTICLE	DESCRIPTION	PTO DRIVE SHAFT OPERATING LENGHT		EAN 13 BAR CODE
		recommended L	maximum L	
024016	C Line 8 DZ ST 3500Nm kk710 (1140)	1365	1440	3838433008327
024017	C Line 8 DZ ST 3500Nm kk810 (1240)	1515	1607	3838433008334
024018	C Line 8 DZ ST 3500Nm kk910 (1340)	1665	1773	3838433008341
024019	C Line 8 DZ ST 3500Nm kk1010 (1440)	1815	1940	3838433008358
024020	C Line 8 DZ ST 3500Nm kk1210 (1640)	2115	2273	3838433008365
024021	C Line 8 DZ ST 3500Nm kk1410 (1840)	2415	2607	3838433008372



WIDE-ANGLE PTO DRIVE SHAFT

C Line 8 DZ TS 1800Nm

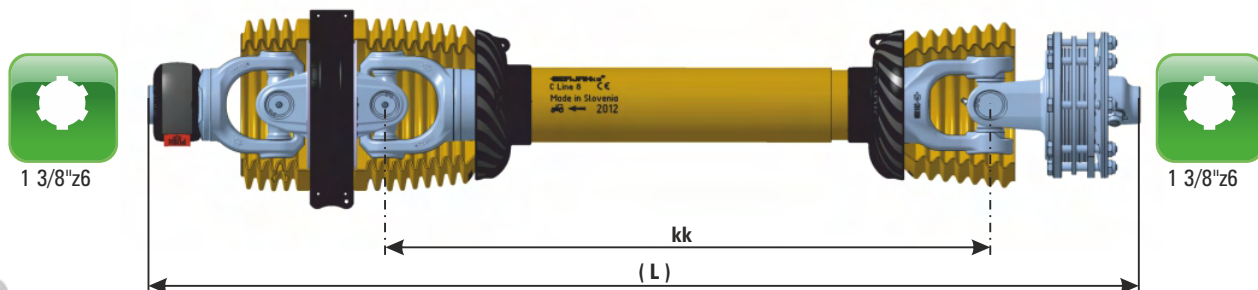

ARTICLE	DESCRIPTION	PTO DRIVE SHAFT OPERATING LENGHT		EAN 13 BAR CODE	EAN 13 BAR CODE
		recommended L	maximum L		
017875	C Line 8 DZ TS 1800Nm kk710 (1170)	1395	1470	3831111091758	
017900	C Line 8 DZ TS 1800Nm kk810 (1270)	1545	1637	3831111092007	
017925	C Line 8 DZ TS 1800Nm kk910 (1370)	1695	1803	3831111092250	
017750	C Line 8 DZ TS 1800Nm kk1010 (1470)	1845	1970	3831111090508	
017775	C Line 8 DZ TS 1800Nm kk1210 (1670)	2145	2303	3831111090751	
017800	C Line 8 DZ TS 1800Nm kk1410 (1870)	2445	2637	3831111091000	

*Possible PS + TS

WIDE-ANGLE PTO DRIVE SHAFT C Line 8 DZ TS 2600Nm

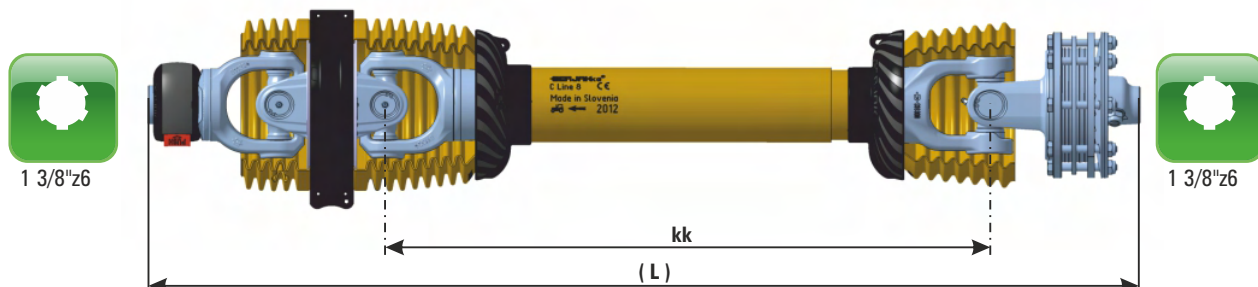

ARTICLE	DESCRIPTION	PTO DRIVE SHAFT OPERATING LENGTH		EAN 13 BAR CODE
		recommended L	maximum L	
018075	C Line 8 DZ TS 2600Nm kk710 (1170)	1395	1470	3831111093752
018100	C Line 8 DZ TS 2600Nm kk810 (1270)	1545	1637	3831111094001
018125	C Line 8 DZ TS 2600Nm kk910 (1370)	1695	1803	3831111094254
017950	C Line 8 DZ TS 2600Nm kk1010 (1470)	1845	1970	3831111092502
017975	C Line 8 DZ TS 2600Nm kk1210 (1670)	2145	2303	3831111092755
018000	C Line 8 DZ TS 2600Nm kk1410 (1870)	2445	2637	3831111093004

*Possible  + 

SPARE PARTS

PTO DRIVE SHAFTS

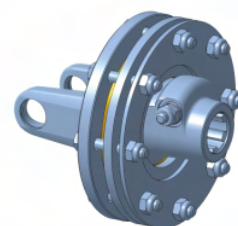
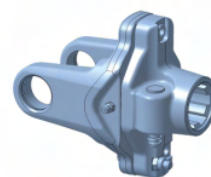
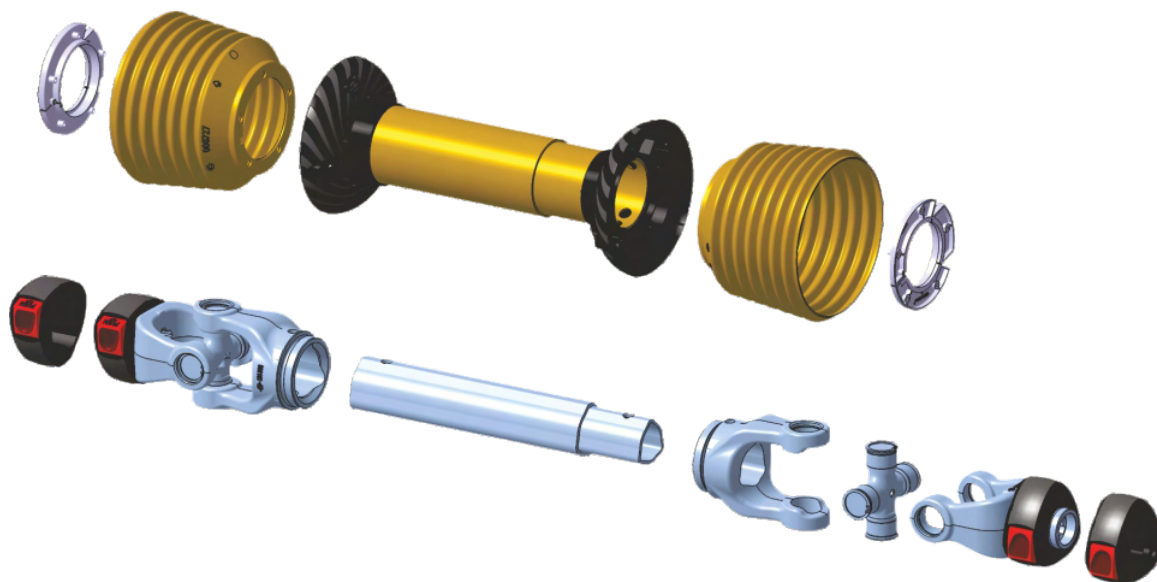

SPARE PARTS

PTO DRIVE SHAFTS

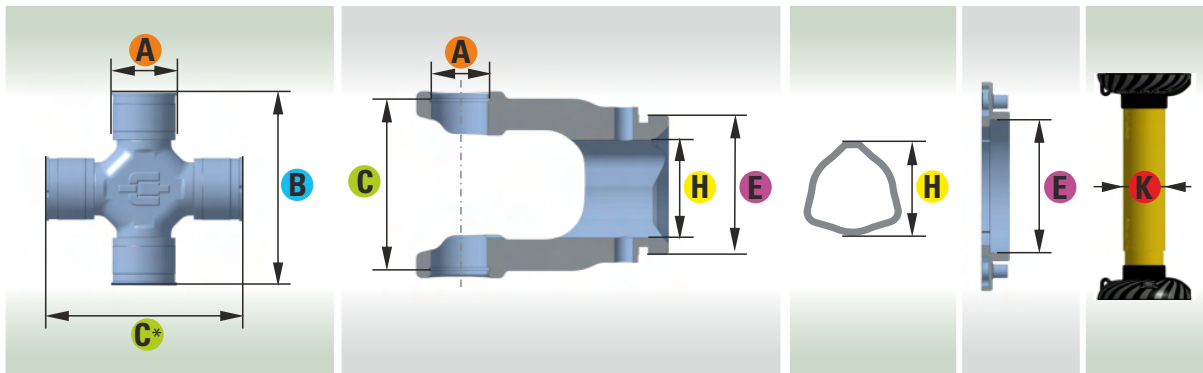

	A	B	C*	A	C	E	H	H	E	K
1	22	55	57*	22	57	47	32,5/26,5	32,5/26,5	47	55,5/50
2	23,8	61,3	63,7*	23,8	63,7	61	36/29	36/29	61	67/61,5
4	27	74,6	77*	27	77	61	43,5/36,5	43,5/36,5	61	67/61,5
6	30,2	91,4	94,4*	30,2	94,4	76	53,5/45,5	53,5/45,5	76	82/76
8	34,9	106	109,45*	34,9	109,45	83,8	62,6/53,6	62,6/53,6	83,8	92/86

*measurement with spring clip



SPARE PARTS PTO DRIVE SHAFTS

C Line 1

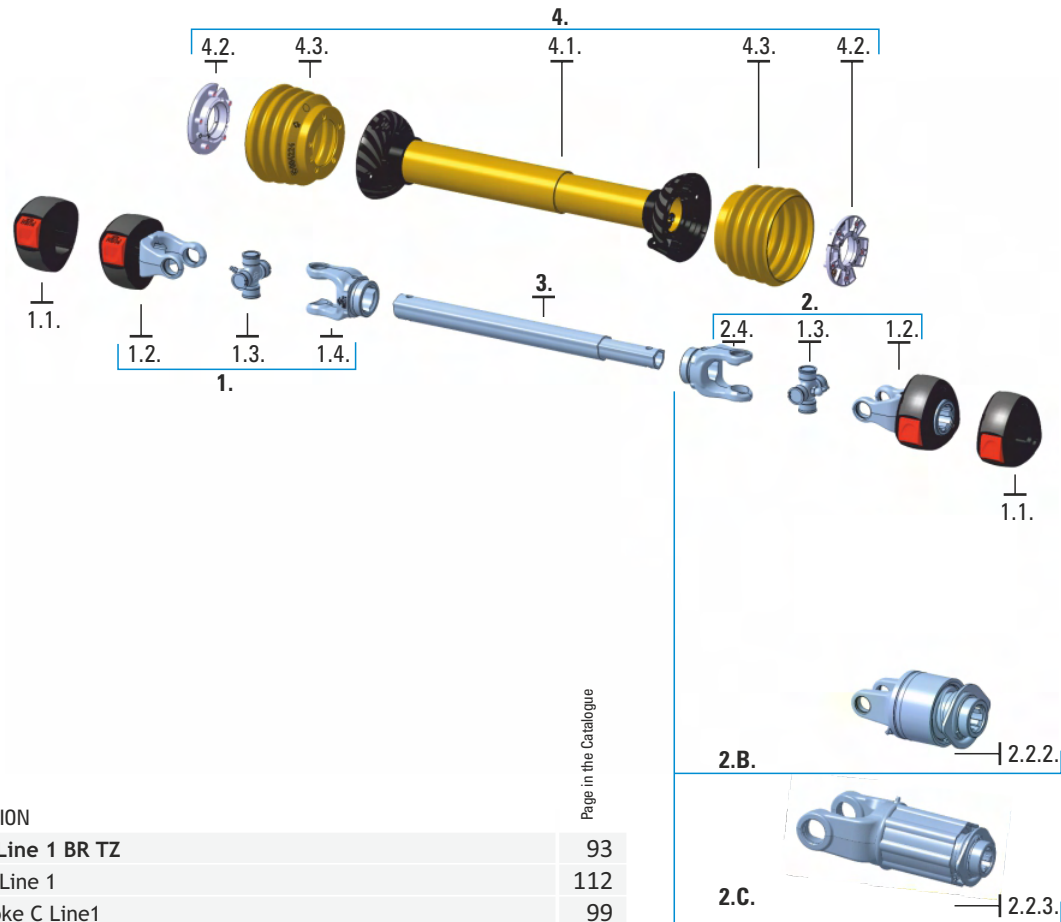

Page in the Catalogue

NO.	DESCRIPTION	
1.	Joint C Line 1 BR TZ	93
1.1.	Cover C Line 1	112
1.2.	Outer yoke C Line1	99
1.3.	Cross C Line 1	98
1.4.	Tube yoke C Line 1 TZ	100
2.	Joint C Line 1 BR TN	93
1.1.	Cover C Line 1	112
1.2.	Outer yoke C Line1	99
1.3.	Cross C Line 1	98
2.4.	Tube yoke C Line 1 TZ	100
2.B.	Joint C Line 1 PS TN / C Line 1 PSL TN	93
2.2.2.	Clutch C Line 1 PS / C Line 1 PSL	101
1.3.	Cross C Line 1	98
2.4.	Tube yoke C Line 1 TN	100
2.C.	Joint C Line 1 VS TN	93
2.2.3.	Clutch C Line 1 VS1	103
1.3.	Cross C Line 1	98
2.4.	Tube yoke C Line 1 TN	100
3.	Metal tube 1 kpl	107
4.	Safety shield C Line 1	113
4.1.	Safety tube with housing C Line 1	119
4.2.	Shield bearing PA C Line 1	118
4.3.	Cone C Line 1	118
	Chain Type C Line	118



C Line 2

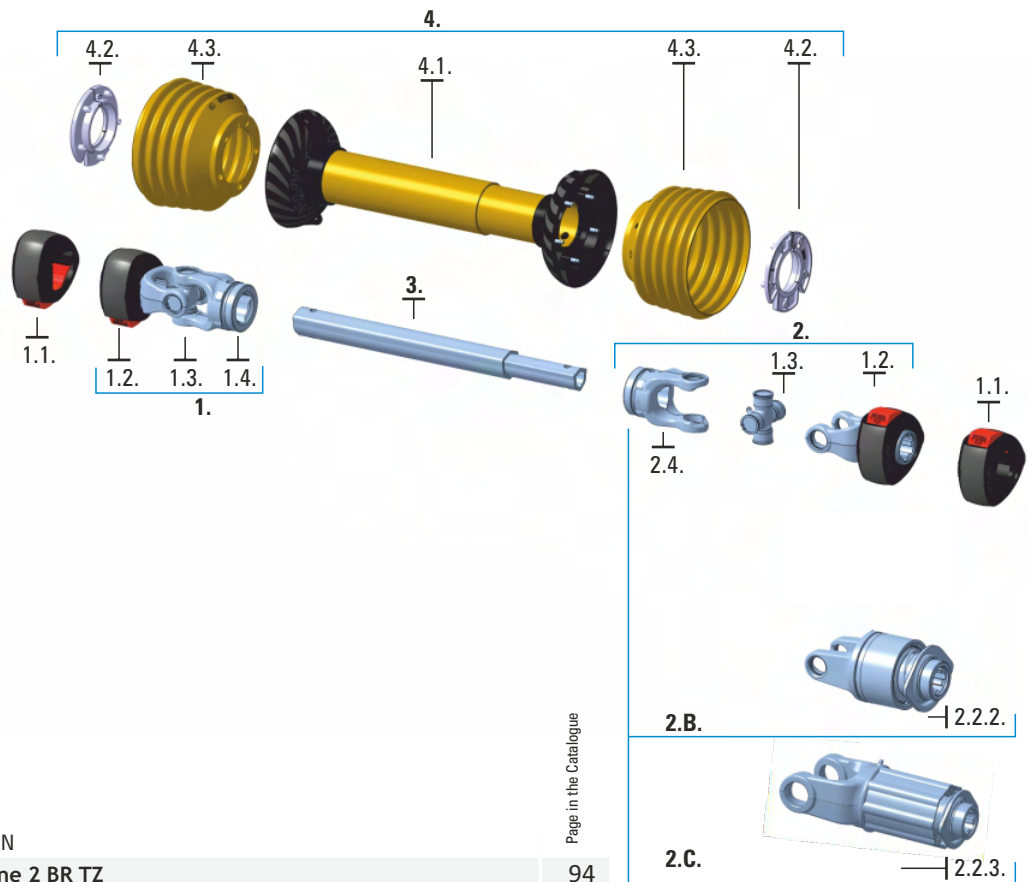

Page in the Catalogue

NO.	DESCRIPTION	
1.	Joint C Line 2 BR TZ	94
1.1.	Cover C Line 2	112
1.2.	Outer yoke C Line 2	99
1.3.	Cross C Line 2	98
1.4.	Tube yoke C Line 2 TZ	100
2.	Joint C Line 2 BR TN	94
1.1.	Cover C Line 2	112
1.2.	Outer yoke C Line 2	99
1.3.	Cross C Line 2	98
2.4.	Tube yoke C Line 2 TN	100
2.B.	Joint C Line 2 PS TN / C Line 2 PSL TN	94
2.2.2.	Clutch C Line 2 PS / C Line 2 PSL	101
1.3.	Cross C Line 2	98
2.4.	Tube yoke C Line 2 TN	100
2.C.	Joint C Line 2 VS1 TN	94
2.2.3.	Clutch C Line 2 VS1	103
1.3.	Cross C Line 2	98
2.4.	Tube yoke C Line 2 TN	100
3.	Metal tube 4 kpl	108
4.	Safety shield C Line 4	114
4.1.	Safety tube with housing C Line 4	120
4.2.	Shield bearing PA C Line 4	118
4.3.	Cone C Line 4	118
	Chain Type C Line	118

SPARE PARTS PTO DRIVE SHAFTS

C Line 4

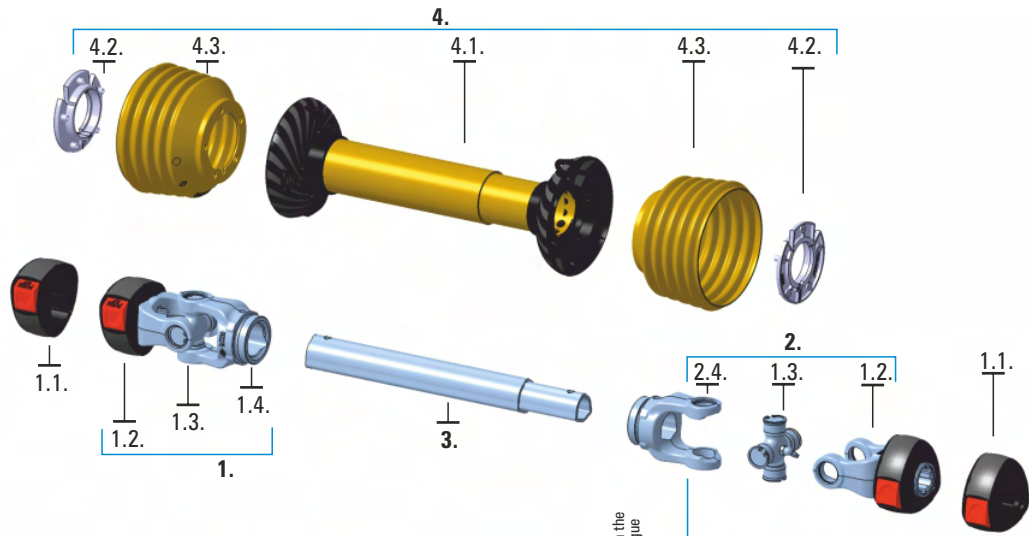

NO.	DESCRIPTION	Page in the Catalogue
1.	Joint C Line 4 BR TZ	95
1.1.	Cover C Line 4	112
1.2.	Outer yoke C Line 4	99
1.3.	Cross C Line 4	98
1.4.	Tube yoke C Line 4 TN	100
2.	Joint C Line 4 BR TN	95
1.1.	Cover C Line 4	112
1.2.	Outer yoke C Line 4	99
1.3.	Cross C Line 4	98
2.4.	Tube yoke C Line 4 TN	100
2.B.	Joint C Line 4 PS TN / C Line 4 PSL TN	95
2.2.2.	Clutch C Line 4 PS / C Line 4 PSL	101
1.3.	Cross C Line 4	98
2.4.	Tube yoke C Line 4 TN	100
2.C.	Joint C Line 4 VS1 TN	95
2.2.3.	Clutch C Line 4 VS1	103
2.3.	Cross C Line 4	98
2.4.	Tube yoke C Line 4 TN	100
2.D.	Joint C Line 4 ST TN	95
2.2.4.	Clutch C Line 4 ST	105
1.3.	Cross C Line 4	98
2.4.	Tube yoke C Line 4 TN	100
2.E.	Joint C Line 4 TS TN	95
2.2.5.	Clutch C Line 4 TS	106
1.3.	Cross C Line 4	98
2.4.	Tube yoke C Line 4 TN	100
3.	Metal tube 4 kpl	109
4.	Safety shield C Line 4	115
4.1.	Safety tube with housing C Line 4	121
4.2.	Shield bearing PA C Line 4	118
4.3.	Cone C Line 4	118
	Chain Type C Line	118

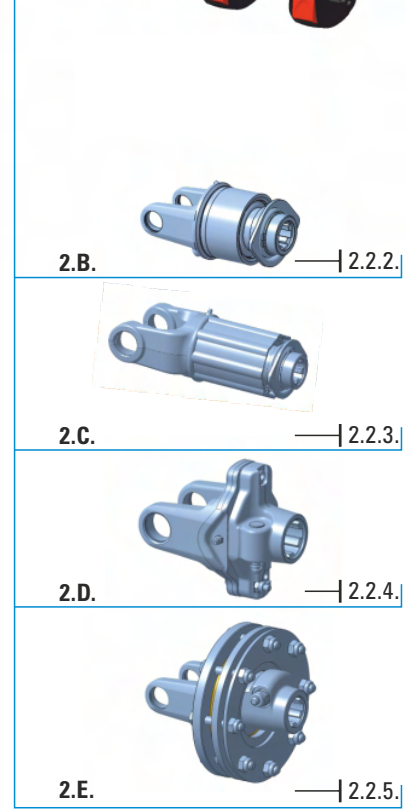

C Line 6

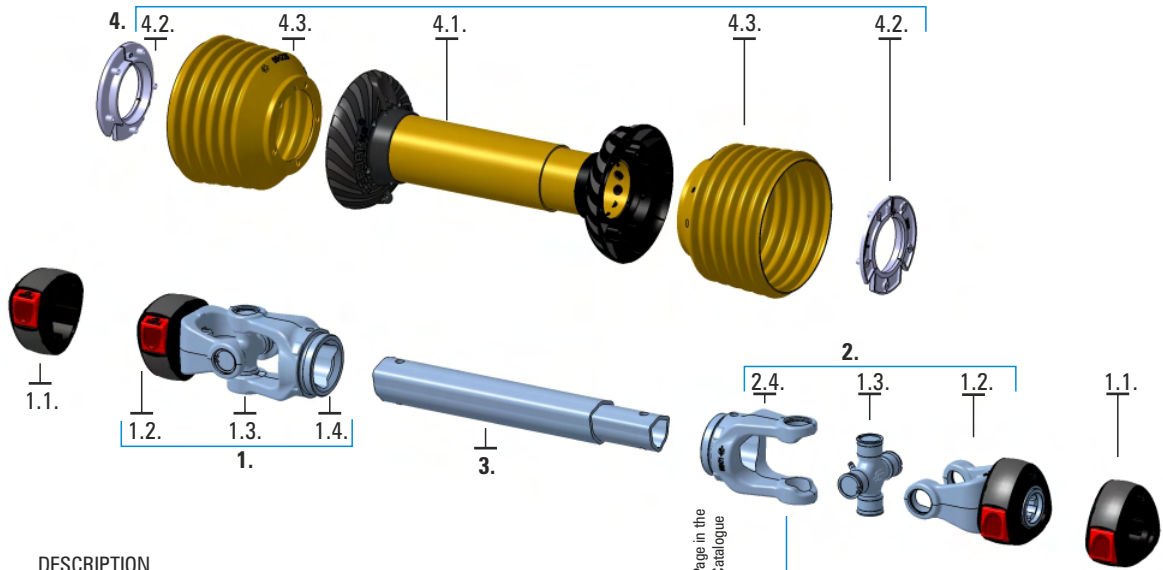

NO.	DESCRIPTION	Page in the Catalogue
1.	Joint C Line 6 BR TZ	96
1.1.	Cover C Line 6	112
1.2.	Outer yoke C Line 6	99
1.3.	Cross C Line 6	98
1.4.	Tube yoke C Line 6 TZ	100
2.	Joint C Line 6 BR TN	96
1.1.	Cover C Line 6	112
1.2.	Outer yoke C Line 6	99
1.3.	Cross C Line 6	98
2.4.	Tube yoke C Line 6 TN	100
2.B.	Joint C Line 6 PS TN / C Line 6 PSL TN	96
2.2.2.	Clutch C Line 6 PS / C Line 6 PSL	101
1.3.	Cross C Line 6	98
2.4.	Tube yoke C Line 6 TN	100
2.C.	Joint C Line 6 VS TN	96
2.2.3.	Clutch C Line 6 VS	104
1.3.	Cross C Line 6	98
2.4.	Tube yoke C Line 6 TN	100
2.D.	Joint C Line 6 ST TN	96
2.2.4.	Clutch C Line 6 ST	105
1.3.	Cross C Line 6	98
2.4.	Tube yoke C Line 6 TN	100
2.E.	Joint C Line 6 TS TN	96
2.2.5.	Clutch C Line 6 TS	106
1.3.	Cross C Line 6	98
2.4.	Tube yoke C Line 6 TN	100
3.	Metal tube 6 kpl	110
4.	Safety shield C Line 6	116
4.1.	Safety tube with housing C Line 6	122
4.2.	Shield bearing PA C Line 6	118
4.3.	Cone C Line 6	118
	Chain Type C Line	118

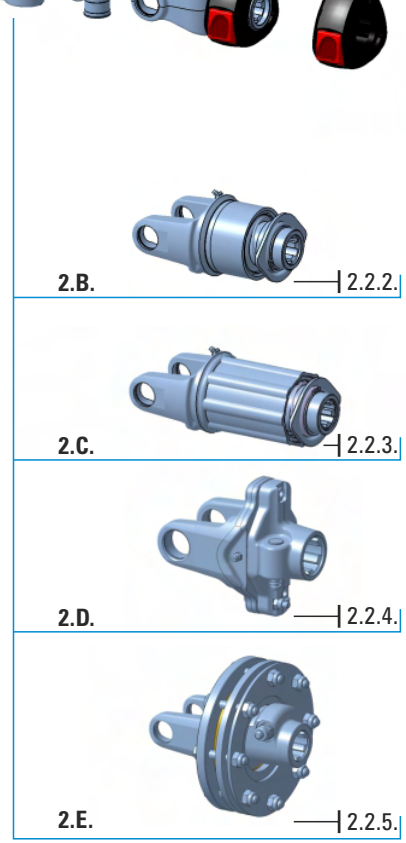

SPARE PARTS PTO DRIVE SHAFTS

C Line 8

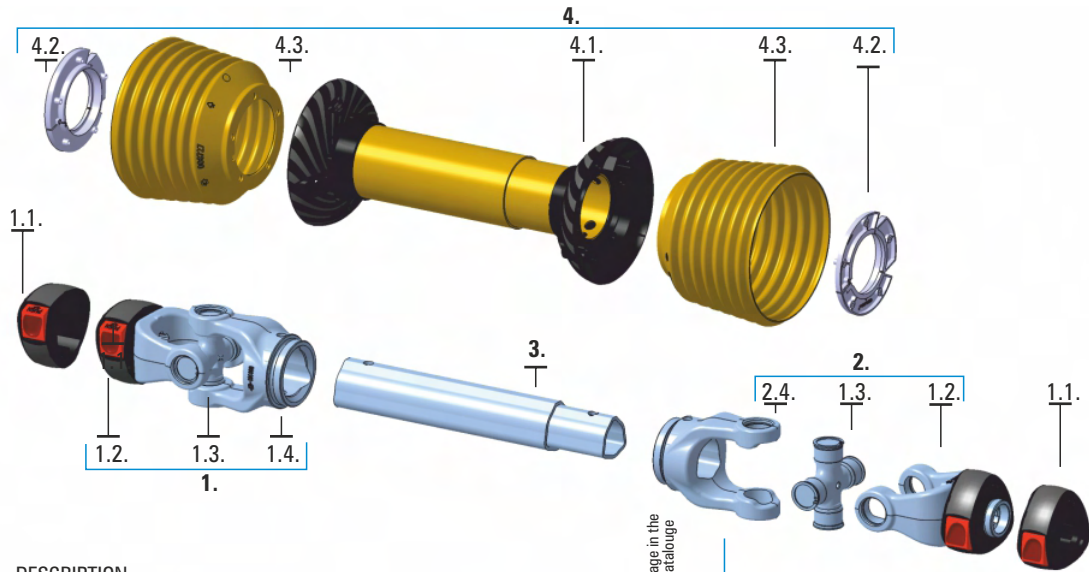

NO.	DESCRIPTION	Page in the Catalogue
1.	Joint C Line 8 BR TZ	97
1.1.	Cover C Line 8	112
1.2.	Outer yoke C Line 8	99
1.3.	Cross C Line 8	98
1.4.	Tube yoke C Line 8 TZ	100
2.	Joint C Line 8 BR TN	97
1.1.	Cover C Line 8	112
1.2.	Outer yoke C Line 8	99
1.3.	Cross C Line 8	98
2.4.	Tube yoke C Line 8 TN	100
2.B.	Joint C Line 8 PS TN / C Line 8 PSL TN	97
2.2.2.	Clutch C Line 8 PS / C Line 8 PSL	101
1.3.	Cross C Line 8	98
2.4.	Tube yoke C Line 8 TN	100
2.C.	Joint C Line 8 VS TN	97
2.2.3.	Clutch C Line 8 VS	104
1.3.	Cross C Line 8	98
2.4.	Tube yoke C Line 8 TN	100
2.D.	Joint C Line 8 ST TN	97
2.2.4.	Clutch C Line 8 ST	105
1.3.	Cross C Line 8	98
2.4.	Tube yoke C Line 8 TN	100
2.E.	Joint C Line 8 TS TN	97
2.2.5.	Clutch C Line 8 TS	106
1.3.	Cross C Line 8	98
2.4.	Tube yoke C Line 8 TN	100
3.	Metal tube 8 kpl	111
4.	Safety shield C Line 8	117
4.1.	Safety tube with housing C Line 8	123
4.2.	Shield bearing PA C Line 8	118
4.3.	Cone C Line 8	118
	Chain Type C Line	118

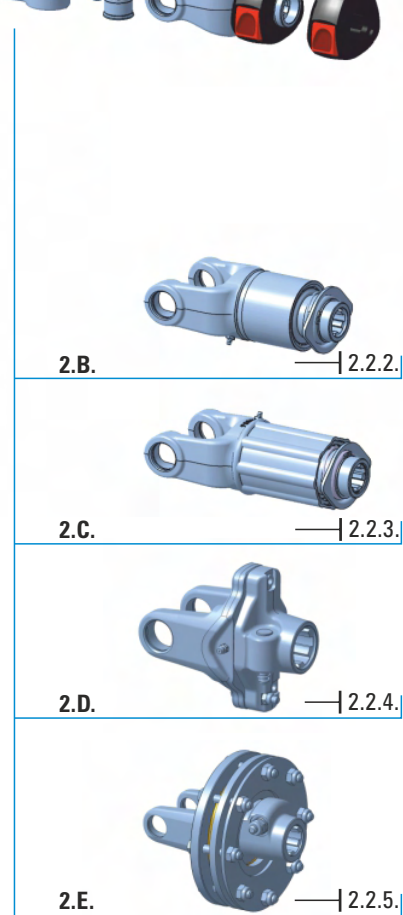

SPARE PARTS PTO DRIVE SHAFTS JOINT 1

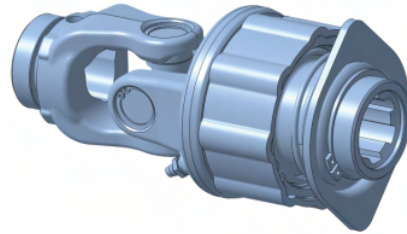
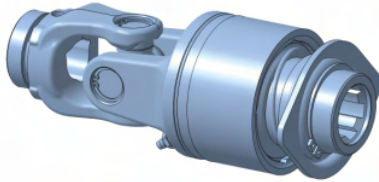
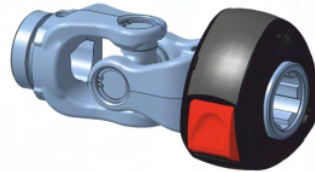

1 3/8"z6

ARTICLE DESCRIPTION

007169R C Line 1 BR+ TN 1 3/8"z6



3831111020925



002875R C Line 1 BR TZ 1 3/8"z6



3831111016300



006865R C Line 1 PS TN 1 3/8"z6



3831111018656



006911R C Line 1 PSL TN 1 3/8"z6



3831111019097



006948R C Line 1 VS1 300Nm TN 1 3/8"z6



3831111019455



006949R C Line 1 VS1 450Nm TN 1 3/8"z6



3831111019462



SPARE PARTS PTO DRIVE SHAFTS

JOINT 2

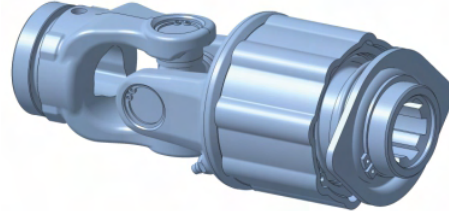
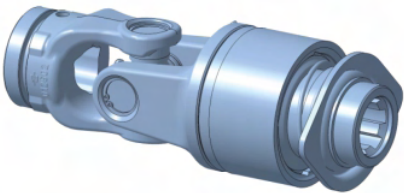

1 3/8"z6

ARTICLE DESCRIPTION

EAN 13 BAR CODE

ARTICLE	DESCRIPTION		EAN 13 BAR CODE
018471R	C Line 2 BR+ TN 1 3/8"z6		3831111094858
012605R	C Line 2 BR TZ 1 3/8"z6		3831111041685
018761R	C Line 2 PS TN 1 3/8"z6		3831111095602
018766R	C Line 2 PSL TN 1 3/8"z6		3831111095633
018770R	C Line 2 VS1 450Nm TN 1 3/8"z6		3831111095664
018772R	C Line 2 VS1 600Nm TN 1 3/8"z6		3831111095688

SPARE PARTS PTO DRIVE SHAFTS JOINT 4

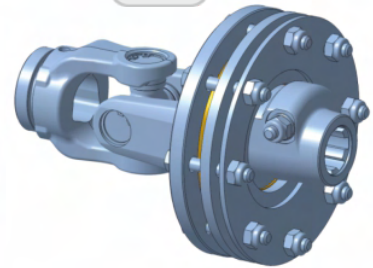
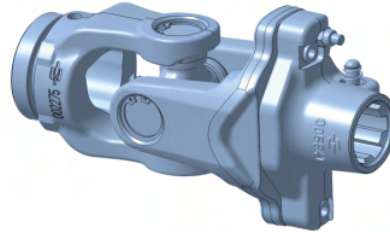
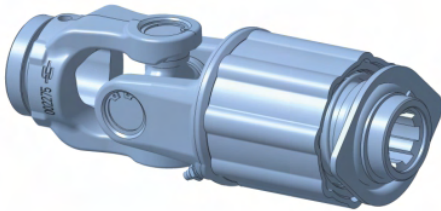
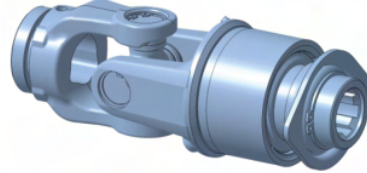
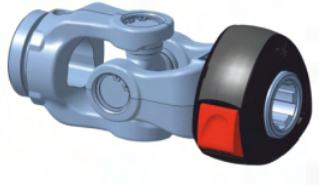

1 3/8"z6

ARTICLE	DESCRIPTION		EAN 13 BAR CODE	
007185R	C Line 4 BR+ TN 1 3/8"z6		3831111021083	
002877R	C Line 4 BR TZ 1 3/8"z6		3831111016522	
006695R	C Line 4 PS TN 1 3/8"z6		3831111016546	
006711R	C Line 4 PSL TN 1 3/8"z6		3831111016676	
006727R	C Line 4 VS1 600Nm TN 1 3/8"z6		3831111016836	
006743R	C Line 4 VS1 900Nm TN 1 3/8"z6		3831111017017	
006759R	C Line 4 ST 900Nm TN 1 3/8"z6		3831111017178	
024291R	C Line 4 ST 1300Nm TN 1 3/8"z6		3838433008723	
006775R	C Line 4 ST 1700Nm TN 1 3/8"z6		3831111017338	
006799R	C Line 4 TS 800Nm TN 1 3/8"z6		3831111017529	

SPARE PARTS PTO DRIVE SHAFTS

JOINT 6

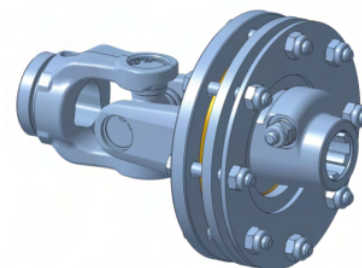
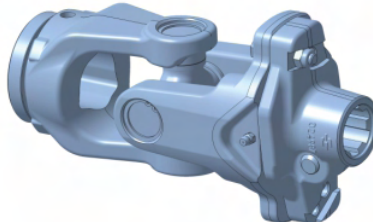
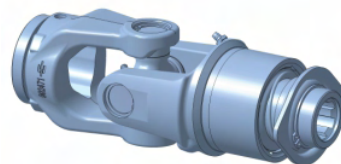
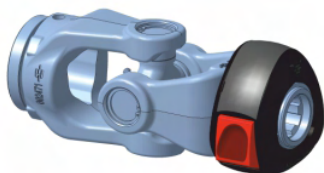

1 3/8"z6

ARTICLE DESCRIPTION

EAN 13 BAR CODE

007206R	C Line 6 BR+ TN 1 3/8"z6		383111021243	
002879R	C Line 6 BR TZ 1 3/8"z6		383111016539	
006827R	C Line 6 PS TN 1 3/8"z6		383111017826	
006862R	C Line 6 PSL TN 1 3/8"z6		383111018625	
006896R	C Line 6 VS1 1200Nm TN 1 3/8"z6		383111017987	
006898R	C Line 6 VS1 1500Nm TN 1 3/8"z6		383111018960	
025630R	C Line 6 ST 1700Nm TN 1 3/8" z6		3838433011075	
025933R	C Line 6 ST 2000Nm TN 1 3/8" z6		3838433011297	
034134R	C Line 6 ST 2400Nm TN 1 3/8" z6		3838433045841	
006947R	C Line 6 ST 2700Nm TN 1 3/8"z6		383111019448	
006900R	C Line 6 TS 1200Nm TN 1 3/8"z6		383111018984	

SPARE PARTS PTO DRIVE SHAFTS JOINT 8

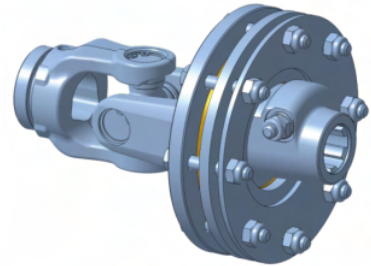
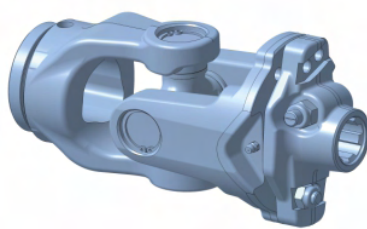
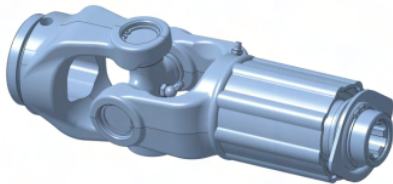
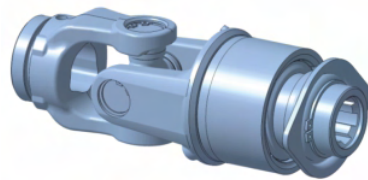
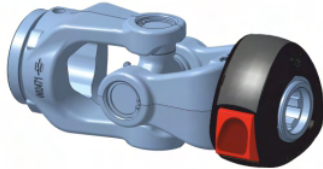

ARTICLE DESCRIPTION

EAN 13 BAR CODE

009692R	C Line 8 BR+ TN 1 3/8"z6		3831111023988		1 3/8"z6
007126R	C Line 8 BR TZ 1 3/8"z6		3831111024862		
009695R	C Line 8 PS TN 1 3/8"z6		3831111024015		
009696R	C Line 8 PSL TN 1 3/8"z6		3831111024022		
009733R	C Line 8 VS1 1200Nm TN 1 3/8"z6		3831111024282		
009734R	C Line 8 VS1 1500Nm TN 1 3/8"z6		3831111024299		
027189R	C line 8 ST 2400Nm TN 1 3/8"z6		3838433012454		
028123R	C line 8 ST 2700Nm TN 1 3/8"z6		3838433012874		
011724R	C Line 8 ST 3000Nm TN 1 3/8"z6		3831111035912		
009697R	C Line 8 ST 3500Nm TN 1 3/8"z6		3831111024039		
004186R	C Line 8 TS 1800Nm TN 1 3/8"z6		3831111035325		
010764R	C Line 8 TS 2600Nm TN 1 3/8"z6		3831111030825		

SPARE PARTS PTO DRIVE SHAFTS

CROSS C Line / KPL

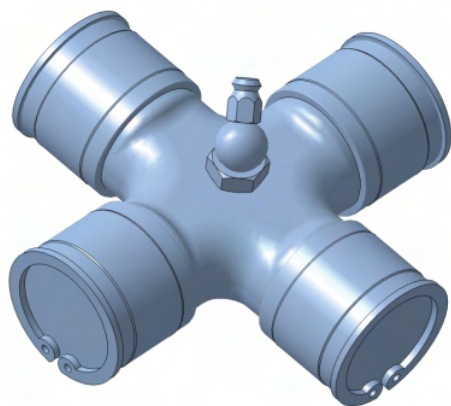

ARTICLE DESCRIPTION

006412R C Line 1 22x55

012789R C Line 2 23,8x61,3

006327R C Line 4 27x74,6

006586R C Line 6 30,2x91,4

009705R C Line 8 35x106

EAN 13 BAR CODE

3831111015273



3831111041739



3831111015051



3831111016140



3831111024084



SPARE PARTS PTO DRIVE SHAFTS OUTER YOKE C Line



ARTICLE	DESCRIPTION	EAN 13 BAR CODE
002640R	C Line 1 1 3/8"z6	3831111019943
006676R	C Line 1 1 3/8"z21	3831111016324
007093R	C Line 1 32/38 z8	3831111020536
012603R	C Line 2 1 3/8"z6	3831111041661
018257R	C Line 2 1 3/8"z21	3831111097064
018258R	C Line 2 32/38 z8	3831111097071
004096R	C Line 4 1 3/8"z6	3831111014672
006677R	C Line 4 1 3/8"z21	3831111017000
007095R	C Line 4 32/38 z8	3831111020567
004181R	C Line 6 1 3/8"z6	3831111015204
006777R	C Line 6 1 3/8"z21	3831111017406
007115R	C Line 6 32/38 z8	3831111020680
008089R	C Line 6 1 3/4"z6	3831111024886
009367R	C Line 6 1 3/4"z20	3831111024909
008088R	C Line 8 1 3/8"z6	3831111024879
009368R	C Line 8 1 3/8"z21	3831111024916
009370R	C Line 8 32/38 z8	3831111024930
008090R	C Line 8 1 3/4"z6	3831111024893
009369R	C Line 8 1 3/4"z20	3831111024923



SPARE PARTS PTO DRIVE SHAFTS
TUBE YOKE C Line



ARTICLE	DESCRIPTION		EAN 13 BAR CODE
002643R	C Line 1 TZ		3831111000873
002644R	C Line 1 TN		3831111000880
012604R	C Line 2 TZ		3831111041678
012668R	C Line 2 TN		3831111041708
002645R	C Line 4 TZ		3831111000897
002646R	C Line 4 TN		3831111000903
004182R	C Line 6 TZ		3831111015211
004183R	C Line 6 TN		3831111015228
008095R	C Line 8 TZ		3831111023650
008096R	C Line 8 TN		3831111023643

SPARE PARTS PTO DRIVE SHAFTS CLUTCH C Line PS

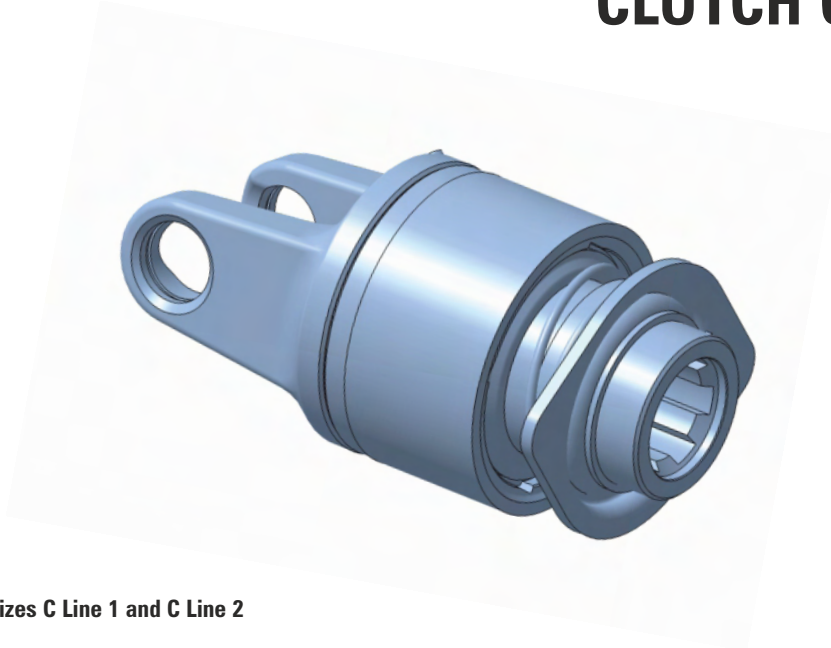

Limited availability for sizes C Line 1 and C Line 2

ARTICLE	DESCRIPTION	EAN 13 BAR CODE
007003R	C Line 1 PS 1 3/8"z6	3831111020062
009706R	C Line 1 PS 1 3/8"z21	3831111024091
009728R	C Line 1 PS 32/38 z8	3831111024237
018762R	C Line 2 PS 1 3/8"z6	3831111095619
019409R	C Line 2 PS 1 3/8"z21	3838433001373
020012R	C Line 2 PS 32/38 z8	3838433001649
007014R	C Line 4 PS 1 3/8"z6	3831111020178
009710R	C Line 4 PS 1 3/8"z21	3831111024114
009729R	C Line 4 PS 32/38 z8	3831111024244
007005R	C Line 6 PS 1 3/8"z6	3831111020086
009716R	C Line 6 PS 1 3/8"z21	3831111024138
009730R	C Line 6 PS 32/38 z8	3831111024251
009718R	C Line 8 PS 1 3/8"z6	3831111024152
009719R	C Line 8 PS 1 3/8"z21	3831111024169
009731R	C Line 8 PS 32/38 z8	3831111024268
009720R	C Line 8 PS 1 3/4"z6	3831111024176
009721R	C Line 8 PS 1 3/4"z20	3831111024183



SPARE PARTS PTO DRIVE SHAFTS

CLUTCH C Line PSL

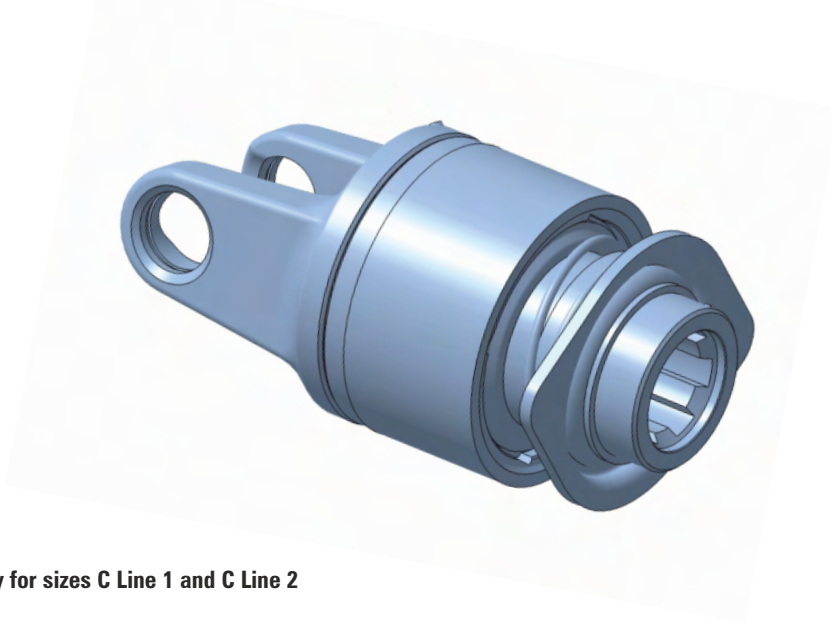

Limited availability for sizes C Line 1 and C Line 2

ARTICLE	DESCRIPTION	EAN 13 BAR CODE
007004R	C Line 1 PSL 1 3/8"z6	3831111020079
009709R	C Line 1 PSL 1 3/8"z21	3831111024107
020013R	C Line 1 PSL 32/38 z8	3838433001397
018765R	C Line 2 PSL 1 3/8"z6	3831111095626
020014R	C Line 2 PSL 1 3/8"z21	3838433001403
020017R	C Line 2 PSL 32/38 z8	3838433001434
007015R	C Line 4 PSL 1 3/8"z6	3831111020185
009712R	C Line 4 PSL 1 3/8"z21	3831111024121
020018R	C Line 4 PSL 32/38 z8	3838433001441
007006R	C Line 6 PSL 1 3/8"z6	3831111020093
009717R	C Line 6 PSL 1 3/8"z21	3831111024145
020019R	C Line 6 PSL 32/38 z8	3838433001458
009722R	C Line 8 PSL 1 3/8"z6	3831111024190
009723R	C Line 8 PSL 1 3/8"z21	3831111024206
009732R	C Line 8 PSL 32/38 z8	3831111024275
009724R	C Line 8 PSL 1 3/4"z6	3831111024213
009725R	C Line 8 PSL 1 3/4"z20	3831111024220



SPARE PARTS PTO DRIVE SHAFTS CLUTCH C Line VS1

Limited availability for sizes C Line 1 and C Line 2

ARTICLE	DESCRIPTION	EAN 13 BAR CODE
007007R	C Line 1 VS1 300Nm 1 3/8"z6	3831111020109
020020R	C Line 1 VS1 300Nm 1 3/8"z21	3838433001465
020021R	C Line 1 VS1 300Nm 32/38 z8	3838433001472
007018R	C Line 1 VS1 450Nm 1 3/8"z6	3831111020215
020022R	C Line 1 VS1 450Nm 1 3/8"z21	3838433001489
020023R	C Line 1 VS1 450Nm 32/38 z8	3838433001496
018769R	C Line 2 VS1 450Nm 1 3/8"z6	3831111095657
020024R	C Line 2 VS1 450Nm 1 3/8"z21	3838433001502
020025R	C Line 2 VS1 450Nm 32/38 z8	3838433001519
018771R	C Line 2 VS1 600Nm 1 3/8"z6	3831111095671
020026R	C Line 2 VS1 600Nm 1 3/8"z21	3838433001526
020027R	C Line 2 VS1 600Nm 32/38 z8	3838433001533
007000R	C Line 4 VS1 600Nm 1 3/8"z6	3831111020031
020028R	C Line 4 VS1 600Nm 1 3/8"z21	3838433001540
020029R	C Line 4 VS1 600Nm 32/38 z8	3838433001557
007017R	C Line 4 VS1 900Nm 1 3/8"z6	3831111020208
020030R	C Line 4 VS1 900Nm 1 3/8"z21	3838433001564
020031R	C Line 4 VS1 900Nm 32/38 z8	3838433001571
009736R	C Line 6 VS1 900Nm 1 3/8"z6	3831111024312
020032R	C Line 6 VS1 900Nm 1 3/8"z21	3838433001588
020033R	C Line 6 VS1 900Nm 32/38 z8	3838433001595



SPARE PARTS PTO DRIVE SHAFTS

CLUTCH C Line VS1

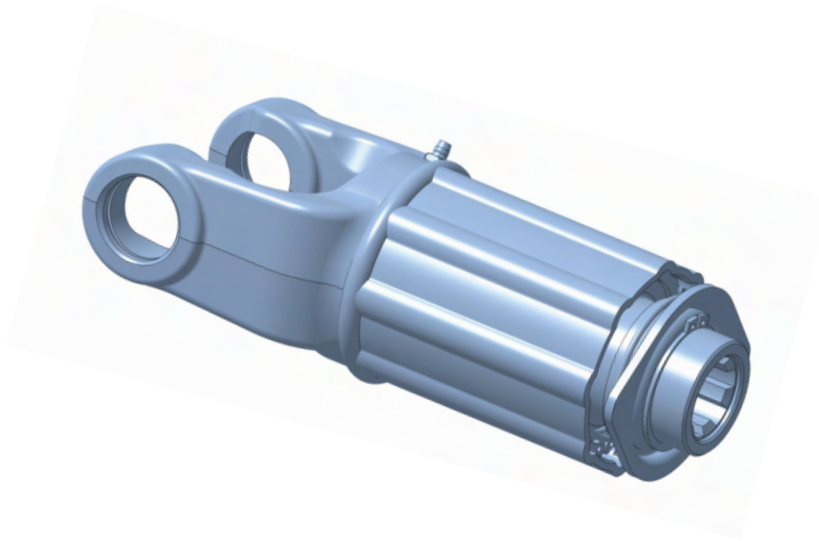

ARTICLE	DESCRIPTION	EAN 13 BAR CODE
009735R	C Line 4 VS1 1200Nm 1 3/8"z6	3831111024305
020034R	C Line 4 VS1 1200Nm 1 3/8"z21	3838433001601
020035R	C Line 4 VS1 1200Nm 32/38 z8	3838433001618
006994R	C Line 6 VS1 1200Nm 1 3/8"z6	3831111019974
020036R	C Line 6 VS1 1200Nm 1 3/8"z21	3838433001625
019990R	C Line 6 VS1 1200Nm 32/38 z8	3838433001106
007008R	C Line 6 VS1 1500Nm 1 3/8"z6	3831111020116
019662R	C Line 6 VS1 1500Nm 1 3/8"z21	3838433000369
019991R	C Line 6 VS1 1500Nm 32/38 z8	3838433001144
009693R	C Line 8 VS1 1500Nm 1 3/8"z6	3831111023995
020037R	C Line 8 VS1 1500Nm 1 3/8"z21	3838433001632
019992R	C Line 8 VS1 1500Nm 32/38 z8	3838433001151

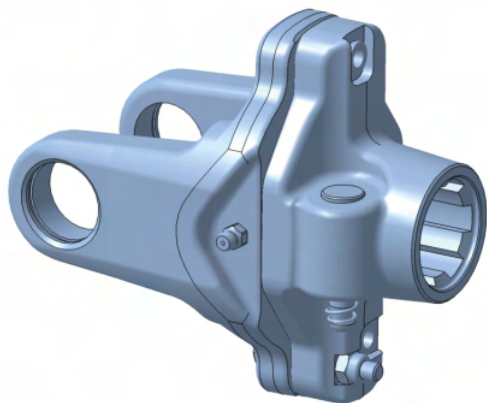

SPARE PARTS PTO DRIVE SHAFTS CLUTCH C Line ST

ARTICLE	DESCRIPTION	EAN 13 BAR CODE
007009R	C Line 4 ST 900Nm 1 3/8"z6	3831111020123
025331R	C Line 4 ST 1300Nm 1 3/8"z6	3838433047548
007010R	C Line 4 ST 1700Nm 1 3/8"z6	3831111020130
024994R	C Line 6 ST 1700Nm 1 3/8" z6	3838433011051
025288R	C Line 6 ST 1700Nm 1 3/8" z21	3838433045735
025287R	C Line 6 ST 1700Nm 1 3/4" z20	3838433011167
025290R	C Line 6 ST 2000Nm 1 3/8" z6	3838433011877
025296R	C Line 6 ST 2400Nm 1 3/8" z6	3838433045810
025302R	C Line 6 ST 2400Nm 1 3/4" z6	3838433046145
025930R	C Line 6 ST 2400Nm 1 3/4" z20	3838433011273
007011R	C Line 6 ST 2700Nm 1 3/8"z6	3831111020147
009738R	C Line 6 ST 2700Nm 1 3/4"z6	3831111024336
009740R	C Line 6 ST 2700Nm 1 3/4"z20	3831111024343
025013R	C Line 8 ST 2400Nm 1 3/8" z6	3838433012423
025312R	C Line 8 ST 2400Nm 1 3/4" z20	3838433047128
025315R	C Line 8 ST 2700Nm 1 3/8" z6	3838433047531
003035R	C Line 8 ST 3000Nm 1 3/8"z6	3831111008602
019195R	C Line 8 ST 3000Nm 1 3/8"z21	3831111097712
003036R	C Line 8 ST 3000Nm 1 3/4"z6	3831111008619
019145R	C Line 8 ST 3000Nm 1 3/4"z20	3831111097217
009741R	C Line 8 ST 3500Nm 1 3/8"z6	3831111024350
010736R	C Line 8 ST 3500Nm 1 3/8"z21	3831111030559
009742R	C Line 8 ST 3500Nm 1 3/4"z6	3831111024367
009743R	C Line 8 ST 3500Nm 1 3/4"z20	3831111024374



SPARE PARTS PTO DRIVE SHAFTS

CLUTCH C Line TS

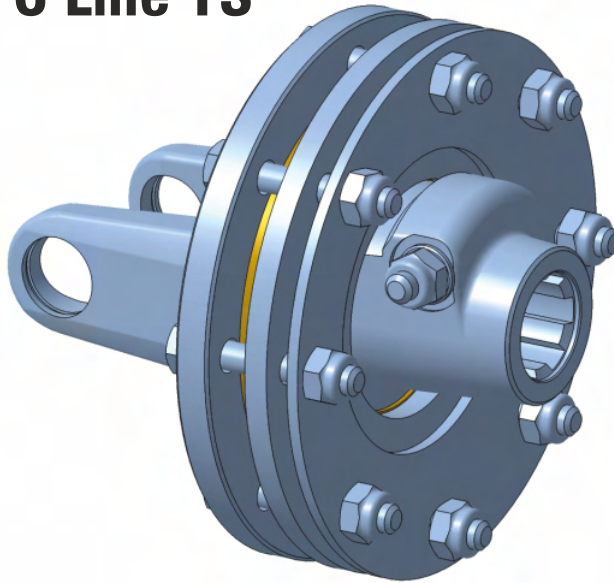

ARTICLE	DESCRIPTION	EAN 13 BAR CODE
007012R	C Line 4 TS 800Nm 1 3/8"z6	3831111020154 
007104R	C Line 6 TS 900Nm 1 3/8"z6	3831111020628 
007013R	C Line 6 TS 1200Nm 1 3/8"z6	3831111020161 
008980R	C Line 6 TS 1200Nm 1 3/4"z6	3831111023032 
018997R	C Line 6 TS 1450Nm 1 3/4"z6	3831111096883 
003054R	C Line 8 TS 1800Nm 1 3/8"z6	3831111008626 
003055R	C Line 8 TS 1800Nm 1 3/4"z6	3831111008671 
019244R	C Line 8 TS 1800Nm 1 3/4"z20	3831111098207 
009744R	C Line 8 TS 2000Nm 1 3/8"z6	3831111024381 
010746R	C Line 8 TS 2000Nm 1 3/8"z21	3831111030641 
009745R	C Line 8 TS 2000Nm 1 3/4"z6	3831111024398 
010747R	C Line 8 TS 2000Nm 1 3/4"z20	3831111030658 
019003R	C Line 8 TS 2500Nm 1 3/4"z6	3831111096944 
010760R	C Line 8 TS 2600Nm 1 3/8"z6	3831111030788 
010761R	C Line 8 TS 2600Nm 1 3/8"z21	3831111030795 
010762R	C Line 8 TS 2600Nm 1 3/4"z6	3831111030801 
010763R	C Line 8 TS 2600Nm 1 3/4"z20	3831111030818 

SPARE PARTS PTO DRIVE SHAFTS
METAL TUBE C Line 1 / KPL

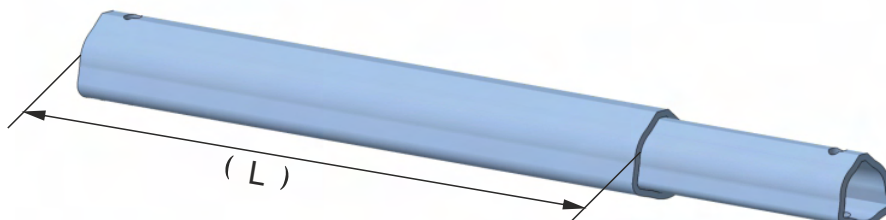

ARTICLE	DESCRIPTION	EAN 13 BAR CODE
006448R	1 kpl za kk510 (395)	3831111018199
006451R	1 kpl za kk560 (445)	3831111018205
006452R	1 kpl za kk610 (495)	3831111018212
006453R	1 kpl za kk660 (545)	3831111018229
006454R	1 kpl za kk710 (595)	3831111018236
006533R	1 kpl za kk760 (645)	3831111018243
006534R	1 kpl za kk810 (695)	3831111018250
006535R	1 kpl za kk860 (745)	3831111018267
006413R	1 kpl za kk910 (795)	3831111018182
006537R	1 kpl za kk960 (845)	3831111018274
006539R	1 kpl za kk1010 (895)	3831111018281
006541R	1 kpl za kk1110 (995)	3831111018298
006543R	1 kpl za kk1210 (1095)	3831111018304
006545R	1 kpl za kk1310 (1195)	3831111018311
006547R	1 kpl za kk1410 (1295)	3831111018328

SPARE PARTS PTO DRIVE SHAFTS

METAL TUBE C Line 2 / KPL

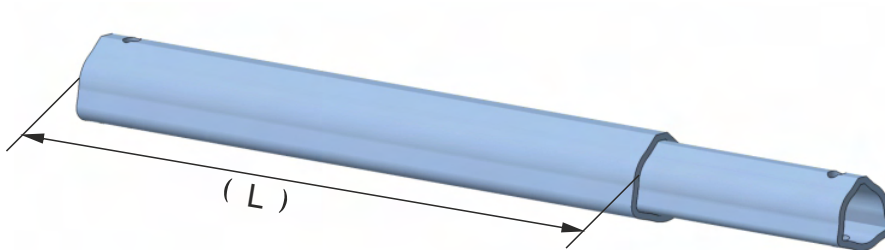

ARTICLE	DESCRIPTION	EAN 13 BAR CODE
018859R	2 kpl za kk510 (385)	3831111095770
018474R	2 kpl za kk560 (435)	3831111094872
018860R	2 kpl za kk610 (485)	3831111095787
018663R	2 kpl za kk660 (535)	3831111095374
018861R	2 kpl za kk710 (585)	3831111095794
018862R	2 kpl za kk760 (635)	3831111095800
018863R	2 kpl za kk810 (685)	3831111095817
018864R	2 kpl za kk860 (735)	3831111095824
012790R	2 kpl za kk910 (785)	3831111041746
018865R	2 kpl za kk960 (835)	3831111095831
018866R	2 kpl za kk1010 (885)	3831111095848
018868R	2 kpl za kk1110 (985)	3831111095855
018869R	2 kpl za kk1210 (1085)	3831111095862
018871R	2 kpl za kk1310 (1185)	3831111095879
018872R	2 kpl za kk1410 (1285)	3831111095886

SPARE PARTS PTO DRIVE SHAFTS
METAL TUBE C Line 4 / KPL

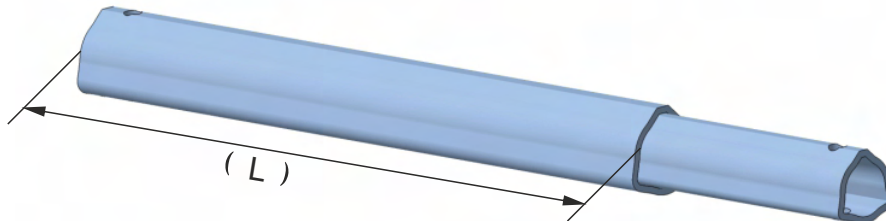

ARTICLE	DESCRIPTION	EAN 13 BAR CODE
006584R	4 kpl za kk510 (370)	3831111018335
006587R	4 kpl za kk560 (420)	3831111018342
006588R	4 kpl za kk610 (470)	3831111018359
006589R	4 kpl za kk660 (520)	3831111018366
006590R	4 kpl za kk710 (570)	3831111018373
006591R	4 kpl za kk760 (620)	3831111018380
006593R	4 kpl za kk810 (670)	3831111018397
006594R	4 kpl za kk860 (720)	3831111018403
006105R	4 kpl za kk910 (770)	3831111018175
006595R	4 kpl za kk960 (820)	3831111018410
006596R	4 kpl za kk1010 (870)	3831111018427
006597R	4 kpl za kk1110 (970)	3831111018434
006598R	4 kpl za kk1210 (1070)	3831111018441
006599R	4 kpl za kk1310 (1170)	3831111018458
006600R	4 kpl za kk1410 (1270)	3831111018465

SPARE PARTS PTO DRIVE SHAFTS

METAL TUBE C Line 6 / KPL

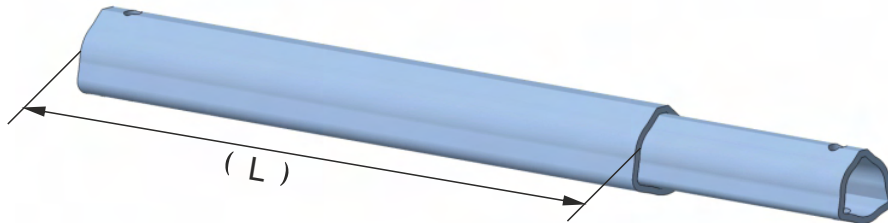

ARTICLE	DESCRIPTION	EAN 13 BAR CODE
006627R	6 kpl za kk560 (385)	3831111018472
006628R	6 kpl za kk610 (435)	3831111018489
006629R	6 kpl za kk660 (485)	3831111018496
006630R	6 kpl za kk710 (535)	3831111018502
006631R	6 kpl za kk760 (585)	3831111018519
006632R	6 kpl za kk810 (635)	3831111018526
006633R	6 kpl za kk860 (685)	3831111018533
006634R	6 kpl za kk910 (735)	3831111018540
006635R	6 kpl za kk960 (785)	3831111018557
006636R	6 kpl za kk1010 (835)	3831111018564
006637R	6 kpl za kk1110 (935)	3831111018571
006638R	6 kpl za kk1210 (1035)	3831111018588
006639R	6 kpl za kk1310 (1135)	3831111018595
006640R	6 kpl za kk1410 (1235)	3831111018601

SPARE PARTS PTO DRIVE SHAFTS
METAL TUBE C Line 8 / KPL

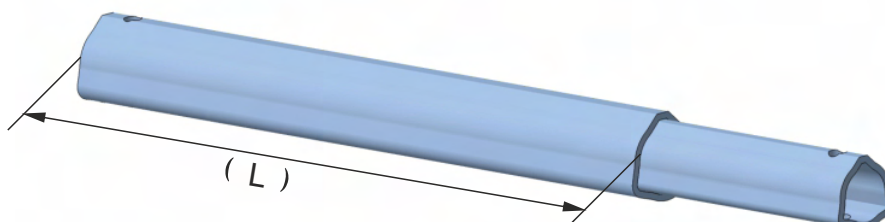

ARTICLE	DESCRIPTION	EAN 13 BAR CODE
009752R	8 kpl za kk560 (360)	3831111024459
009753R	8 kpl za kk610 (410)	3831111024466
009754R	8 kpl za kk660 (460)	3831111024473
009755R	8 kpl za kk710 (510)	3831111024480
009756R	8 kpl za kk760 (560)	3831111024497
009757R	8 kpl za kk810 (610)	3831111024503
009758R	8 kpl za kk860 (660)	3831111024510
009759R	8 kpl za kk910 (710)	3831111024527
009760R	8 kpl za kk960 (760)	3831111024534
009761R	8 kpl za kk1010 (810)	3831111024541
009762R	8 kpl za kk1110 (910)	3831111024558
009763R	8 kpl za kk1210 (1010)	3831111024565
009764R	8 kpl za kk1310 (1110)	3831111024572
009766R	8 kpl za kk1410 (1210)	3831111024596

SPARE PARTS PTO DRIVE SHAFTS

COVER C Line, PUSH-PIN C Line



ARTICLE	DESCRIPTION
006411R	C Line 1
008982R	C Line 1 32/38 z8
018561R	C Line 2
018477R	C Line 2 32/38 z8
006103R	C Line 4
007502R	C Line 4 32/38 z8
006585R	C Line 6
009750R	C Line 6 32/38 z8
008455R	C Line 6 1 3/4"
008452R	C Line 8
009751R	C Line 8 32/38 z8
008456R	C Line 8 1 3/4"

EAN 13 BAR CODE

3831111015266	
3831111023056	
3831111095152	
3831111094896	
3831111015068	
3831111022127	
3831111016133	
3831111024435	
3831111025029	
3831111025012	
3831111024442	
3831111025036	

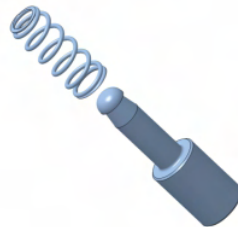

002677R	Push-Pin C Line 1;2;4;6 1 3/8"z6 10 Pcs
009554R	Push-Pin C Line 6;8 1 3/4" 10 Pcs
011720R	Push-Pin C Line 8 1 3/8"z6 10 Pcs
011721R	Push-Pin C Line 8 1 3/8"z21 10 Pcs

3831111001153	
3831111023841	
3831111035882	
3831111035899	

SPARE PARTS PTO DRIVE SHAFTS

SAFETY SHIELD C Line 1 / KPL

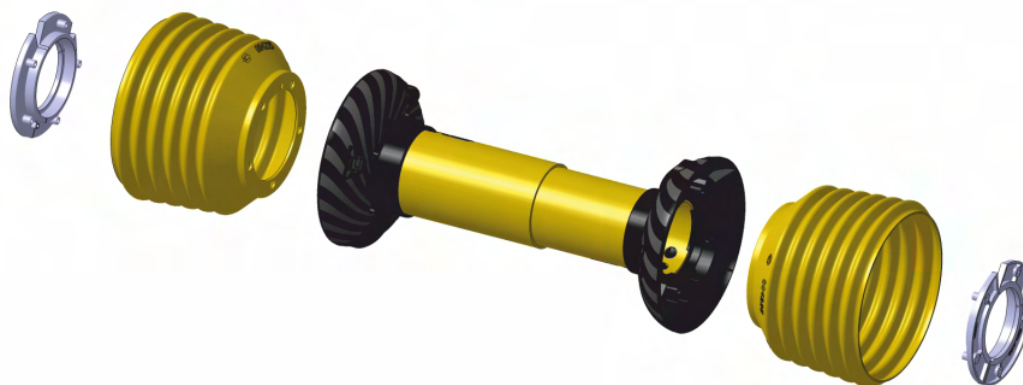

ARTICLE	DESCRIPTION	EAN 13 BAR CODE
006505R	C Line 1 za kk510 (300)	3831111015716
006506R	C Line 1 za kk560 (350)	3831111015723
006507R	C Line 1 za kk610 (400)	3831111015730
006508R	C Line 1 za kk660 (450)	3831111015747
006509R	C Line 1 za kk710 (500)	3831111015754
006510R	C Line 1 za kk760 (550)	3831111015761
006511R	C Line 1 za kk810 (600)	3831111015778
006512R	C Line 1 za kk860 (650)	3831111015785
006414R	C Line 1 za kk910 (700)	3831111015280
006513R	C Line 1 za kk960 (750)	3831111015792
006514R	C Line 1 za kk1010 (800)	3831111015808
006515R	C Line 1 za kk1110 (900)	3831111015815
006516R	C Line 1 za kk1210 (1000)	3831111015822
006517R	C Line 1 za kk1310 (1100)	3831111015839
006518R	C Line 1 za kk1410 (1200)	3831111015846

SPARE PARTS PTO DRIVE SHAFTS

SAFETY SHIELD C Line 2 / KPL



ARTICLE	DESCRIPTION	EAN 13 BAR CODE
018886R	C Line 2 za kk510 (290)	3831111096012
018472R	C Line 2 za kk560 (340)	3831111094865
018887R	C Line 2 za kk610 (390)	3831111096029
018888R	C Line 2 za kk660 (440)	3831111096036
018744R	C Line 2 za kk710 (490)	3831111095541
018889R	C Line 2 za kk760 (540)	3831111096043
018891R	C Line 2 za kk810 (590)	3831111096050
018892R	C Line 2 za kk860 (640)	3831111095749
012792R	C Line 2 za kk910 (690)	3831111041760
018893R	C Line 2 za kk960 (740)	3831111096074
018894R	C Line 2 za kk1010 (790)	3831111096081
018895R	C Line 2 za kk1110 (890)	3831111096098
018896R	C Line 2 za kk1210 (990)	3831111096104
018897R	C Line 2 za kk1310 (1090)	3831111096111
018898R	C Line 2 za kk1410 (1190)	3831111096128

SPARE PARTS PTO DRIVE SHAFTS
SAFETY SHIELD C Line 4 / KPL



ARTICLE	DESCRIPTION	EAN 13 BAR CODE
006519R	C Line 4 za kk510 (270)	3831111015853
006520R	C Line 4 za kk560 (320)	3831111015860
006521R	C Line 4 za kk610 (370)	3831111015877
006522R	C Line 4 za kk660 (420)	3831111015884
006523R	C Line 4 za kk710 (470)	3831111015891
006524R	C Line 4 za kk760 (520)	3831111015907
006525R	C Line 4 za kk810 (570)	3831111015914
006526R	C Line 4 za kk860 (620)	3831111015921
006104R	C Line 4 za kk910 (670)	3831111015044
006527R	C Line 4 za kk960 (720)	3831111015938
006528R	C Line 4 za kk1010 (770)	3831111015945
006529R	C Line 4 za kk1110 (870)	3831111015952
006530R	C Line 4 za kk1210 (970)	3831111015969
006531R	C Line 4 za kk1310 (1070)	3831111015976
006532R	C Line 4 za kk1410 (1170)	3831111015983

SPARE PARTS PTO DRIVE SHAFTS

SAFETY SHIELD C Line 6 / KPL



ARTICLE	DESCRIPTION	EAN 13 BAR CODE
006538R	C Line 6 za kk560 (280)	3831111015990
006540R	C Line 6 za kk610 (330)	3831111016003
006542R	C Line 6 za kk660 (380)	3831111016010
006544R	C Line 6 za kk710 (430)	3831111016027
006546R	C Line 6 za kk760 (480)	3831111016034
006548R	C Line 6 za kk810 (530)	3831111016041
006549R	C Line 6 za kk860 (580)	3831111016058
006550R	C Line 6 za kk910 (630)	3831111016065
006551R	C Line 6 za kk960 (680)	3831111016072
006552R	C Line 6 za kk1010 (730)	3831111016089
006553R	C Line 6 za kk1110 (830)	3831111016096
006554R	C Line 6 za kk1210 (930)	3831111016102
006555R	C Line 6 za kk1310 (1030)	3831111016119
006556R	C Line 6 za kk1410 (1130)	3831111016126

SPARE PARTS PTO DRIVE SHAFTS

SAFETY SHIELD C Line 8 / KPL



ARTICLE	DESCRIPTION	EAN 13 BAR CODE
009778R	C Line 8 za kk560 (240)	3831111024602
009779R	C Line 8 za kk610 (290)	3831111024619
009780R	C Line 8 za kk660 (340)	3831111024626
009781R	C Line 8 za kk710 (390)	3831111024633
009782R	C Line 8 za kk760 (440)	3831111024640
009783R	C Line 8 za kk810 (490)	3831111024657
009784R	C Line 8 za kk860 (540)	3831111024664
009787R	C Line 8 za kk910 (590)	3831111024688
009788R	C Line 8 za kk960 (640)	3831111024695
009789R	C Line 8 za kk1010 (690)	3831111024701
009790R	C Line 8 za kk1110 (790)	3831111024718
009791R	C Line 8 za kk1210 (890)	3831111024725
009792R	C Line 8 za kk1310 (990)	3831111024732
009793R	C Line 8 za kk1410 (1090)	3831111024749

SPARE PARTS PTO DRIVE SHAFTS

PARTS OF PROTECTION



ARTICLE	DESCRIPTION
004226R	C Line 1
018560R	C Line 2
003298R	C Line 4
004190R	C Line 6
008730R	C Line 8

EAN 13 BAR CODE

3831111020260	
3831111095145	
3831111020239	
3831111020246	
3831111023964	



ARTICLE	DESCRIPTION
004224R	C Line 1
018562R	C Line 2
003303R	C Line 4
004225R	C Line 6
008727R	C Line 8

EAN 13 BAR CODE

3831111020253	
3831111095169	
3831111015198	
3831111015235	
3831111023957	



ARTICLE	DESCRIPTION
006097R	Type C Line

EAN 13 BAR CODE

3831111020277	
---------------	--

SAFETY TUBE WITH HOUSING C Line 1

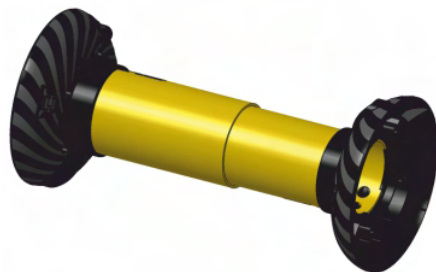

ARTICLE	DESCRIPTION	EAN 13 BAR CODE
006328R	C Line 1 za kk510 (300)	3831111015242
006409R	C Line 1 za kk910 (700)	3831111015259
006415R	C Line 1 za kk560 (350)	3831111015297
006455R	C Line 1 za kk610 (400)	3831111015310
006456R	C Line 1 za kk660 (450)	3831111015327
006457R	C Line 1 za kk710 (500)	3831111015334
006458R	C Line 1 za kk760 (550)	3831111015341
006459R	C Line 1 za kk810 (600)	3831111015358
006460R	C Line 1 za kk860 (650)	3831111015365
006461R	C Line 1 za kk960 (750)	3831111015372
006462R	C Line 1 za kk1010 (800)	3831111015389
006463R	C Line 1 za kk1110 (900)	3831111015396
006464R	C Line 1 za kk1210 (1000)	3831111015402
006465R	C Line 1 za kk1310 (1100)	3831111015419
006466R	C Line 1 za kk1410 (1200)	3831111015426

SPARE PARTS PTO DRIVE SHAFTS

SAFETY TUBE WITH HOUSING C Line 2

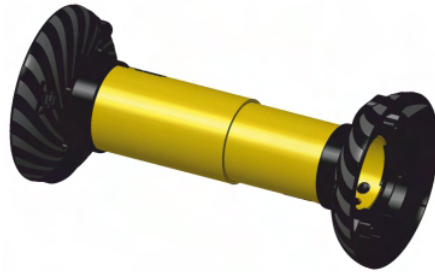

ARTICLE	DESCRIPTION	EAN 13 BAR CODE
018873R	C Line 2 za kk510 (290)	3831111095893
018470R	C Line 2 za kk560 (340)	3831111094841
018874R	C Line 2 za kk610 (390)	3831111095909
018875R	C Line 2 za kk660 (440)	3831111095916
018743R	C Line 2 za kk710 (490)	3831111095534
018876R	C Line 2 za kk760 (540)	3831111095923
018877R	C Line 2 za kk810 (590)	3831111095930
018878R	C Line 2 za kk860 (640)	3831111095947
012754R	C Line 2 za kk910 (690)	3831111041715
018879R	C Line 2 za kk960 (740)	3831111095954
018880R	C Line 2 za kk1010 (790)	3831111095961
018881R	C Line 2 za kk1110 (890)	3831111095978
018882R	C Line 2 za kk1210 (990)	3831111095985
018883R	C Line 2 za kk1310 (1090)	3831111095992
018884R	C Line 2 za kk1410 (1190)	3831111096005

SPARE PARTS PTO DRIVE SHAFTS
SAFETY TUBE WITH HOUSING C Line 4



ARTICLE	DESCRIPTION	EAN 13 BAR CODE
006472R	C Line 4 za kk510 (270)	3831111015433
006473R	C Line 4 za kk560 (320)	3831111015440
006474R	C Line 4 za kk610 (370)	3831111015457
006475R	C Line 4 za kk660 (420)	3831111015464
006476R	C Line 4 za kk710 (470)	3831111015471
006477R	C Line 4 za kk760 (520)	3831111015488
006478R	C Line 4 za kk810 (570)	3831111015495
006479R	C Line 4 za kk860 (620)	3831111015501
006099R	C Line 4 za kk910 (670)	3831111015037
006480R	C Line 4 za kk960 (720)	3831111015518
006481R	C Line 4 za kk1010 (770)	3831111015525
006482R	C Line 4 za kk1110 (870)	3831111015532
006483R	C Line 4 za kk1210 (970)	3831111015549
006484R	C Line 4 za kk1310 (1070)	3831111015556
006485R	C Line 4 za kk1410 (1170)	3831111015563

SPARE PARTS PTO DRIVE SHAFTS

SAFETY TUBE WITH HOUSING C Line 6



ARTICLE	DESCRIPTION	EAN 13 BAR CODE
006491R	C Line 6 za kk560 (280)	3831111015570
006492R	C Line 6 za kk610 (330)	3831111015587
006493R	C Line 6 za kk660 (380)	3831111015594
006494R	C Line 6 za kk710 (430)	3831111015600
006495R	C Line 6 za kk760 (480)	3831111015617
006496R	C Line 6 za kk810 (530)	3831111015624
006497R	C Line 6 za kk860 (580)	3831111015631
006498R	C Line 6 za kk910 (630)	3831111015648
006499R	C Line 6 za kk960 (680)	3831111015655
006500R	C Line 6 za kk1010 (730)	3831111015662
006501R	C Line 6 za kk1110 (830)	3831111015679
006502R	C Line 6 za kk1210 (930)	3831111015686
006503R	C Line 6 za kk1310 (1030)	3831111015693
006504R	C Line 6 za kk1410 (1130)	3831111015709

SPARE PARTS PTO DRIVE SHAFTS

SAFETY TUBE WITH HOUSING C Line 8

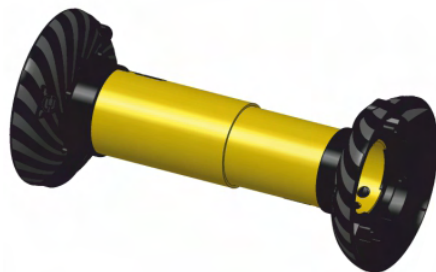

ARTICLE	DESCRIPTION	EAN 13 BAR CODE
009795R	C Line 8 za kk510 (190)	3831111024756
009796R	C Line 8 za kk560 (240)	3831111024763
009797R	C Line 8 za kk610 (290)	3831111024770
009798R	C Line 8 za kk660 (340)	3831111024787
009799R	C Line 8 za kk710 (390)	3831111024794
009800R	C Line 8 za kk760 (440)	3831111024800
009801R	C Line 8 za kk810 (490)	3831111024817
009802R	C Line 8 za kk860 (540)	3831111024824
008733R	C Line 8 za kk910 (590)	3831111023971
009803R	C Line 8 za kk960 (640)	3831111024831
009804R	C Line 8 za kk1010 (690)	3831111024848
009805R	C Line 8 za kk1110 (790)	3831111024855
009806R	C Line 8 za kk1210 (890)	3831111023902
009807R	C Line 8 za kk1310 (990)	3831111023919
009808R	C Line 8 za kk1410 (1090)	3831111023926

SPARE PARTS PTO DRIVE SHAFTS



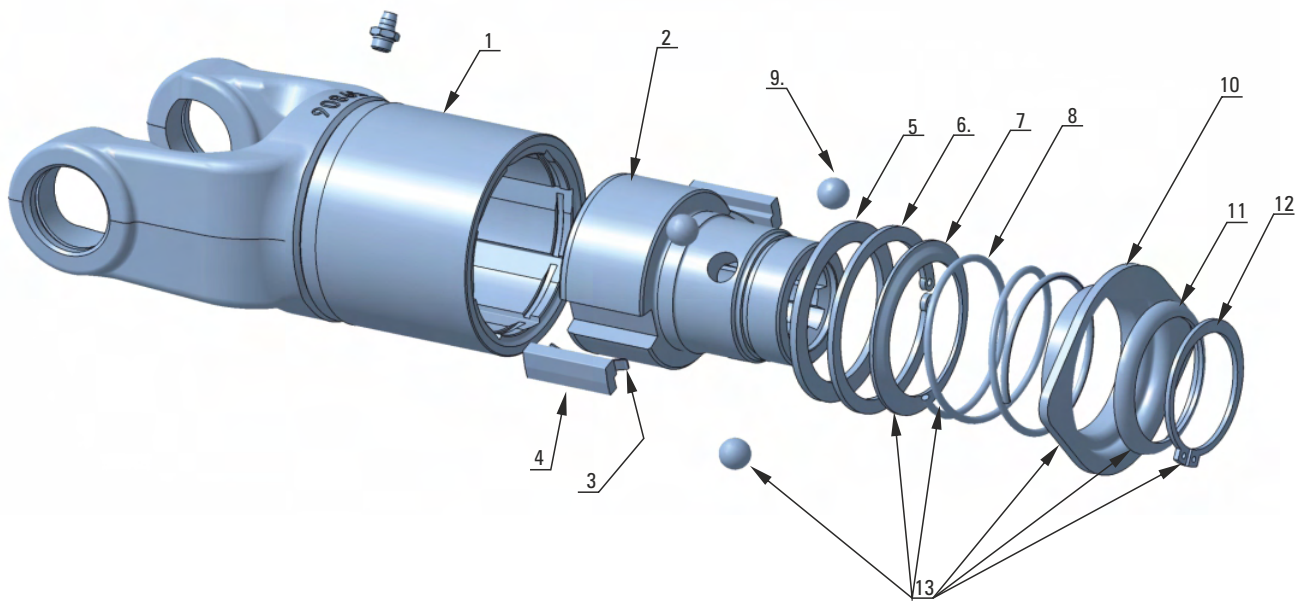





















































CLUTCH PARTS C Line PS / PSL



SPARE PARTS PTO DRIVE SHAFTS

CLUTCH PARTS C Line PS / PSL

Limited availability for sizes C Line 1 and C Line 2

COMPONENTS	ARTICLE	DESCRIPTION			EAN 13 BAR CODE		
1	006289R	Clutch housing C Line 1 PS			3831111014696		
1	006290R	Clutch housing C Line 1 PSL			3831111014702		
1	020008R	Clutch housing C Line 2 PS			3838433001311		
1	020009R	Clutch housing C Line 2 PSL			3838433001328		
1	006291R	Clutch housing C Line 4 PS			3831111014719		
1	006292R	Clutch housing C Line 4 PSL			3831111014726		
1	006293R	Clutch housing C Line 6 PS			3831111014733		
1	006294R	Clutch housing C Line 6 PSL			3831111014740		
2	006295R	Hub C Line PS 1 3/8"z6				3831111014757	
2	006296R	Hub C Line PS 1 3/8"z21				3831111014764	
2	011538R	Hub C Line PS 32/38 z8				3838433001120	
3	006297R	Leaf spring C Line PS				3831111014771	
4	006298R	Key C Line PS				3831111014788	
5	006299R	Supporting ring C Line PS				3831111014795	
6	006300R	Spring ring C Line PS				3831111014801	
7	006301R	Protective Ring C Line PS				3831111014818	
8	007001R	Push Spring C Line				3831111020048	
8	011539R	Push Spring C Line 32/38 z8				3838433001366	
9	006996R	Ball C Line				3831111019998	
10	006999R	Removable plate C Line				3831111020024	
10	004129R	Removable plate C Line 32/38 z8				3838433001342	
11	006997R	Angular ring C Line				3831111020000	
11	004134R	Angular ring C Line 32/38 z8				3838433001359	
12	006306R	Spring ring C Line				3831111014863	
13	006995R	Coupling mechanism C Line				3831111019981	
14	020067R	Coupling mechanisms C Line 32/38 z8				3838433001731	



SPARE PARTS PTO DRIVE SHAFTS

CLUTCH PARTS C Line VS

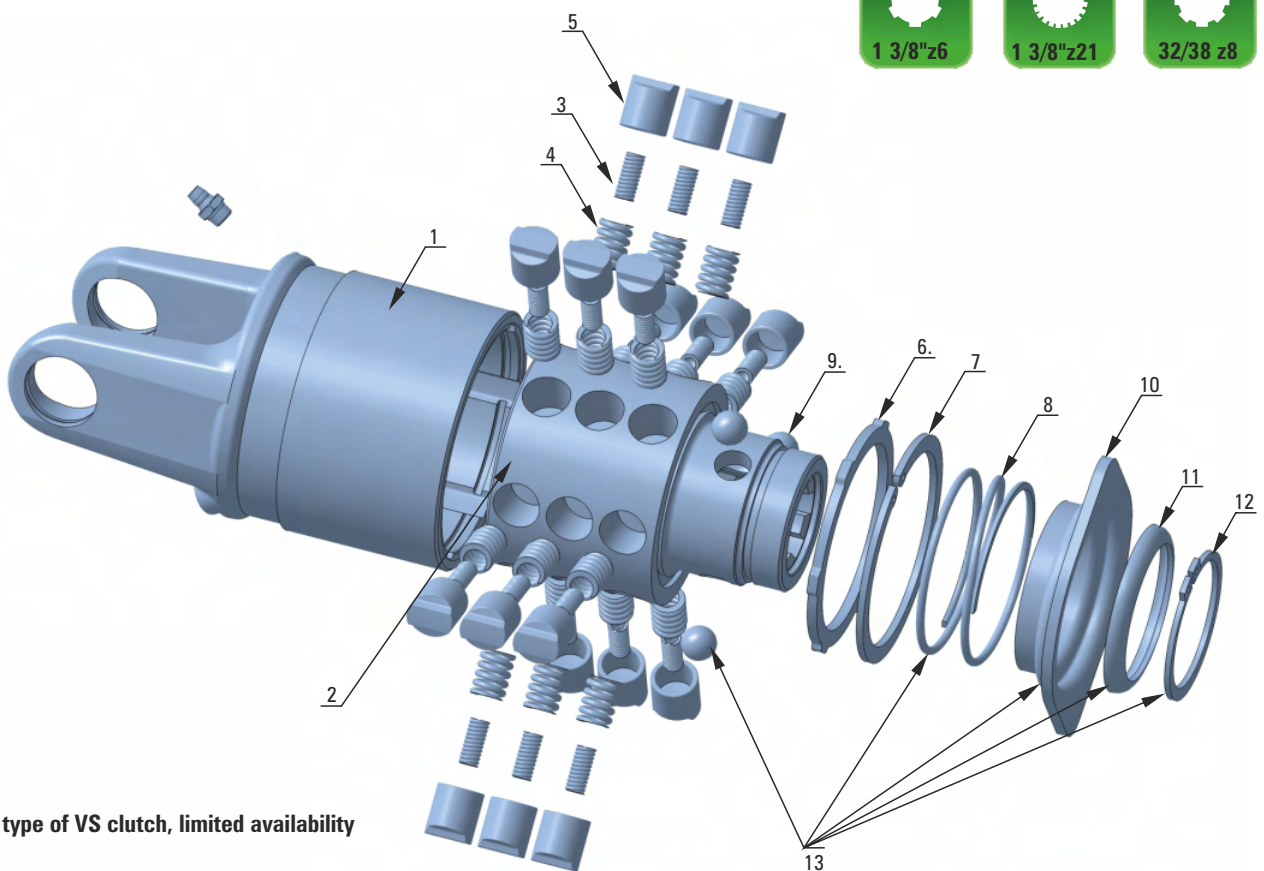

Old type of VS clutch, limited availability

COMPONENTS

ARTICLE	DESCRIPTION		EAN 13 BAR CODE
1 006307R	Clutch housing C Line 1 VS 360Nm	 	3831111014870 
1 020010R	Clutch housing C Line 2 VS 720Nm	 	3838433001335 
1 006308R	Clutch housing C Line 4 VS 720Nm	 	3831111014887 
1 006309R	Clutch housing C Line 4 VS 1080Nm	 	3831111014894 
1 006310R	Clutch housing C Line 4 VS 1440Nm	 	3831111014900 

SPARE PARTS PTO DRIVE SHAFTS

CLUTCH PARTS C Line VS

COMPONENTS

ARTICLE	DESCRIPTION		EAN 13 BAR CODE
2 006311R	Hub C Line VS 360Nm 1 3/8"z6	  1 3/8"z6	3831111014917 
2 020048R	Hub C Line VS 360Nm 1 3/8"z21	  1 3/8"z21	3838433001663 
2 020050R	Hub C Line VS 360Nm 32/38 z8	  32/38 z8	3838433001687 
2 006312R	Hub C Line VS 720Nm 1 3/8"z6	  1 3/8"z6	3831111014924 
2 006313R	Hub C Line VS 720Nm 1 3/8"z21	  1 3/8"z21	3831111014931 
2 020051R	Hub C Line VS 720Nm 32/38 z8	  32/38 z8	3838433001694 
2 006314R	Hub C Line VS 1080Nm 1 3/8"z6	  1 3/8"z6	3831111014948 
2 020049R	Hub C Line VS 1080Nm 1 3/8"z21	  1 3/8"z21	3838433001670 
2 020052R	Hub C Line VS 1080Nm 32/38 z8	  32/38 z8	3838433001700 
3 006315R	Internal spring C Line VS		3831111014955 
4 006316R	External spring C Line VS		3831111014962 
5 006317R	Cam C Line VS		3831111014979 
6 006318R	Closing ring C Line VS		3831111014986 
7 006319R	Spring ring C Line VS		3831111014993 
8 007001R	Push spring C Line		3831111020048 
8 011539R	Push springr C Line 32x38 z8	 32/38 z8	3838433001366 
9 006996R	Ball C Line		3831111019998 
10 006999R	Removable plate C Line		3831111020024 
10 004129R	Removable plate C Line 32x38 z8	 32/38 z8	3838433001342 
11 006997R	Angular ring C Line		3831111020000 
11 004134R	Angular ring C Line 32x38 z8	 32/38 z8	3838433001359 
12 006306R	Spring ring C Line		3831111014863 
13 006995R	Coupling mechanism C Line		3831111019981 
13 020053R	Coupling mechanism C Line VS 32x38 z8	 32/38 z8	3838433001717 



CLUTCH PARTS C Line VS1

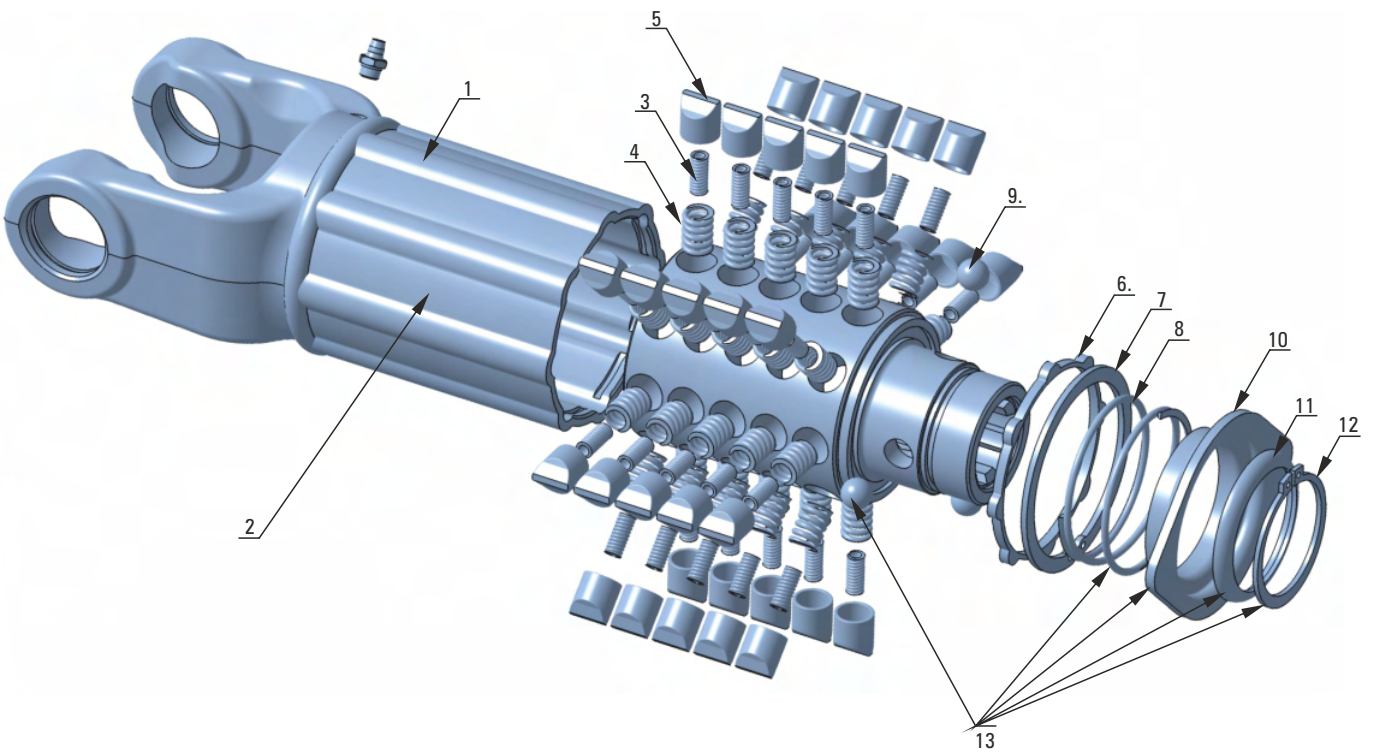

SPARE PARTS PTO DRIVE SHAFTS

CLUTCH PARTS C Line VS1

COMPONENTS

ARTICLE	DESCRIPTION		EAN 13 BAR CODE
1 007322R	Clutch housing C Line 4 VS1 1200Nm	 	3838433001656 
1 006998R	Clutch housing C Line 6 VS1 1200Nm	 	3831111020017 
1 007019R	Clutch housing C Line 6 VS1 1500Nm	 	3831111020222 
1 019099R	Clutch housing C Line 8 VS1 1500Nm	 	3838433000956 
2 007002R	Hub C Line VS1 1200Nm 1 3/8"z6	 	3831111020055 
2 020011R	Hub C Line VS1 1200Nm 1 3/8"z21	 	3838433001380 
2 019982R	Hub C Line VS1 1200Nm 32/38 z8	 	3838433001021 
2 007016R	Hub C Line VS1 1500Nm 1 3/8"z6	 	3831111020192 
2 019663R	Hub C Line VS1 1500Nm 1 3/8"z21	 	3838433000963 
2 019983R	Hub C Line VS1 1500Nm 32/38 z8	 	3838433001038 
3 006315R	Internal spring C Line VS		3831111014955 
4 006316R	External spring C Line VS		3831111014962 
5 007042R	Cam C Line VS1		3831111020451 
6 007306R	Closing ring C Line VS1		3831111097101 
7 006319R	Spring ring C Line VS		3831111014993 
8 007001R	Push spring C Line VS		3831111020048 
8 011539R	Push spring C Line 32x38 z8		3838433001366 
9 006996R	Ball C Line		3831111019998 
10 006999R	Removable plate C Line		3831111020024 
10 004129R	Removable plate C Line 32x38 z8		3838433001342 
11 006997R	Angular ring C Line		3831111020000 
11 004134R	Angular ring C Line 32x38 z8		3838433001359 
12 006306R	Spring ring C Line		3831111014863 
13 020015R	Coupling mechanism C Line VS1		3838433001410 
13 020016R	Coupling mechanism C Line VS1 32x38 z8		3838433001427 



SPARE PARTS PTO DRIVE SHAFTS

CLUTCH PARTS C Line ST

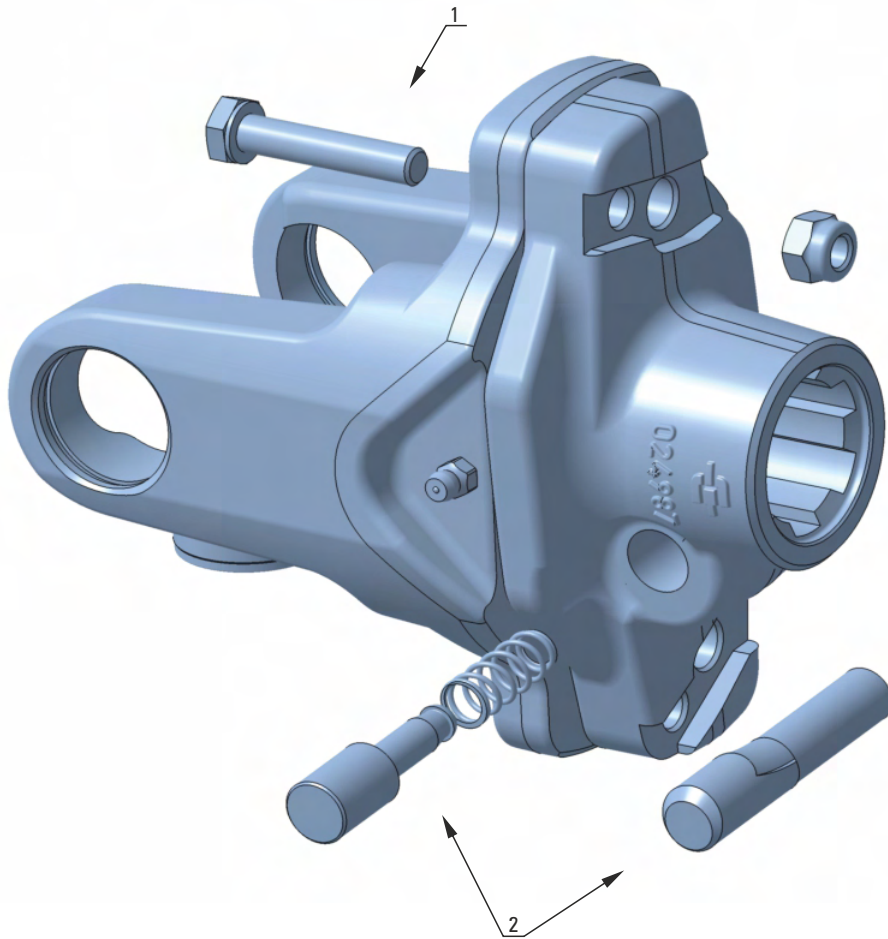

1 3/8"z6



1 3/8"z21



1 3/4"z6



1 3/8"z20

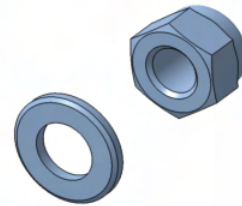

COMPONENTS

ARTICLE DESCRIPTION

1	007020R	Hexagon screw C Line ST M6x40, 8.8	
1	007021R	Hexagon screw C Line ST M8x45, 8.8	
1	007022R	Hexagon screw C Line ST M10x50, 8.8	
1	039756R	Hexagon screw C Line ST M12x50, 8.8.	
2	003907R	Push-pin 1 3/4"z6-z20	
2	004125R	Safety screw 1 3/8" ; 32/38 z8	

EAN 13 BAR CODE

3831111020307	
3831111020314	
3831111020321	
3838433047562	
3831111008763	
3838433045872	

SPARE PARTS PTO DRIVE SHAFTS CLUTCH PARTS C Line TS

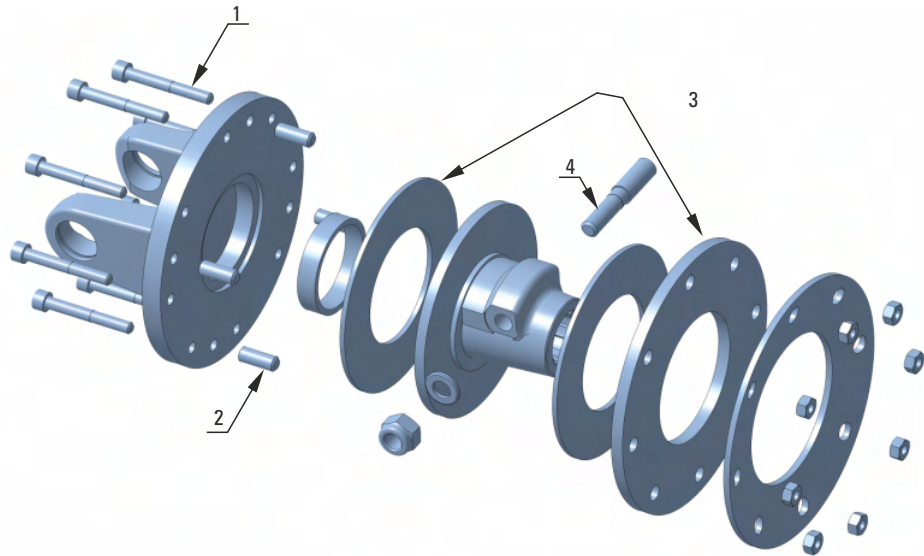

1 3/8"z6



1 3/8"z21



1 3/4"z6



1 3/8"z20

COMPONENTS

ARTICLE DESCRIPTION

ARTICLE	DESCRIPTION
007031R 1	Hexagon screw C Line TS M10x55
007033R 1	Hexagon screw C Line TS M10x75
007037R 2	Pressure relief screw C Line TS M10x25
007038R 2	Pressure relief screw C Line TS M10x40
004125R 2	Safety screw 1 3/8" ; 32/38 z8
007040R 3	Friction disk C Line TS, D141 d77
003907R 4	Push-pin 1 3/4"z6-z20

EAN 13 BAR CODE

EAN 13 BAR CODE	Barcode
3831111020345	
3831111020369	
3831111020406	
3831111020413	
3838433045872	
3831111020437	
3831111008763	



SPARE PARTS

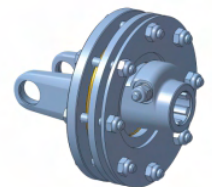
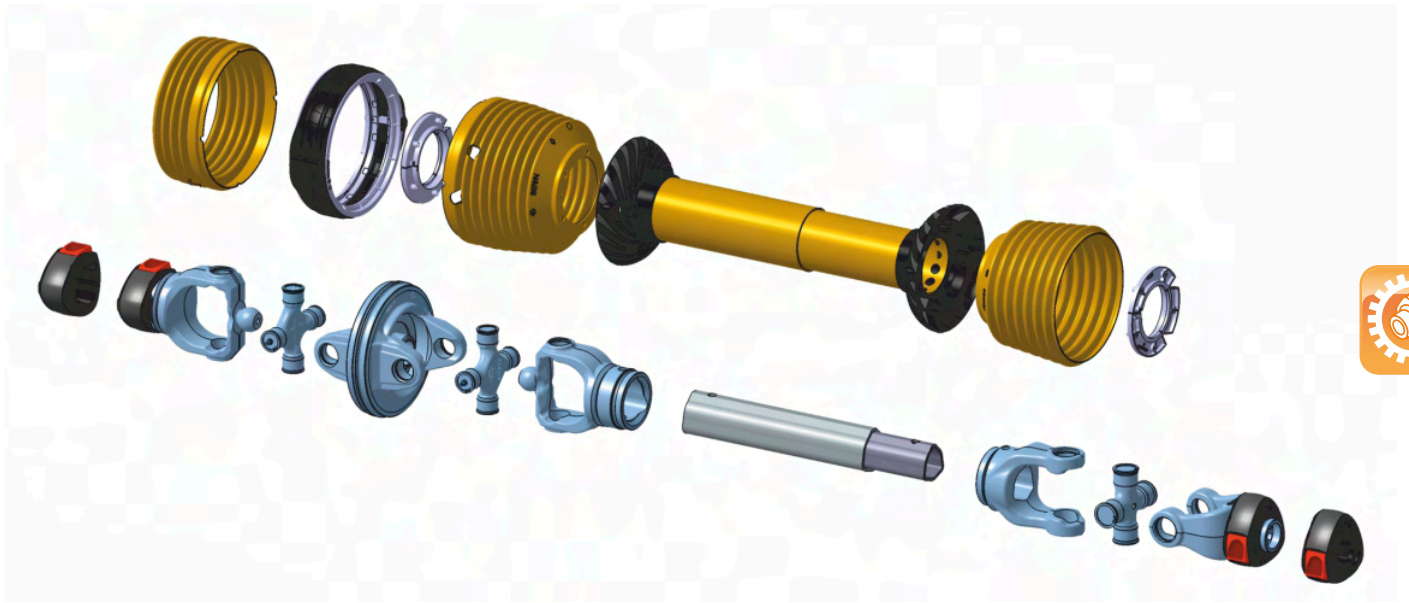

WIDE-ANGLE PTO DRIVE SHAFTS

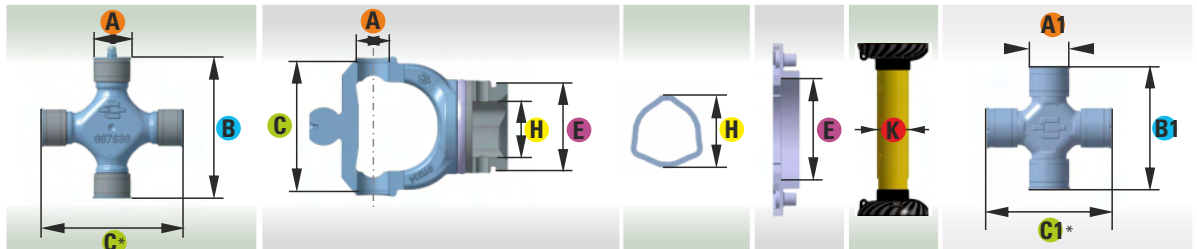

SPARE PARTS

WIDE-ANGLE PTO DRIVE SHAFTS



	A	B	C*	A	C	E	H	H	E	K	A1	B1	C1*
 30 kW / 40 HP	23,8	88	90,4*	23,8	90,4	61	43,5/36,5	43,5/36,5	61	67/61,5	27	74,6	77*
 52 kW / 70 HP	27	102	104,4*	27	104,4	76	53,5/45,5	53,5/45,5	76	82/76	30,2	91,4	94,4*
 85 kW / 115 HP	30,2	122	125*	30,2	125	83,8	62,6/53,6	62,6/53,6	83,8	92/86	34,9	106	109,45*

*measurement with spring clip

SPARE PARTS WIDE-ANGLE PTO DRIVE SHAFTS C Line 4 DZ

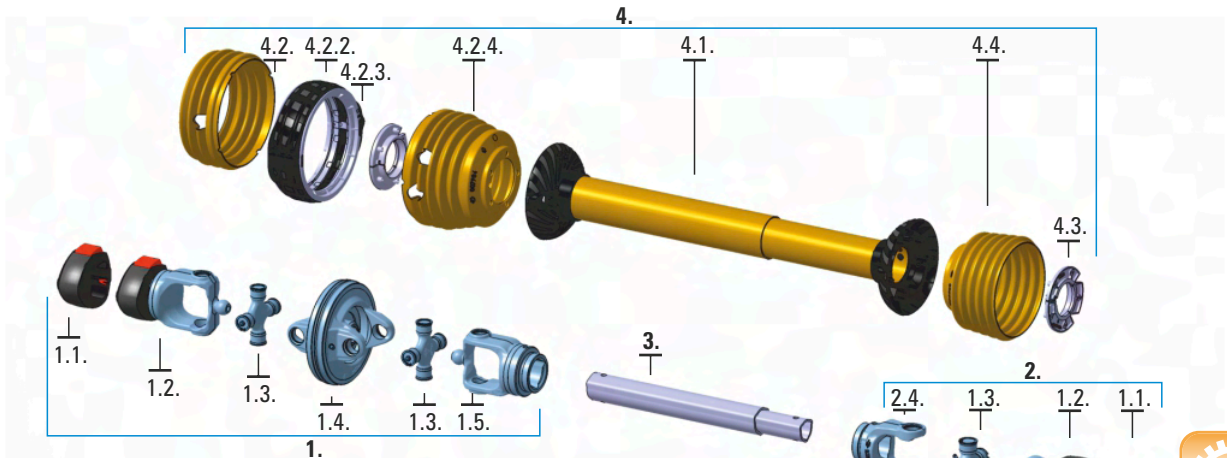

NR.	DESCRIPTION	Page in Catalogue
1.	Joint C Line 4 DZ BR TZ	141
1.1.	Cover C Line 4	112
1.2.	Outer yoke C Line 4 DZ	143
1.3.	Cross C Line 4 DZ	142
1.4.	Double yoke C Line 4 DZ	145
1.3.	Cross C Line 4 DZ	142
1.5.	Tube yoke C Line 4 DZ	144
2.	Joint C Line 4 BR TN	95
1.1.	Cover C Line 4	112
2.1.	Outer yoke C Line 4	99
2.2.	Cross C Line 4	98
2.3.	Tube yoke C Line 4 TN	100
2.B.	JJoint C Line 4 PS TN / C Line 4 PSL TN	95
2.2.2.	Clutch C Line 4 PS / C Line 4 PSL	101
2.2.	Cross C Line 4	98
2.3.	Tube yoke C Line 4 TN	100
2.C.	Joint C Line 4 VS1 TN	95
2.2.3.	Clutch C Line 4 VS1	103
2.2.	Cross C Line 4	98
2.3.	Tube yoke C Line 4 TN	100
2.D.	Joint C Line 4 ST TN	95
2.2.4.	Clutch C Line 4 ST	105
2.2.	Cross C Line 4	98
2.3.	Tube yoke C Line 4 TN	100
2.E.	Joint C Line 4 TS TN	95
2.2.5.	Clutch C Line 4 TS	106
2.2.	Cross C Line 4	98
2.3.	Tube yoke C Line 4 TN	100
3.	Metal tube C Line 4 DZ	146
4.	Safety Shield C Line 4 DZ kpl	149
4.1.	Safety Tube with Housing	155
4.2.	Cone 4 DZ	158
4.2.1.	Cone C Line 4 DZ	160
4.2.2.	Ring C Line 4 DZ	159
4.2.3.	Shield bearing PA C Line DZ 4	160
4.2.4.	Cone 4 DZ	159
4.3.	Shield bearing PA C Line 4	118
4.4.	Cone C Line 4 DZ	118
	Chain Type C Line	118

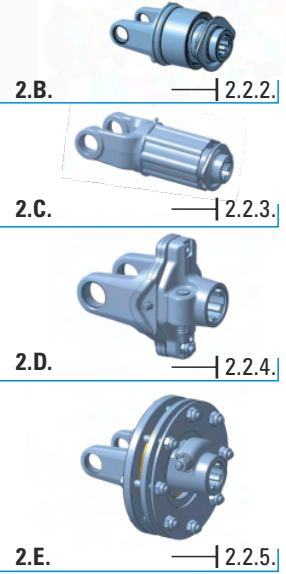

SPARE PARTS WIDE-ANGLE PTO DRIVE SHAFTS

C Line 4 DZ DZ

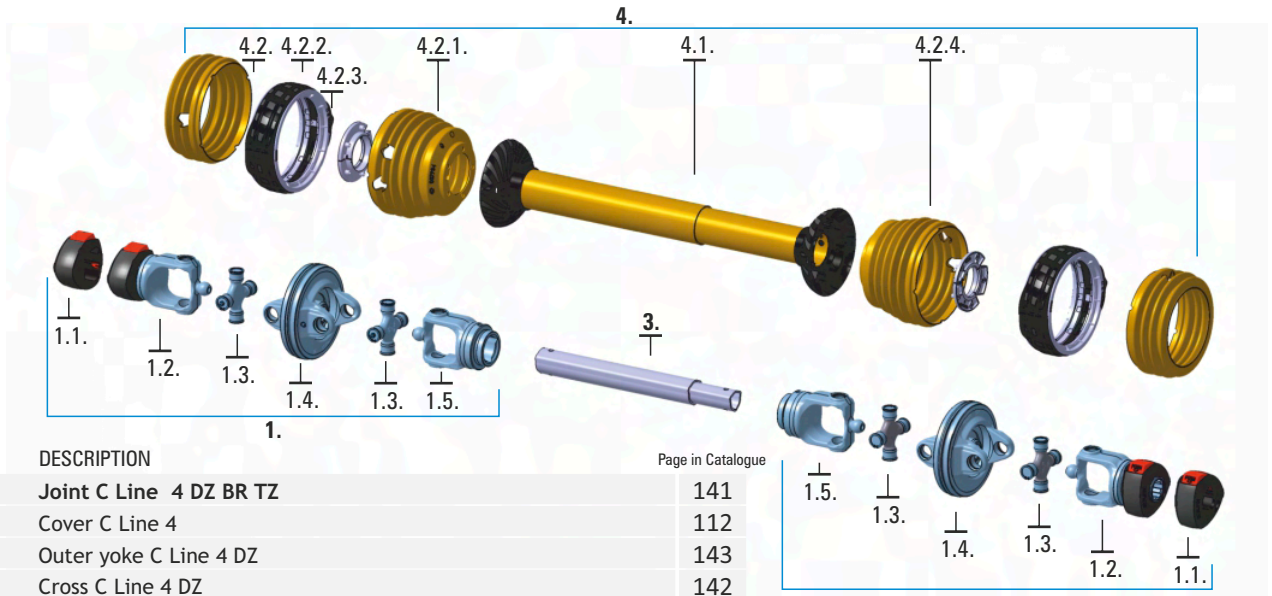

NR.	DESCRIPTION	Page in Catalogue
1.	Joint C Line 4 DZ BR TZ	141
1.1.	Cover C Line 4	112
1.2.	Outer yoke C Line 4 DZ	143
1.3.	Cross C Line 4 DZ	142
1.4.	Double yokes C Line 4 DZ	145
1.3.	Cross C Line 4 DZ	142
1.5.	Tube yoke C Line 4 DZ	144
2.	Joint C Line 4 DZ BR TN	141
1.1.	Cover C Line 4	112
1.2.	Outer yoke C Line 4 DZ	143
1.3.	Cross C Line 4 DZ	142
1.4.	Double yoke C Line 4 DZ	145
1.3.	Cross C Line 4 DZ	142
2.1.	Tube yoke C Line 4 DZ	144
3.	Metal tube C Line 4 DZ	146
4.	Safety Shield C Line 4 DZ DZ kpl	152
4.1.	Safety Tube with Housing	155
4.2.	Cone 4 DZ	158
4.2.1.	Cone C Line 4 DZ	159
4.2.2.	Ring C Line 4 DZ	160
4.2.3.	Shield bearing PA C Line DZ 4	160
4.2.4.	Protective Cone 4 DZ	159
	Chain Type C Line	118



SPARE PARTS WIDE-ANGLE PTO DRIVE SHAFTS C Line 6 DZ

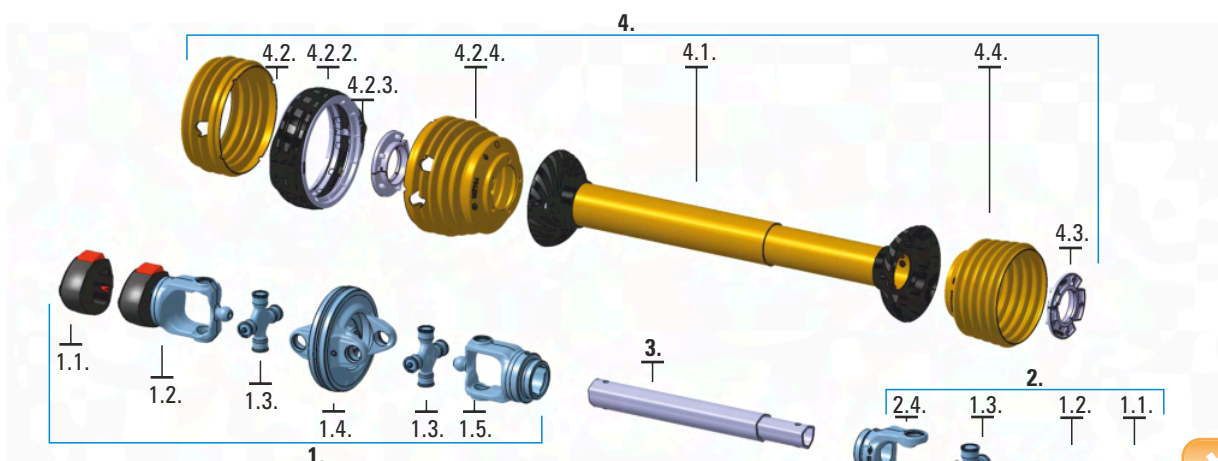

NR. DESCRIPTION Page in Catalogue

NR.	DESCRIPTION	Page in Catalogue
1.	Joint C Line 6 DZ BR TZ	141
1.1.	Cover C Line 6	112
1.2.	Outer yoke C Line 6 DZ	143
1.3.	Cross C Line 6 DZ	142
1.4.	Double yokes C Line 6 DZ	145
1.3.	Cross C Line 6 DZ	142
1.5.	Tube yoke C Line 6 DZ	144
2.	Joint C Line 6 BR TN	96
1.1.	Cover C Line 6	112
2.1.	Outer yoke C Line 6	99
2.2.	Cross C Line 6	98
2.3.	Tube yoke C Line 6 TN	100
2.B.	Joint C Line 6 PS TN / C Line 6 PSL TN	96
2.2.2.	Clutch C Line 6 PS / C Line 6 PSL	101
2.2.	Cross C Line 6	98
2.3.	Tube yoke C Line 6 TN	100
2.C.	Joint C Line 6 VS1 TN	96
2.2.3.	Clutch C Line 6 VS1	104
2.2.	Cross C Line 6	98
2.3.	Tube yoke C Line 6 TN	100
2.D.	Joint C Line 6 ST TN	96
2.2.4.	Clutch C Line 6 ST	105
2.2.	Cross C Line 6	98
2.3.	Tube yoke C Line 6 TN	100
2.E.	Joint C Line 6 TS TN	96
2.2.5.	Clutch C Line 6 TS	106
2.2.	Cross C Line 6	98
2.3.	Tube yoke C Line 6 TN	100
3.	Metal tube C Line 6 DZ	147
4.	Safety Shield C Line 6 DZ kpl	150
4.1.	Safety Tube with Housing	156
4.2.	Cone 6 DZ	158
4.2.1.	Cone C Line 6 DZ	159
4.2.2.	Ring C Line 6 DZ	160
4.2.3.	Shield bearing PA C Line DZ 6	160
4.2.4.	Cone 6 DZ	159
4.3.	Shield bearing PA C Line 6	118
4.4.	Cone C Line 6	118
	Chain Type C Line	118

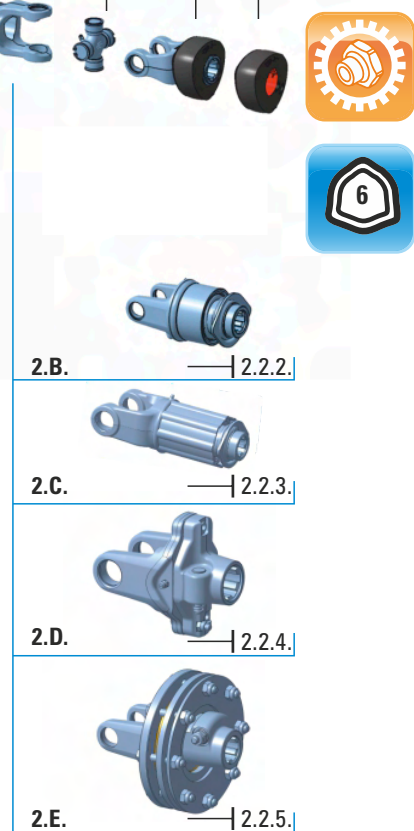

SPARE PARTS WIDE-ANGLE PTO DRIVE SHAFTS

C Line 6 DZ DZ

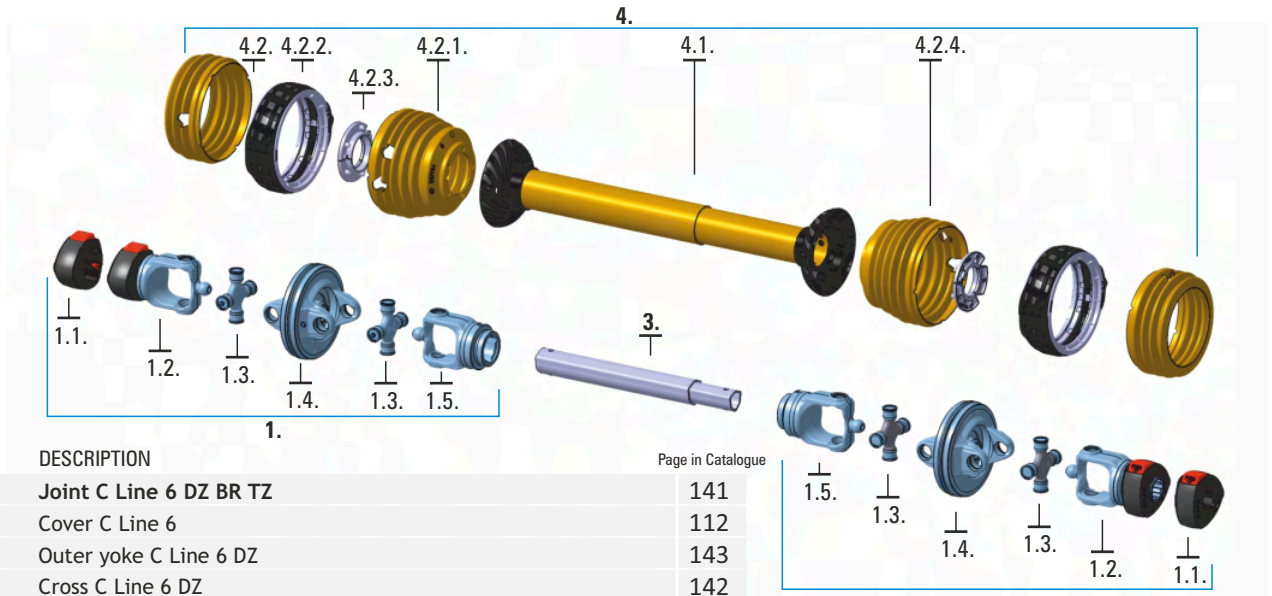

NR.	DESCRIPTION	Page in Catalogue
1.	Joint C Line 6 DZ BR TZ	141
1.1.	Cover C Line 6	112
1.2.	Outer yoke C Line 6 DZ	143
1.3.	Cross C Line 6 DZ	142
1.4.	Double yoke C Line 6 DZ	145
1.3.	Cross C Line 6 DZ	142
1.5.	Tube yoke C Line 6 DZ	144
2.	Joint C Line 6 DZ BR TN	141
1.1.	Cover C Line 6	112
1.2.	Outer yoke C Line 6 DZ	143
1.3.	Cross C Line 6 DZ	142
1.4.	Double yoke C Line 6 DZ	145
1.3.	Cross C Line 6 DZ	142
2.1.	Tube yoke C Line 6 DZ	144
3.	Metal tube C Line 6 DZ	147
4.	Safety Shield C Line 6 DZ DZ kpl	153
4.1.	Safety Tube with Housing	156
4.2.	Cone 6 DZ	158
4.2.1.	Cone C Line 6 DZ	159
4.2.2.	Ring C Line 6 DZ	160
4.2.3.	Shield bearing PA C Line DZ 6	160
4.2.4.	Cone 6 DZ	159
	Chain Type C Line	118



SPARE PARTS WIDE-ANGLE PTO DRIVE SHAFTS C Line 8 DZ

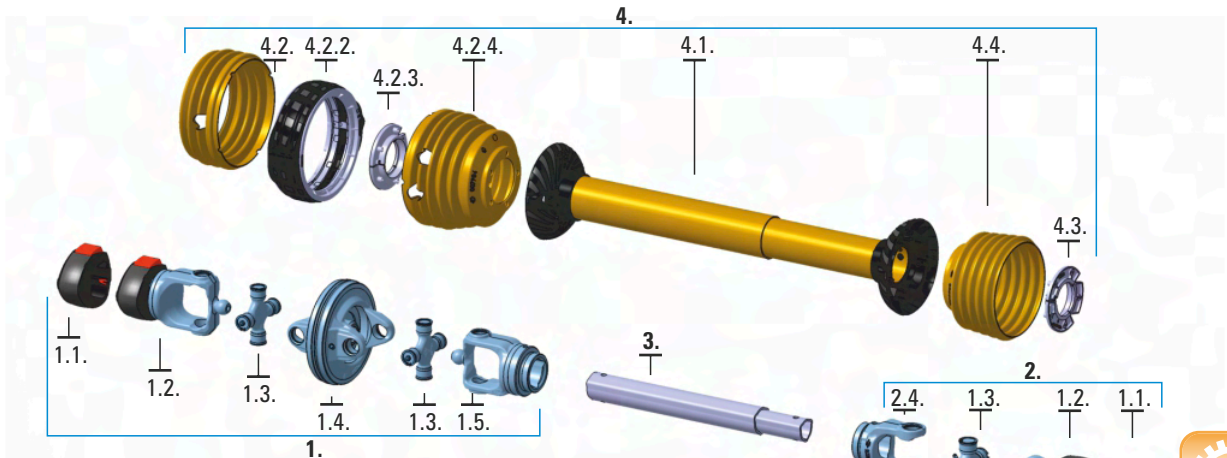

NR.	DESCRIPTION	Page in Catalogue
1.	Joint C Line 8 DZ BR TZ	141
1.1.	Cover C Line 8	112
1.2.	Outer yoke C Line 8 DZ	143
1.3.	Cross C Line 8 DZ	142
1.4.	Double yoke C Line 8 DZ	145
1.3.	Cross C Line 8 DZ	142
1.5.	Tube yoke C Line 8 DZ	144
2.	Joint C Line 8 BR TN	97
1.1.	Cover C Line 8	112
2.1.	Outer yoke C Line 8	99
2.2.	Cross C Line 8	98
2.3.	Tube yoke C Line 8 TN	100
2.B.	Joint C Line 8 PS TN / C Line 8 PSL TN	97
2.2.2.	Clutch C Line 8 PS / C Line 8 PSL	101
2.2.	Cross C Line 8	98
2.3.	Tube yoke C Line 8 TN	100
2.C.	Joint C Line 8 VS1 TN	97
2.2.3.	Clutch C Line 8 VS1	104
2.2.	Cross C Line 8	98
2.3.	Tube yoke C Line 8 TN	100
2.D.	Joint C Line 8 ST TN	97
2.2.4.	Clutch C Line 8 ST	105
2.2.	Cross C Line 8	98
2.3.	Tube yoke C Line 8 TN	100
2.E.	Joint C Line 8 TS TN	97
2.2.5.	Clutch C Line 8 TS	106
2.2.	Cross C Line 8	98
2.3.	Tube yoke C Line 8 TN	100
3.	Metal tube C Line 8 DZ	148
4.	Safety Shield C Line 8 DZ kpl	151
4.1.	Safety Tube with Housing	157
4.2.	Cone 8 DZ	158
4.2.1.	Cone C Line 8 DZ	159
4.2.2.	Ring C Line 8 DZ	160
4.2.3.	Shield bearing PA C Line DZ 8	160
4.2.4.	Cone 8 DZ	159
4.3.	Shield bearing PA C Line 8	118
4.4.	Cone C Line 8	118
	Chain Type C Line	118

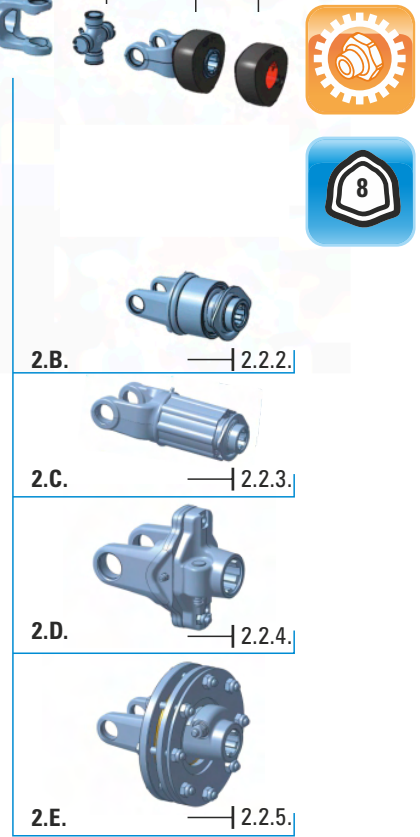

SPARE PARTS WIDE-ANGLE PTO DRIVE SHAFTS



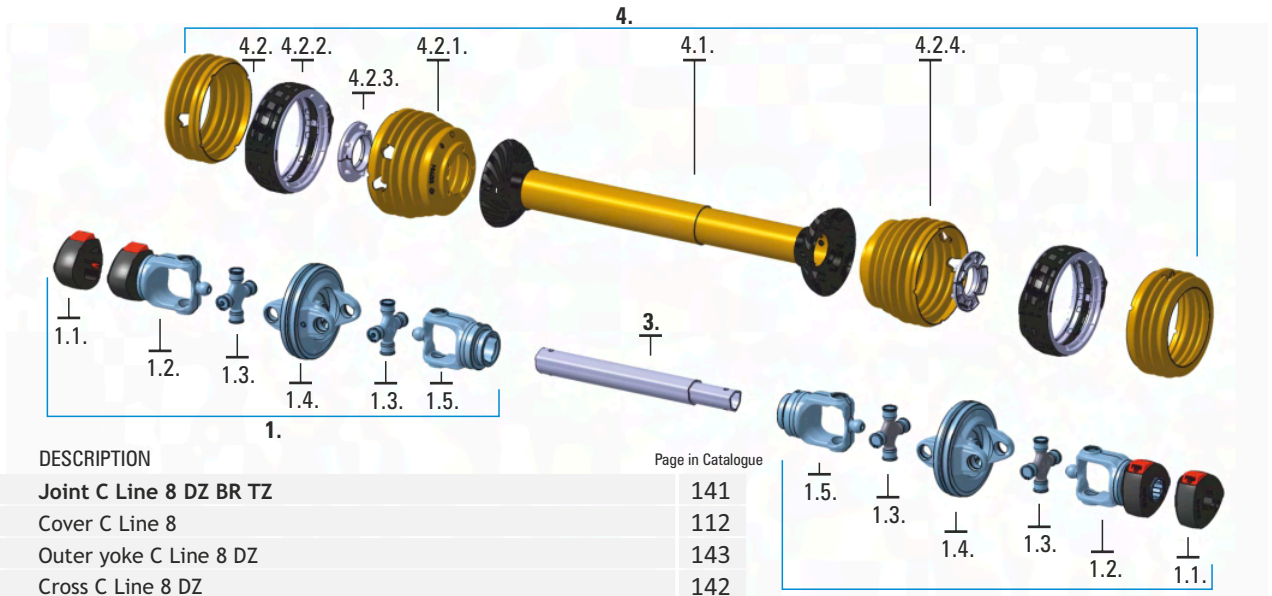





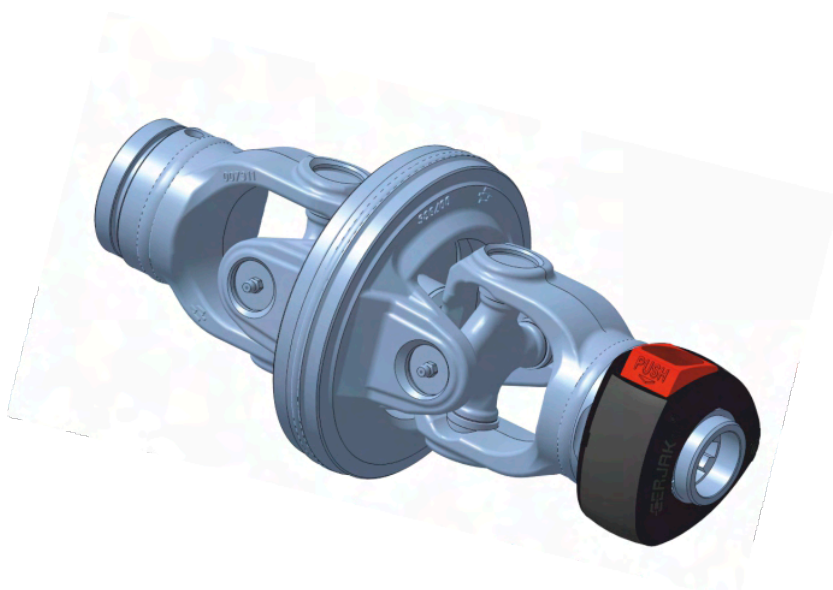

























C Line 8 DZ DZ



NR.	DESCRIPTION	Page in Catalogue
1.	Joint C Line 8 DZ BR TZ	141
1.1.	Cover C Line 8	112
1.2.	Outer yoke C Line 8 DZ	143
1.3.	Cross C Line 8 DZ	142
1.4.	Double yoke C Line 8 DZ	145
1.3.	Cross C Line 8 DZ	142
1.5.	Tube yoke C Line 8 DZ	144
2.	Joint C Line 8 DZ BR TN	141
1.1.	Cover C Line 8	112
1.2.	Outer yoke C Line 8 DZ	143
1.3.	Cross C Line 8 DZ	142
1.4.	Double yoke C Line 8 DZ	145
1.3.	Cross C Line 8 DZ	142
2.1.	Tube yoke C Line 8 DZ	144
3.	Metal tube C Line 8 DZ	148
4.	Safety Shield C Line 8 DZ DZ kpl	154
4.1.	Safety Tube with Housing	157
4.2.	Cone 8 DZ	158
4.2.1.	Cone C Line 8 DZ	159
4.2.2.	Ring C Line 8 DZ	160
4.2.3.	Shield bearing PA C Line DZ 8	160
4.2.4.	Cone 8 DZ	159
	Chain Type C Line	118

SPARE PARTS WIDE-ANGLE PTO DRIVE SHAFTS JOINT DZ



ARTICLE	DESCRIPTION		EAN 13 BAR CODE
021886R	C Line 4 DZ BR TN 1 3/8"z6	 1 3/8"z6	3838433005654 
009538R	C Line 4 DZ BR TZ 1 3/8"z6	 1 3/8"z6	3838433004473 
021815R	C Line 4 DZ BR TZ 1 3/8"z21	 1 3/8"z21	3838433005173 
021816R	C Line 4 DZ BR TZ 32/38 z8	 32/38 z8	3838433005180 
021892R	C Line 6 DZ BR TN 1 3/8"z6	 1 3/8"z6	3838433005715 
009539R	C Line 6 DZ BR TZ 1 3/8"z6	 1 3/8"z6	3838433004480 
021780R	C Line 6 DZ BR TZ 1 3/8"z21	 1 3/8"z21	3838433004831 
021781R	C Line 6 DZ BR TZ 32/38 z8	 32/38 z8	3838433004848 
021782R	C Line 6 DZ BR TZ 1 3/4"z6	 1 3/4"z6	3838433004855 
021783R	C Line 6 DZ BR TZ 1 3/4"z20	 1 3/4"z20	3838433004862 
007908R	C Line 8 DZ BR TN 1 3/8"z6	 1 3/8"z6	3838433005685 
021910R	C Line 8 DZ BR TN 1 3/4"z6	 1 3/4"z6	3838433005760 
007907R	C Line 8 DZ BR TZ 1 3/8"z6	 1 3/8"z6	3838433002424 
021772R	C Line 8 DZ BR TZ 1 3/8"z21	 1 3/8"z21	3838433004787 
021774R	C Line 8 DZ BR TZ 32/38 z8	 32/38 z8	3838433004794 
021775R	C Line 8 DZ BR TZ 1 3/4"z6	 1 3/4"z6	3838433004800 
021776R	C Line 8 DZ BR TZ 1 3/4"z20	 1 3/4"z20	3838433004817 

SPARE PARTS WIDE-ANGLE PTO DRIVE SHAFTS

CROSS C Line DZ / KPL



ARTICLE DESCRIPTION

EAN 13 BAR CODE

007981R	C Line 4 DZ 23,8x90,4	3838433004428	
007982R	C Line 6 DZ 27x104,4	3838433004435	
011328R	C Line 8 DZ 30,2x125	3838433002431	

SPARE PARTS WIDE-ANGLE PTO DRIVE SHAFTS OUTER YOKE C Line DZ

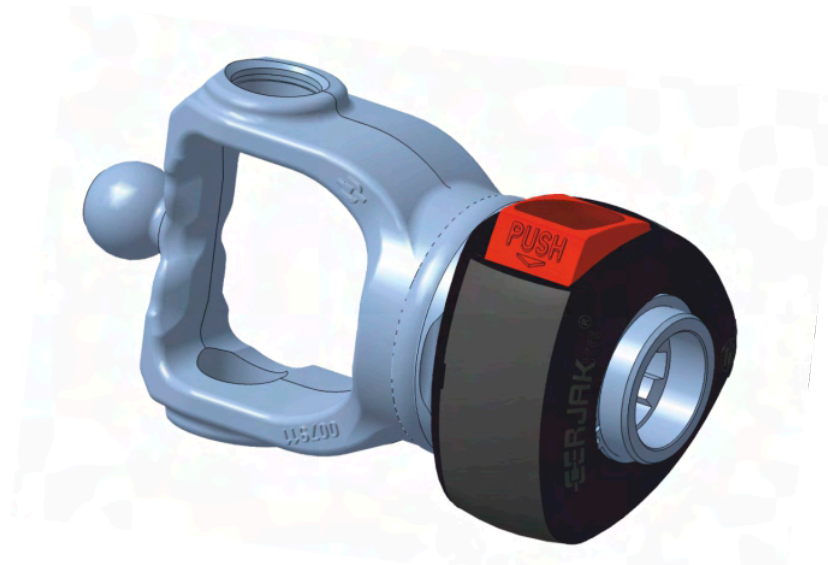







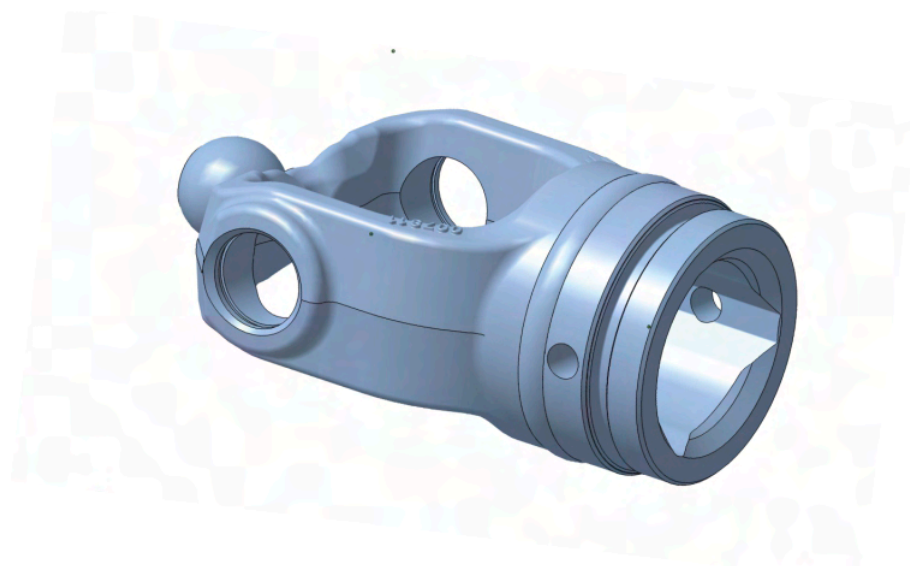

ARTICLE	DESCRIPTION		EAN 13 BAR CODE
018161R	C Line 4 DZ 1 3/8"z6	 1 3/8"z6	3838433004091 
021719R	C Line 4 DZ 1 3/8"z21	 1 3/8"z21	3838433004312 
021720R	C Line 4 DZ 32/38 z8	 32/38z8	3838433004329 
020590R	C Line 6 DZ 1 3/8"z6	 1 3/8"z6	3838433002585 
020641R	C Line 6 DZ 1 3/8"z21	 1 3/8"z21	3838433002820 
020642R	C Line 6 DZ 32/38 z8	 32/38z8	3838433002837 
020591R	C Line 6 DZ 1 3/4"z6	 1 3/4"z6	3838433002592 
020643R	C Line 6 DZ 1 3/4"z20	 1 3/4"z20	3838433002844 
007890R	C Line 8 DZ 1 3/8"z6	 1 3/8"z6	3838433002370 
020556R	C Line 8 DZ 1 3/8"z21	 1 3/8"z21	3838433002554 
020557R	C Line 8 DZ 32/38 z8	 32/38z8	3838433002561 
007892R	C Line 8 DZ 1 3/4"z6	 1 3/4"z6	3838433002387 
020554R	C Line 8 DZ 1 3/4"z20	 1 3/4"z20	3838433002547 

SPARE PARTS WIDE-ANGLE PTO DRIVE SHAFTS

TUBE YOKE C Line DZ



ARTICLE	DESCRIPTION		EAN 13 BAR CODE	
018165R	C Line 4 DZ TN		3838433004114	
018162R	C Line 4 DZ TZ		3838433004107	
020645R	C Line 6 DZ TN		3838433002868	
020644R	C Line 6 DZ TZ		3838433002851	
018158R	C Line 8 DZ TN		3838433002752	
007883R	C Line 8 DZ TZ		3838433002356	

SPARE PARTS WIDE-ANGLE PTO DRIVE SHAFTS
DOUBLE YOKE C Line DZ



ARTICLE	DESCRIPTION	EAN 13 BAR CODE
018166R	C Line 4 DZ	3838433004510 
009535R	C Line 6 DZ	3838433004466 
007884R	C Line 8 DZ	3838433002363 

SPARE PARTS WIDE-ANGLE PTO DRIVE SHAFTS

METAL TUBE C Line 4 DZ / KPL

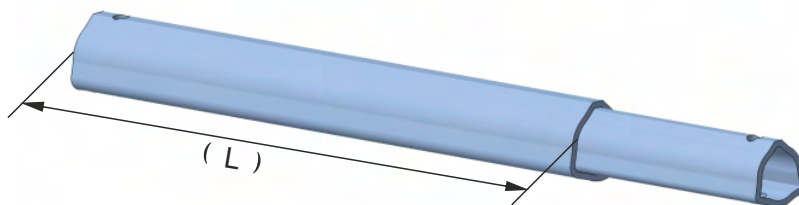

ARTICLE	DESCRIPTION	EAN 13 BAR CODE
021872R	4 kpl za kk710 (550)	3838433005548
021874R	4 kpl za kk810 (650)	3838433005562
021876R	4 kpl za kk910 (750)	3838433005586
021878R	4 kpl za kk1010 (850)	3838433005609
021880R	4 kpl za kk1210 (1050)	3838433005623
021882R	4 kpl za kk1410 (1250)	3838433005647

SPARE PARTS WIDE-ANGLE PTO DRIVE SHAFTS
METAL TUBE C Line 6 DZ / KPL

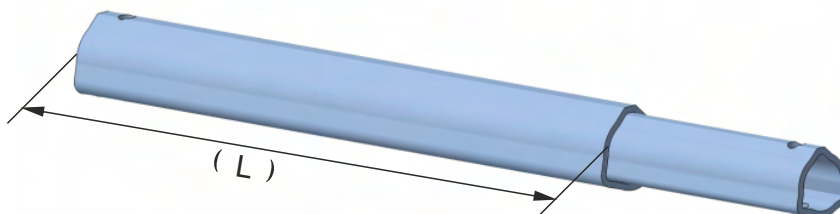

ARTICLE	DESCRIPTION	EAN 13 BAR CODE
006630R	6 kpl za kk710 (535)	3831111018502
006632R	6 kpl za kk810 (635)	3831111018526
006634R	6 kpl za kk910 (735)	3831111018540
006636R	6 kpl za kk1010 (830)	3831111018564
006638R	6 kpl za kk1210 (1030)	3831111018588
006640R	6 kpl za kk1410 (1230)	3831111018601

SPARE PARTS WIDE-ANGLE PTO DRIVE SHAFTS
METAL TUBE C Line 8 DZ / KPL

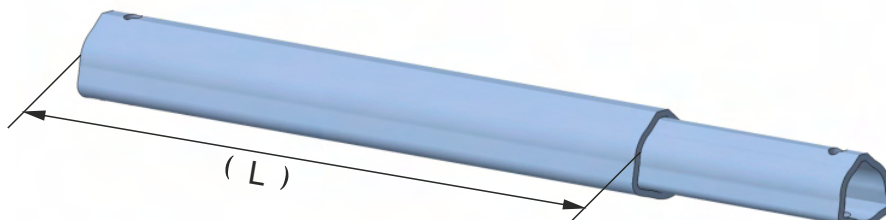

ARTICLE	DESCRIPTION	EAN 13 BAR CODE
009755R	8 kpl za kk710 (510)	3831111024480
009757R	8 kpl za kk810 (610)	3831111024503
009759R	8 kpl za kk910 (710)	3831111024527
009761R	8 kpl za kk1010 (810)	3831111024541
009763R	8 kpl za kk1210 (1010)	3831111024565
009766R	8 kpl za kk1410 (1210)	3831111024596

SPARE PARTS WIDE-ANGLE PTO DRIVE SHAFTS
SAFETY SHIELD C Line 4 DZ / KPL

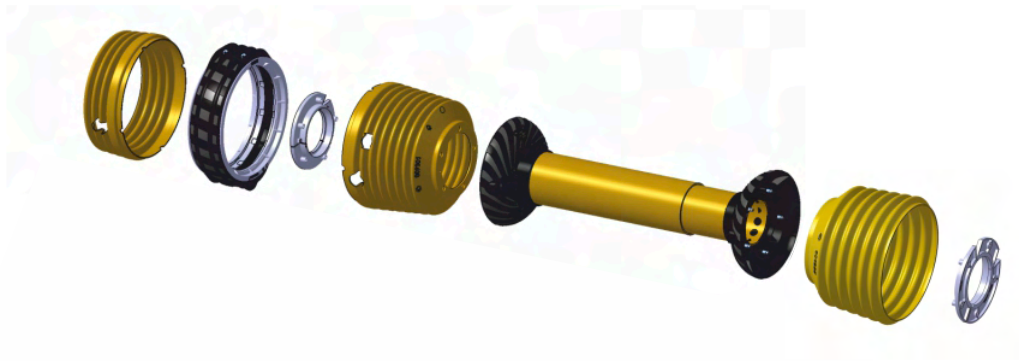

ARTICLE	DESCRIPTION	EAN 13 BAR CODE
021837R	C Line 4 DZ za kk710 (450)	3838433005388
021839R	C Line 4 DZ za kk810 (550)	3838433005401
021841R	C Line 4 DZ za kk910 (650)	3838433005425
021843R	C Line 4 DZ za kk1010 (750)	3838433005449
021845R	C Line 4 DZ za kk1210 (950)	3838433005463
021847R	C Line 4 DZ za kk1410 (1150)	3838433005487

SPARE PARTS WIDE-ANGLE PTO DRIVE SHAFTS

SAFETY SHIELD C Line 6 DZ / KPL

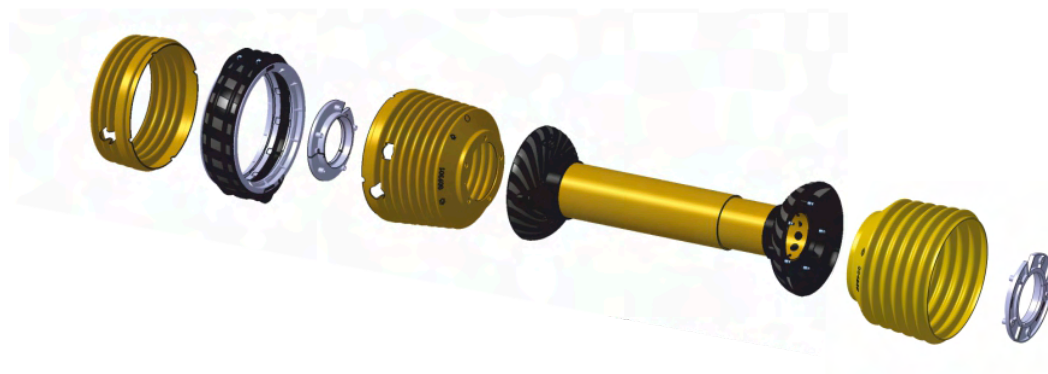

ARTICLE	DESCRIPTION	EAN 13 BAR CODE
021802R	C Line 6 DZ za kk710 (430)	3838433005043
021804R	C Line 6 DZ za kk810 (530)	3838433005067
021806R	C Line 6 DZ za kk910 (630)	3838433005081
021808R	C Line 6 DZ za kk1010 (730)	3838433005104
021810R	C Line 6 DZ za kk1210 (930)	3838433005128
021812R	C Line 6 DZ za kk1410 (1130)	3838433005142

SPARE PARTS WIDE-ANGLE PTO DRIVE SHAFTS
SAFETY SHIELD C Line 8 DZ / KPL

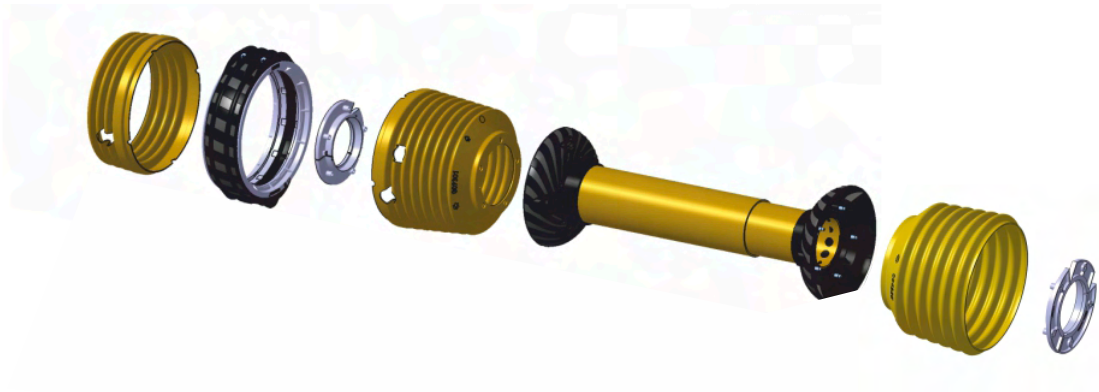

ARTICLE	DESCRIPTION	EAN 13 BAR CODE
021762R	C Line 8 DZ za kk710 (390)	3838433004688
020515R	C Line 8 DZ za kk810 (490)	3838433002523
021765R	C Line 8 DZ za kk910 (590)	3838433004718
021767R	C Line 8 DZ za kk1010 (690)	3838433004732
021769R	C Line 8 DZ za kk1210 (890)	3838433004756
021771R	C Line 8 DZ za kk1410 (1090)	3838433004770

SPARE PARTS WIDE-ANGLE PTO DRIVE SHAFTS

SAFETY SHIELD C Line 4 DZ DZ / KPL



ARTICLE	DESCRIPTION	EAN 13 BAR CODE
024042R	C Line 4 DZ DZ za kk710 (450)	3838433008563
023785R	C Line 4 DZ DZ za kk810 (550)	3838433008136
022559R	C Line 4 DZ DZ za kk910 (650)	3838433006491
022558R	C Line 4 DZ DZ za kk1010 (750)	3838433006484
021887R	C Line 4 DZ DZ za kk1210 (950)	3838433005661
022671R	C Line 4 DZ DZ za kk1410 (1150)	3838433006743

SPARE PARTS WIDE-ANGLE PTO DRIVE SHAFTS
SAFETY SHIELD C Line 6 DZ DZ / KPL

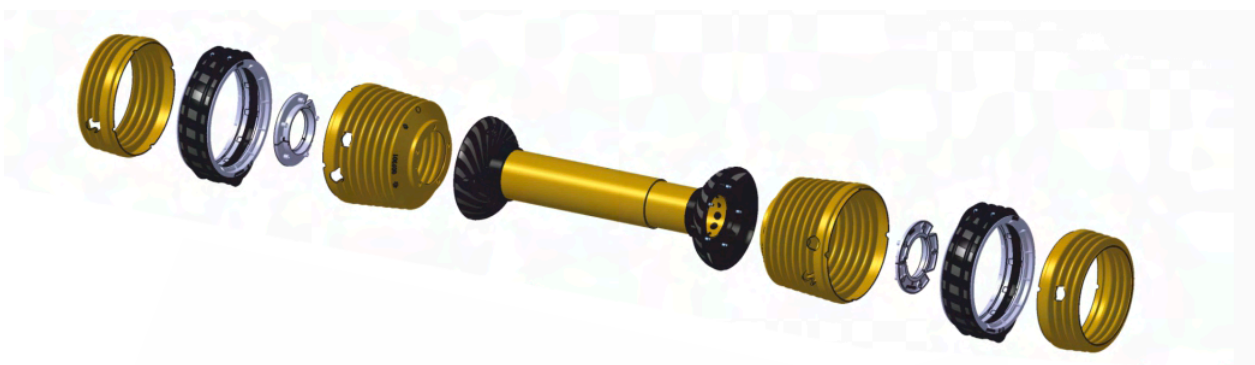

ARTICLE	DESCRIPTION	EAN 13 BAR CODE
024045R	C Line 6 DZ DZ za kk710 (430)	3838433008594
024044R	C Line 6 DZ DZ za kk810 (530)	3838433008587
024043R	C Line 6 DZ DZ za kk910 (630)	3838433008570
022053R	C Line 6 DZ DZ za kk1010 (730)	3838433006033
021890R	C Line 6 DZ DZ za kk1210 (930)	3838433005708
021893R	C Line 6 DZ DZ za kk1410 (1130)	3838433005722

SPARE PARTS WIDE-ANGLE PTO DRIVE SHAFTS

SAFETY SHIELD C Line 8 DZ DZ / KPL

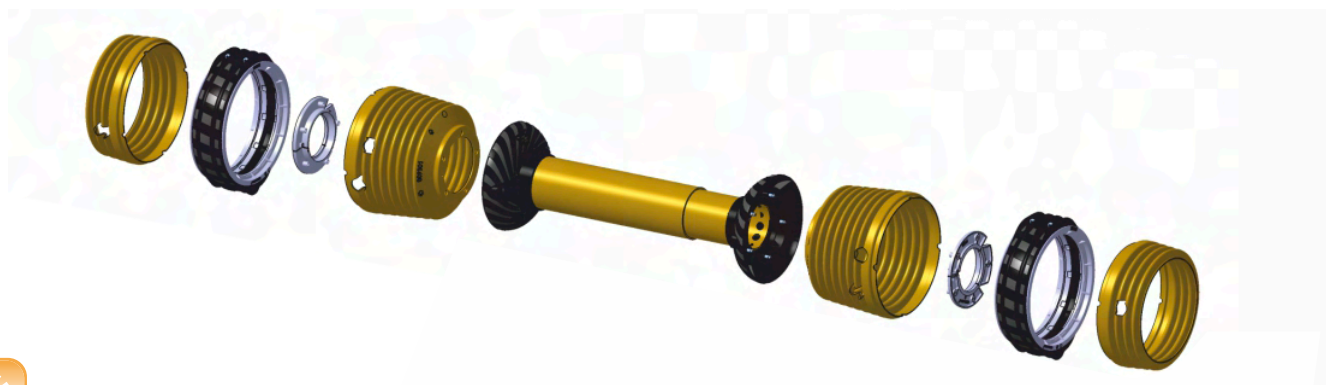

ARTICLE	DESCRIPTION	EAN 13 BAR CODE
024048R	C Line 8 DZ DZ za kk710 (390)	3838433008624 
024047R	C Line 8 DZ DZ za kk810 (490)	3838433008617 
024046R	C Line 8 DZ DZ za kk910 (590)	3838433008600 
022802R	C Line 8 DZ DZ za kk1010 (690)	3838433007030 
021901R	C Line 8 DZ DZ za kk1210 (890)	3838433005739 
021909R	C Line 8 DZ DZ za kk1410 (1090)	3838433005753 

SPARE PARTS WIDE-ANGLE PTO DRIVE SHAFTS
SAFETY TUBE WITH HOUSING C Line 4 DZ

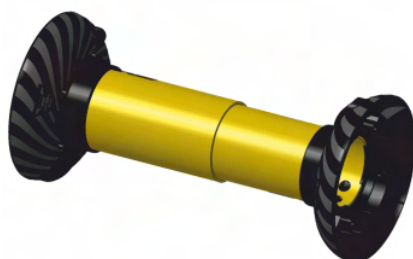

ARTICLE	DESCRIPTION	EAN 13 BAR CODE
021822R	C Line 4 DZ za kk710 (450)	3838433005234
021824R	C Line 4 DZ za kk810 (550)	3838433005258
021826R	C Line 4 DZ za kk910 (650)	3838433005272
021828R	C Line 4 DZ za kk1010 (750)	3838433005296
021830R	C Line 4 DZ za kk1210 (950)	3838433005319
021832R	C Line 4 DZ za kk1410 (1150)	3838433005333

SPARE PARTS WIDE-ANGLE PTO DRIVE SHAFTS

SAFETY TUBE WITH HOUSING C Line 6 DZ



ARTICLE	DESCRIPTION	EAN 13 BAR CODE
021787R	C Line 6 DZ za kk710 (430)	3838433004909
021789R	C Line 6 DZ za kk810 (530)	3838433004923
021791R	C Line 6 DZ za kk910 (630)	3838433004947
021793R	C Line 6 DZ za kk1010 (730)	3838433004961
021795R	C Line 6 DZ za kk1210 (930)	3838433004985
021797R	C Line 6 DZ za kk1410 (1130)	3838433005005

SPARE PARTS WIDE-ANGLE PTO DRIVE SHAFTS
SAFETY TUBE WITH HOUSING C Line 8 DZ



ARTICLE	DESCRIPTION	EAN 13 BAR CODE
021750R	C Line 8 DZ za kk710 (390)	3838433004565
021752R	C Line 8 DZ za kk810 (490)	3838433004589
021754R	C Line 8 DZ za kk910 (590)	3838433004602
021756R	C Line 8 DZ za kk1010 (690)	3838433004626
021758R	C Line 8 DZ za kk1210 (890)	3838433004640
021760R	C Line 8 DZ za kk1410 (1090)	3838433004664

SPARE PARTS WIDE-ANGLE PTO DRIVE SHAFTS

JOINT PROTECTION C Line DZ / KPL

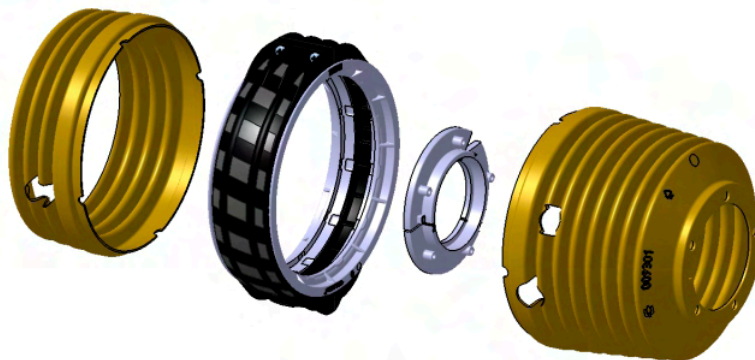

ARTICLE	DESCRIPTION	EAN 13 BAR CODE
022763R	C Line 4 DZ	3838433006637 
022764R	C Line 6 DZ	3838433006620 
022765R	C Line 8 DZ	3838433006613 

SPARE PARTS WIDE-ANGLE PTO DRIVE SHAFTS

PARTS OF PROTECTION C Line DZ

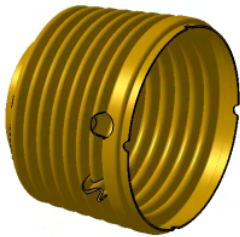

ARTICLE	DESCRIPTION	EAN 13 BAR CODE
020811R	C Line 4 DZ	3838433004534
020810R	C Line 6 DZ	3838433004527
007894R	C Line 8 DZ	3838433002394



ARTICLE	DESCRIPTION	EAN 13 BAR CODE
021854R	C Line 4 DZ	3838433005494
021813R	C Line 6 DZ	3838433005159
020516R	C Line 8 DZ	3838433002530

SPARE PARTS WIDE-ANGLE PTO DRIVE SHAFTS

PARTS OF PROTECTION C Line DZ



ARTICLE	DESCRIPTION	EAN 13 BAR CODE
009302R	4 DZ	3838433004442
009463R	6 DZ	3838433004459
007896R	8 DZ	3838433002417



ARTICLE	DESCRIPTION	EAN 13 BAR CODE
009540R	DZ 4	3838433004497
009541R	DZ 6	3838433004503
007895R	DZ 8	3838433002400

INQUIRY OF NON-STANDARD PTO DRIVE SHAFT

Customer information:

Name and surname: _____ Address: _____

Telephone: _____ E mail: _____

Payer information (if different from customer):

Name and surname: _____ Address: _____

Telephone: _____ E mail: _____

Delivery information (if different from customer):

Name and surname: _____ Address: _____

Telephone: _____ E mail: _____

Information about mover (tractor)

MANUFACTURER / MODEL / TYPE: _____

NOMINAL POWER kW/HP: _____ kW _____ HP NO. of ROTATIONS (min): 540/540e/750 1000 other: _____

Information about working machine (connected machine):

MANUFACTURER / MODEL / TYPE: _____

Working number of rotations (rpm) _____ Maximum torque (Nm) _____

Information about coupling profile:

- A**
- 1 3/8" Z6
 - 1 3/8" Z21
 - 1 3/4" Z6
 - 1 3/4" Z20
 - 32x38 Z8
 - OTHER _____

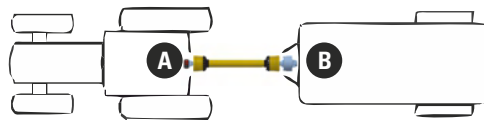

- B**
- 1 3/8" Z6
 - 1 3/8" Z21
 - 1 3/4" Z6
 - 1 3/4" Z20
 - 32x38 Z8
 - OTHER _____

Information about the length of PTO drive shaft:

- Towed connected machine with pivot point between shafts

Lmin _____ mm

Lmax _____ mm

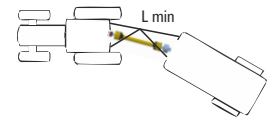
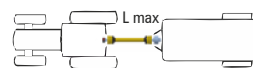
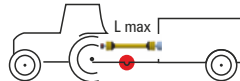

- Towed connected machine with pivot point in front of the shaft on the tractor

Lmin _____ mm

Lmax _____ mm

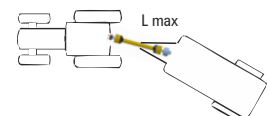
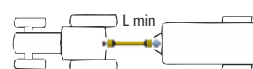
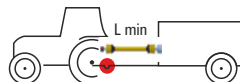

- Carried connected machine

Lmin _____ mm

Lmax _____ mm

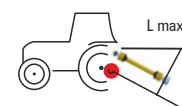
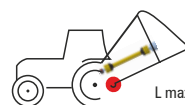
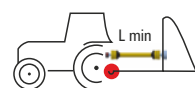





CERJAK

Cerjak d.o.o.,
Žadovinek 38,
SI-8273 Leskovec pri Krškem,
Slovenia
Tel.: +386 (0)7 49 21 682
Fax: +386 (0)7 49 21 683
E-mail: info@cerjak.si
Internet: www.cerjak.si



C Line

Ver. 2