



## KARDANSKE GREDI

KARDANSKA VRATILA | KARDÁN TENGELY | KARDANOVÉ HŘÍDELE

S Q L



Katalog ali dele kataloga ni dovoljeno razmnoževati ali kopirati brez predhodnega dovoljenja podjetja Cerjak d.o.o.. Vsi podatki tega kataloga nadomestijo podatke iz predhodnih publikacij. Posledično bi lahko bili podatki iz predhodnih publikacij neveljavni.

Katalog smo pripravili z veliko pozornosti in natančnosti, vendar ne nosimo odgovornosti za tipografske napake in nepopolne podatke. Pridružujemo si pravico do spremembe specifikacij in tehničnih podatkov brez predhodnega opozorila.



Katalog ili dio kataloga nije dozvoljeno umnožavati ili kopirati bez prethodne suglasnosti poduzeća Cerjak doo.. Svi podaci toga kataloga zamenjuju podatke iz prethodnih publikacija. Posledično bi mogli biti podaci iz prethodnih publikacija nevažeci.

Katalog smo pripravili s mnogo pažnje i preciznosti, ali ne želimo snositi odgovornost za štamparske greške i nepotpune informacije. Pridržavamo si pravo promene specifikacija i tehničkih podataka bez prethodnog obaveštenja.



A katalógus, illetve a katalógus részeinek sokszorosítása és másolása a Cerjak d.o.o. vállalat előzetes engedélye nélkül tilos. A katalógus minden adata felülírja a régebbi kiadványokban szereplő adatokat, ennek következtében a régebbi kiadványok egyes adatai érvénytelenek lehetnek.

A katalógust nagy odafigyeléssel, pontosan készítettük el, ugyanakkor nem vállalunk felelősséget a tipográfiai hibákért és a hiányos adatokért. Fenntartjuk a termékleírás és a műszaki adatok előzetes tájékoztatás nélküli megváltoztatásának jogát.



Katalog nebo jeho části není dovoleno rozmnožovat nebo kopírovat bez předchozího povolení společnosti Cerjak d.o.o. Všechny údaje v tomto katalogu nahrazují údaje z předchozích publikací. Z toho plyne, že údaje v předchozích publikacích mohou být neplatné.

Katalog jsme připravili velice pečlivě a s velkou přesností, přesto neneseme odpovědnost za typografické chyby a neúplné údaje. Vyhrazujeme si právo na změnu specifikací a technických údajů bez předchozího upozornění.



**VELIKOST**

VELIČINA |  
NAGYSÁG | VELIKOST

**KARDANSKI KRIŽ**

KARDANSKI KRIŽ |  
KARDÁN KERESZT | KARDANOVÝ KŘÍŽ

**ZUNANJA CEV**

VANJSKA CIJEV |  
KÜLSŐ CSŐ | VNĚJŠÍ TRUBKA

**NOTRANJA CEV**

UNUTRAŠNJA CIJEV |  
BELSŐ CSŐ | VNITŘNÍ TRUBKA

**1**

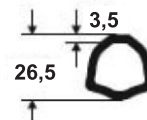
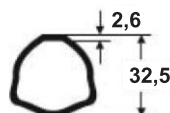
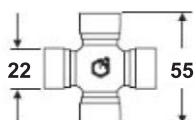

**4**

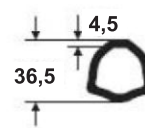
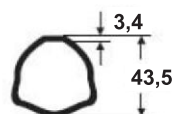
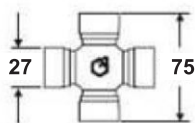

**6**

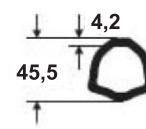
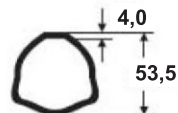
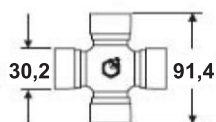

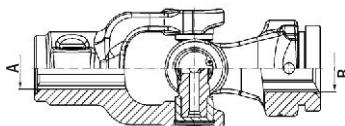

**KARDANSKI ZGLOB**  
KARDANSKI ZGLOB  
KARDÁN CSUKLÓ  
KARDANOVÝ KLOUB

ARTIKEL ARTIKAL   CIKK   ARTIKL	OZNAKA OZNAKA   MEGJELŐLÉS   OZNAČENÍ	PROFIL A PROFIL A   FORMA A   PROFIL A	PROFIL B PROFIL B   FORMA B   PROFIL B	EAN 13 ČRTNA KODA EAN 13-KODNA CRTA   EAN 13-KÓD SZÁM   ČÁROVÝ KÓD EAN 13	
002895R	S1 BR TZ 1 3/8"z6	1 3/8"z6	32,5	3831111002396	
002896R	S1 BR TN 1 3/8"z6	1 3/8"z6	26,5	3831111002402	
002897R	S4 BR TZ 1 3/8"z6	1 3/8"z6	43,5	3831111002419	
002898R	S4 BR TN 1 3/8"z6	1 3/8"z6	36,5	3831111002426	
002899R	S6 BR TZ 1 3/8"z6	1 3/8"z6	53,5	3831111002433	
002900R	S6 BR TN 1 3/8"z6	1 3/8"z6	45,5	3831111002440	
002901R	S4 PS TN 1 3/8"z6	1 3/8"z6	36,5	3831111002457	
002902R	S4 VS 600Nm TN 1 3/8"z6	1 3/8"z6	36,5	3831111002464	
002903R	S4 VS 900Nm TN 1 3/8"z6	1 3/8"z6	36,5	3831111002471	
002904R	S4 ST 900Nm TN 1 3/8"z6	1 3/8"z6	36,5	3831111002488	
002905R	S4 TS 800Nm TN 1 3/8"z6	1 3/8"z6	36,5	3831111002495	
002907R	S6 PS TN 1 3/8"z6	1 3/8"z6	45,5	3831111002518	
002908R	S6 ST 2700Nm TN 1 3/8"z6	1 3/8"z6	45,5	3831111002525	
002909R	S6 TS 1200Nm TN 1 3/8"z6	1 3/8"z6	45,5	3831111002532	

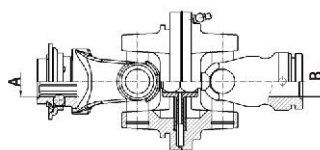

**KARDANSKI ZGLOB DZ**  
KARDANSKI ZGLOB DZ  
KARDÁN CSUKLÓ DZ  
KARDANOVÝ KLOUB DZ

ARTIKEL ARTIKAL   CIKK   ARTIKL	OZNAKA OZNAKA   MEGJELŐLÉS   OZNAČENÍ	PROFIL A PROFIL A   FORMA A   PROFIL A	PROFIL B PROFIL B   FORMA B   PROFIL B	EAN 13 ČRTNA KODA EAN 13-KODNA CRTA   EAN 13-KÓD SZÁM   ČÁROVÝ KÓD EAN 13	
002906R	S4 DZ BR TZ 1 3/8"z6	1 3/8"z6	43,5	3831111002501	



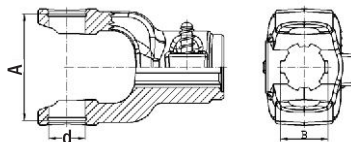

**VILICA PRIKLUČNA**  
PRIKLUČNA VILICA  
KAPCSOLÓ VILLÁK  
PŘIPOJOVACÍ VIDLICE

ARTIKEL ARTIKAL   CIKK   ARTIKL	OZNAKA OZNAKA   MEGJELŐLÉS   OZNAČENÍ	PROFIL B PROFIL B   FORMA B   PROFIL B	d	A	EAN 13 ČRTNA KODA EAN 13-KODNA CRTA   EAN 13-KÓD SZÁM   ČÁROVÝ KÓD EAN 13	
002930R	S1	1 3/8"z6	22	57	3831111002549	
002931R	S4	1 3/8"z6	27	77,4	3831111002556	
002932R	S6	1 3/8"z6	30,2	94,4	3831111002563	

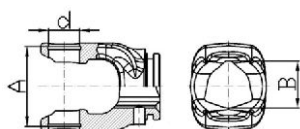

**VILICA CEVNA**  
CIJEVNA VILICA  
CSŐ VILLÁK  
VIDLICE TRUBKOVÁ

ARTIKEL ARTIKAL   CIKK   ARTIKL	OZNAKA OZNAKA   MEGJELŐLÉS   OZNAČENÍ	PROFIL B PROFIL B   FORMA B   PROFIL B	d	A	EAN 13 ČRTNA KODA EAN 13-KODNA CRTA   EAN 13-KÓD SZÁM   ČÁROVÝ KÓD EAN 13	
002933R	S1 TZ	32,5	22	57	3831111002570	
002934R	S1 TN	26,5	22	57	3831111002587	
002935R	S4 TZ	43,5	27	77,4	3831111002594	
002936R	S4 TN	36,5	27	77,4	3831111002600	
002937R	S6 TZ	53,5	30,2	94,4	3831111002617	
002938R	S6 TN	45,5	30,2	94,4	3831111002624	

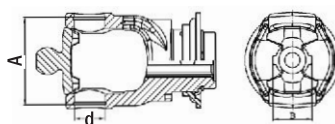

**VILICA PRIKLUČNA DZ SNM**  
PRIKLUČNA VILICA DZ SNM  
KAPCSOLÓ VILLÁK DZ SNM  
PŘIPOJOVACÍ VIDLICE DZ SNM

ARTIKEL ARTIKAL   CIKK   ARTIKL	OZNAKA OZNAKA   MEGJELŐLÉS   OZNAČENÍ	PROFIL B PROFIL B   FORMA B   PROFIL B	d	A	EAN 13 ČRTNA KODA EAN 13-KODNA CRTA   EAN 13-KÓD SZÁM   ČÁROVÝ KÓD EAN 13	
002962R	S4 DZ SNM 1 3/8"z6	1 3/8"z6	27	77,4	3831111002778	
002963R	S4 DZ SNM 1 3/8"z21	1 3/8"z21	27	77,4	3831111002785	
011258R	S4 DZ SNM 32/38z8	32/38z8	27	77,4	3831111099204	

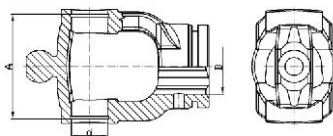

**VILICA CEVNA DZ**  
 CIJEVNA VILICA DZ  
 CSŐ VILLÁK DZ  
 TRUBKOVÁ VIDLICE DZ

ARTIKEL ARTIKAL   CIKK   ARTIKL	OZNAKA OZNAKA   MEGJELŐLÉS   OZNAČENÍ	PROFIL B PROFIL B   FORMA B   PROFIL B	d	A	EAN 13-ČRTNA KODA EAN 13-KODNA CRTA   EAN 13-KÓD SZÁM   ČÁROVÝ KÓD EAN 13	
002968R	S4 DZ TZ	43,5	27	77,4	3831111002792	
002969R	S4 DZ TN	36,5	27	77,4	3831111002808	

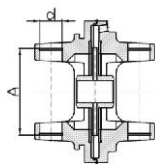

**OHIŠJE - SREDNJI DEL DZ**  
 KUČIŠTE - SREDNJI DIO DZ  
 KÖZÉPRÉS SZÉLESSZÖGŰ CSUKLÓHOZ  
 STŘEDNÍ DÍL DZ

ARTIKEL ARTIKAL   CIKK   ARTIKL	OZNAKA OZNAKA   MEGJELŐLÉS   OZNAČENÍ	d	A	EAN 13-ČRTNA KODA EAN 13-KODNA CRTA   EAN 13-KÓD SZÁM   ČÁROVÝ KÓD EAN 13	
002793R	S4 DZ	23,8	93,5	3831111002211	



**VARNOSTNI ZATIČI 10 KOS**  
 SIGURNOSTNI VIJAK 10 KOM  
 BIZTONSÁGI CSAPSZEG 10 DB  
 ZAJIŠŤOVACÍ KOLÍK 10 KS

ARTIKEL ARTIKAL   CIKK   ARTIKL	OZNAKA OZNAKA   MEGJELŐLÉS   OZNAČENÍ	EAN 13-ČRTNA KODA EAN 13-KODNA CRTA   EAN 13-KÓD SZÁM   ČÁROVÝ KÓD EAN 13	
002678R	Varnostni zatič C   Sigurnostni vijak C   Biztonsági csapszeg C   Zajišťovací kolík C	3831111001160	
002677R	Varnostni zatič B   Sigurnostni vijak B   Biztonsági csapszeg B   Zajišťovací kolík B	3831111001153	

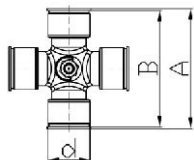

KRIŽ  
KRIŽ  
KERESZTEK  
KŘÍŽ

ARTIKEL ARTIKAL   CIKK   ARTIKL	OZNAKA OZNAKA   MEGJELŐLÉS   OZNAČENÍ	PROFIL (d×B) PROFIL (d×B)   FORMA (d×B)   PROFIL (d×B)	A	EAN 13 ČRTNA KODA EAN 13-KODNA CRTA   EAN 13-KÓD SZÁM   ČÁROVÝ KÓD EAN 13	
002980R	S1 22x55	22x55	57	3831111002839	
002984R	S4 27x75	27x75	77,4	3831111002860	
002987R	S6 30,2x91,4	30,2x91,4	94,4	3831111002891	

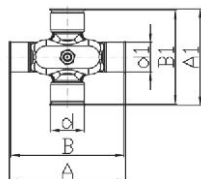

KRIŽ DZ  
KRIŽ DZ  
KERESZTEK DZ  
KŘÍŽ DZ

ARTIKEL ARTIKAL   CIKK   ARTIKL	OZNAKA OZNAKA   MEGJELŐLÉS   OZNAČENÍ	dxA1/d1xA	EAN 13 ČRTNA KODA EAN 13-KODNA CRTA   EAN 13-KÓD SZÁM   ČÁROVÝ KÓD EAN 13	
002986R	S4 DZ 27x75/23,8x91,2	27x77,4/23,8x93,5	3831111002884	

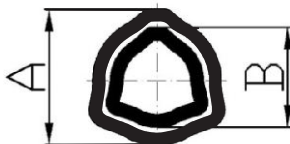

**KOVINSKE CEVI / KOMPLET**  
 ČELIČNE CIJEVI / KOMPLET  
 FÉMCSÖVEK / KOMPLET  
 KOVOVÁ TRUBKA / KPL

ARTIKEL ARTIKAL   CIKK   ARTIKL	OZNAKA OZNAKA   MEGJELÖLÉS   OZNAČENÍ	DOLŽINA DUŽINA   HOSSZÚSÁG   DÉLKA	PROFIL (A/B)	EAN 13 ČRTNA KODA EAN 13-KODNA CRTA   EAN 13-KÓD SZÁM   ČÁROVÝ KÓD EAN 13	
002501R	1 T kpl L500	L500	32,5/26,5	3831111000231	
002502R	1 T kpl L750	L750	32,5/26,5	3831111000248	
002506R	1 T kpl L1000	L1000	32,5/26,5	3831111000279	
003969R	1 T kpl L1500	L1500	32,5/26,5	3831111007179	
003972R	1 T kpl L2000	L2000	32,5/26,5	3831111007193	
002507R	1 T kpl L3000	L3000	32,5/26,5	3831111000286	
002509R	4 T kpl L500	L500	43,5/36,5	3831111000309	
002512R	4 T kpl L750	L750	43,5/36,5	3831111000330	
002514R	4 T kpl L1000	L1000	43,5/36,5	3831111000354	
003479R	4 T kpl L1500	L1500	43,5/36,5	3831111006783	
003480R	4 T kpl L2000	L2000	43,5/36,5	3831111006790	
002515R	4 T kpl L3000	L3000	43,5/36,5	3831111000361	
002516R	6 T kpl L500	L500	53,5/45,5	3831111000378	
002518R	6 T kpl L750	L750	53,5/45,5	3831111000392	
002520R	6 T kpl L1000	L1000	53,5/45,5	3831111000415	
003251R	6 T kpl L1500	L1500	53,5/45,5	3831111004819	
003975R	6 T kpl L2000	L2000	53,5/45,5	3831111007223	
002521R	6 T kpl L3000	L3000	53,5/45,5	3831111000422	

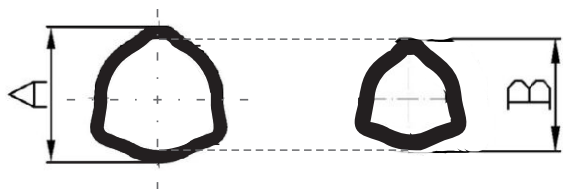

KOVINSKA CEV Z/N  
 ČELIČNA CIJEV Z/N  
 FÉMCSÖVEK Z/N  
 KOVOVÁ TRUBKA Z/N

ARTIKEL ARTIKAL   CIKK   ARTIKL	OZNAKA OZNAKA   MEGJELÖLÉS   OZNAČENÍ	DOLŽINA DUŽINA   HOSSZÚSÁG   DÉLKA	PROFIL (A/B)	EAN 13 KÓD SZÁM   ČÁROVÝ KÓD EAN 13	EAN 13 ČRTNA KODA EAN 13-KODNA CRTA
002528R	1 TZ L3000	L3000	32,5	3831111000491	
002548R	1 TN L3000	L3000	26,5	3831111000699	
002535R	4 TZ L3000	L3000	43,5	3831111000569	
002555R	4 TN L3000	L3000	36,5	3831111000767	
002541R	6 TZ L3000	L3000	53,5	3831111000620	
002561R	6 TN L3000	L3000	45,5	3831111000828	

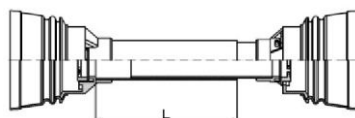

**ZAŠČITA**  
ZAŠTITA  
VÉDŐBURKOLAT  
PLASTOVÝ KRYT

ARTIKEL ARTIKAL   CIKK   ARTIKL	OZNAKA OZNAKA   MEGJELŐLÉS   OZNAČENÍ	DOLŽINA DUŽINA   HOSSZÚSÁG   DÉLKA	d/D	EAN 13 ČRTNA KODA EAN 13-KODNA CRTA   EAN 13-KÓD SZÁM   ČÁROVÝ KÓD EAN 13	
002686R	S1 kpl L400	L400	50/55	3831111001238	
003929R	S1 kpl L660	L660	50/55	3831111022448	
004251R	S1 kpl L1000	L1000	50/55	3831111007759	
002688R	S4 kpl L400	L400	65/70	3831111001252	
002690R	S4 kpl L650	L650	65/70	3831111001276	
002684R	S4 kpl L1000	L1000	65/70	3831111001221	
002692R	S6 kpl L400	L400	76/81	3831111001290	
004157R	S6 kpl L650	L650	76/81	3831111022066	
004070R	S6 kpl L1060	L1060	76/81	3831111014542	

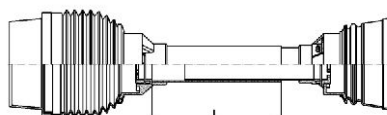

**ZAŠČITA KOMPLET DZ**  
ZAŠTITA KOMPLET DZ  
VÉDŐBURKOLAT KPL DZ  
PLASTOVÝ KRYT DZ

ARTIKEL ARTIKAL   CIKK   ARTIKL	OZNAKA OZNAKA   MEGJELŐLÉS   OZNAČENÍ	DOLŽINA DUŽINA   HOSSZÚSÁG   DÉLKA	EAN 13 ČRTNA KODA EAN 13-KODNA CRTA   EAN 13-KÓD SZÁM   ČÁROVÝ KÓD EAN 13	
004252R	S4 DZ kpl L650	L650	3831111007766	
007242R	S4 DZ kpl L980	L980	3831111099433	

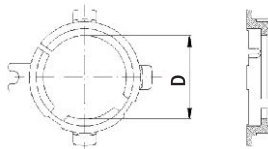

**LEŽAJ PE**  
LEŽAJ PE  
CSAPÁGY PE  
LOŽISKA PE

ARTIKEL ARTIKAL   CIKK   ARTIKL	OZNAKA OZNAKA   MEGJELŐLÉS   OZNAČENÍ	D	EAN 13-ČRTNA KODA EAN 13-KODNA CRTA   EAN 13-KÓD SZÁM   ČÁROVÝ KÓD EAN 13	
002631R	S1 PE	40	3831111000842	
002632R	S4 PE	52	3831111000859	
002633R	S6 PE	68	3831111000866	

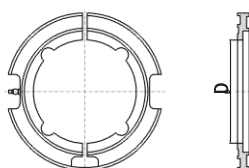

**LEŽAJ DZ PE**  
LEŽAJ DZ PE  
CSAPÁGY DZ PE  
LOŽISKA DZ PE

ARTIKEL ARTIKAL   CIKK   ARTIKL	OZNAKA OZNAKA   MEGJELŐLÉS   OZNAČENÍ	D	EAN 13-ČRTNA KODA EAN 13-KODNA CRTA   EAN 13-KÓD SZÁM   ČÁROVÝ KÓD EAN 13	
002948R	S4 DZ PE	116,5	3831111002716	

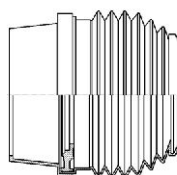

**OHIŠJE S KAPO**  
KUČIŠTE SA KAPOM  
BURKOLAT FEDÉLLEL  
KONCOVÁ OCHRANA



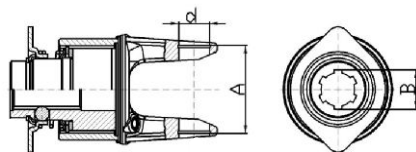









ARTIKEL ARTIKAL   CIKK   ARTIKL	OZNAKA OZNAKA   MEGJELŐLÉS   OZNAČENÍ	D	EAN 13-ČRTNA KODA EAN 13-KODNA CRTA   EAN 13-KÓD SZÁM   ČÁROVÝ KÓD EAN 13	
019580R	S4 DZ	139	3838433000222	



SKLOPKE | SPOJKE | TENGYELYKAPCSOLÓ | SPOJKY

PROSTOTEKOČA SKLOPKA PS/PSL



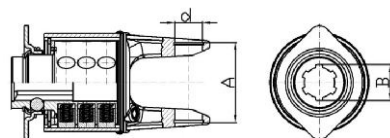

PROTOČNA SPOJKA PS/PSL  
SZABADONFUTÓ KUPLUNG PS/PSL  
VOLNOBĚŽNÁ SPOJKA PS/PSL

ARTIKEL ARTIKAL   CIKK   ARTIKL	OZNAKA OZNAKA   MEGJELŐLÉS   OZNAČENÍ	PROFIL B PROFIL B   FORMA B   PROFIL B	d	A	EAN 13 ČRTNA KODA EAN 13-KODNA CRTA   EAN 13-KÓD SZÁM   ČÁROVÝ KÓD EAN 13
002649R	S1 PS 1 3/8"z6	1 3/8"z6	22	57	3831111000910 
002651R	S1 PS 1 3/8"z21	1 3/8"z21	22	57	3831111000934 
002650R	S1 PSL 1 3/8"z6	1 3/8"z6	22	57	3831111000927 
002652R	S1 PSL 1 3/8"z21	1 3/8"z21	22	57	3831111000941 
002940R	S4 PS 1 3/8"z6	1 3/8"z6	27	77,4	3831111002631 
002655R	S4 PS 1 3/8"z21	1 3/8"z21	27	77,4	3831111000965 
002654R	S4 PSL 1 3/8"z6	1 3/8"z6	27	77,4	3831111000958 
002656R	S4 PSL 1 3/8"z21	1 3/8"z21	27	77,4	3831111000972 
002657R	S6 PS 1 3/8"z6	1 3/8"z6	30,2	94,4	3831111000989 
002659R	S6 PS 1 3/8"z21	1 3/8"z21	30,2	94,4	3831111001009 
002658R	S6 PSL 1 3/8"z6	1 3/8"z6	30,2	94,4	3831111000996 
002660R	S6 PSL 1 3/8"z21	1 3/8"z21	30,2	94,4	3831111001016 



VARNOŠTNA SKLOPKA VS

SIGURNOSNA SPOJKA VS  
BIZTONSÁGI KUPLUNG VS  
BEZPEČNOSTNÍ SPOJKA VS

ARTIKEL ARTIKAL   CIKK   ARTIKL	OZNAKA OZNAKA   MEGJELŐLÉS   OZNAČENÍ	PROFIL B PROFIL B   FORMA B   PROFIL B	d	A	EAN 13 ČRTNA KODA EAN 13-KODNA CRTA   EAN 13-KÓD SZÁM   ČÁROVÝ KÓD EAN 13
002661R	S1 VS 300Nm 1 3/8"z6	1 3/8"z6	22	57	3831111001023 
004435R	S1 VS 450Nm 1 3/8"z6	1 3/8"z6	22	57	3831111008268 
002941R	S4 VS 450Nm 1 3/8"z6	1 3/8"z6	27	77,4	3831111002648 
002942R	S4 VS 600Nm 1 3/8"z6	1 3/8"z6	27	77,4	3831111002655 
002943R	S4 VS 900Nm 1 3/8"z6	1 3/8"z6	27	77,4	3831111002662 



ARTIKEL ARTIKAL   CIKK   ARTIKL	OZNAKA OZNAKA   MEGJELŐLÉS   OZNAČENÍ	PROFIL B PROFIL B   FORMA B   PROFIL B	d	A	EAN 13-ČRTNA KODA EAN 13-KODNA CRTA   EAN 13-KÓD SZÁM   ČÁROVÝ KÓD EAN 13
003968R	S6 VS 900Nm 1 3/8"z6	1 3/8"z6	30,2	94,4	3831111007162
002665R	S6 VS1 1200Nm 1 3/8"z6	1 3/8"z6	30,2	94,4	3831111001030
002666R	S6 VS1 1500Nm 1 3/8"z6	1 3/8"z6	30,2	94,4	3831111001047

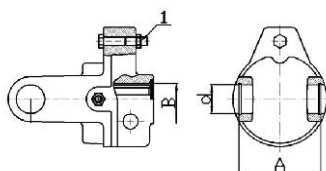

**STRIŽNA SKLOPKA ST**  
ODREZNA SPOJKA ST  
NYÍRÓCSAPOS KUPLUNG ST  
STŘIŽNÁ SPOJKA ST

ARTIKEL ARTIKAL   CIKK   ARTIKL	OZNAKA OZNAKA   MEGJELŐLÉS   OZNAČENÍ	PROFIL B PROFIL B   FORMA B   PROFIL B	d	A	EAN 13-ČRTNA KODA EAN 13-KODNA CRTA   EAN 13-KÓD SZÁM   ČÁROVÝ KÓD EAN 13
003030R	S4 ST 900Nm 1 3/8"z6	1 3/8"z6	27	77,4	3831111008558
003031R	S4 ST 1700Nm 1 3/8"z6	1 3/8"z6	27	77,4	3831111008565
003033R	S6 ST 2700Nm 1 3/8"z6	1 3/8"z6	30,2	94,4	3831111008589
003034R	S6 ST 2700Nm 1 3/4"z6	1 3/4"z6	30,2	94,4	3831111008596

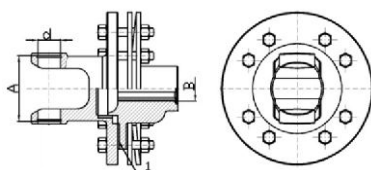

**TORNA SKLOPKA TS**  
TARNA SPOJKA TS  
SÚRLÓDÓ KUPLUNG TS  
TŘECÍ SPOJKA TS

ARTIKEL ARTIKAL   CIKK   ARTIKL	OZNAKA OZNAKA   MEGJELŐLÉS   OZNAČENÍ	PROFIL B PROFIL B   FORMA B   PROFIL B	d	A	EAN 13-ČRTNA KODA EAN 13-KODNA CRTA   EAN 13-KÓD SZÁM   ČÁROVÝ KÓD EAN 13
003050R	S4 TS 800Nm 1 3/8"z6	1 3/8"z6	27	77,4	3831111008633
003051R	S6 TS 900Nm 1 3/8"z6	1 3/8"z6	30,2	94,4	3831111008640
003052R	S6 TS 1200Nm 1 3/8"z6	1 3/8"z6	30,2	94,4	3831111008657
003053R	S6 TS 1200Nm 1 3/4"z6	1 3/4"z6	30,2	94,4	3831111008664
003056R	S6 TS PS 1200Nm 1 3/8"z6	1 3/8"z6	30,2	94,4	3831111008688

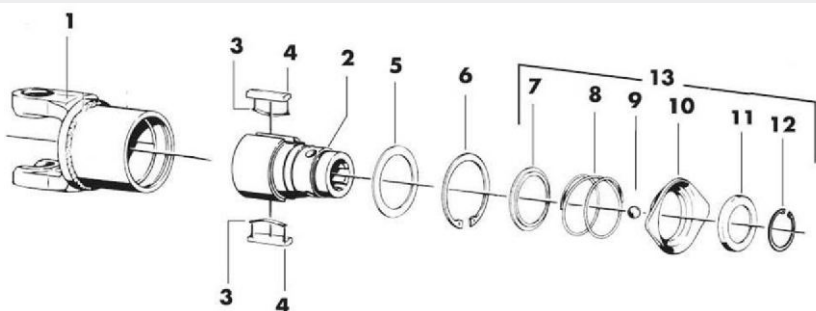

KOMPONENTE SKLOPK  
DIJELOVI SPOJKE  
TENGYELKAPCSOLÓK ALKATRÉSZEI  
ČÁSTI SPOJEK

PS  
PS  
PS  
PS

ARTIKEL ARTIKAL   CIKK   ARTIKL	POZ.	OZNAKA OZNAKA   MEGJELŐLÉS   OZNAČENÍ	ZA SKLOPKO   ZA SPOJKU   A TENGYELKAPCSOLÓ   PRO SPOJKY	EAN 13 ČRTNA KODA EAN 13-KODNA CRTA   EAN 13-KÓD SZÁM   ČÁROVÝ KÓD EAN 13
002698R	1	Ohišje sklopke 1 PS   Čahura spojke   Tengelykapcsoló háza   Plášť spojky	1 PS	3831111001337
002699R	1	Ohišje sklopke 1 PSL   Čahura spojke   Tengelykapcsoló háza   Plášť spojky	1 PSL	3831111001344
002700R	1	Ohišje sklopke S4 PS   Čahura spojke   Tengelykapcsoló háza   Plášť spojky	S4 PS	3831111001351
002701R	1	Ohišje sklopke S4 PSL   Čahura spojke   Tengelykapcsoló háza   Plášť spojky	S4 PSL	3831111001368
002702R	1	Ohišje sklopke 6 PS   Čahura spojke   Tengelykapcsoló háza   Plášť spojky	6 PS	3831111001375
002703R	1	Ohišje sklopke 6 PSL   Čahura spojke   Tengelykapcsoló háza   Plášť spojky	6 PSL	3831111001382
002710R	2	Jedro PS 1 3/8"z6   Jezgro   Mag   Jádros   1 3/8"z6	PS	3831111001443
002718R	3	Vzmet listnata PS   Opruga   Rugó   Pružina	PS	3831111001511
020605R	3	Vzmet listnata PS   Opruga   Rugó   Pružina <b>10</b> kos/kom/db/ks	PS	3838433002691
020606R	3	Vzmet listnata PS   Opruga   Rugó   Pružina <b>50</b> kos/kom/db/ks	PS	3838433002707
002717R	4	Zob PS   Zub   Fog   Zub	PS	3831111001504
020603R	4	Zob PS   Zub   Fog   Zub <b>10</b> kos/kom/db/ks	PS	3838433002677
020604R	4	Zob PS   Zub   Fog   Zub <b>50</b> kos/kom/db/ks	S	3838433002684
002719R	5	Distančník   Distančník   Csapágypersely   Distanční kroužek	D 12,7	3831111001528
002720R	6	Vskočník   Varovalni prsten   Rögzítőgyűrű   Ségrovka	S	3831111001535
020512R	6	Vskočník   Varovalni prsten   Rögzítőgyűrű   Ségrovka <b>10</b> kos/kom/db/ks	S	3838433002493
002721R	7	Obroč zaštitni   Obruč zaštitni   Védőgyűrű   Ochranný kroužek	S	3831111001542
002724R	8	Vzmet potisna   Opruga   Nyomórugó   Tlačná pružina		3831111001573
020507R	8	Vzmet potisna   Opruga   Nyomórugó   Tlačná pružina <b>10</b> kos/kom/db/ks		3838433002448
002722R	9	Kroglica   Kuglica   Golyó   Kulička <b>3</b> kos/kom/db/ks		3831111001559
020509R	9	Kroglica   Kuglica   Golyó   Kulička <b>100</b> kos/kom/db/ks		3838433002462

ARTIKEL ARTIKAL   CIKK   ARTIKL	POZ.	OZNAKA OZNAKA   MEGJELŐLÉS   OZNAČENÍ	ZA SKLOPKO   ZA SPOJKU   A TENGELYKAPCSOLÓ   PRO SPOJKY	EAN 13 ČRTNA KODA EAN 13-KODNA CRTA   EAN 13-KÓD SZÁM   ČÁROVÝ KÓD EAN 13
002723R	10	Plošča snemalna   Ploča priključ, meh.   Levehető csapágyfedél   Snímací destička		3831111001566 
020510R	10	Plošča snemalna   Ploča priključ, meh.   Levehető csapágyfedél   Snímací destička <b>10</b> kos/kom/db/ks		3838433002479 
002725R	11	Obroč kotni   Obruč kutni   Sarokgyűrű   Úhlový kroužek		3831111001580 
020511R	11	Obroč kotni   Obruč kutni   Sarokgyűrű   Úhlový kroužek <b>10</b> kos/kom/db/ks		3838433002486 
002726R	12	Vskočnik   Varovalni prsten   Rögzítőgyűrű íne   Ségrovka		3831111001597 
020512R	12	Vskočnik   Varovalni prsten   Rögzítőgyűrű íne   Ségrovka <b>10</b> kos/kom/db/ks		3838433002493 
003250R	13	Priključni mehanizem   Priključ, mehanizam   Rögzítő rendszer   Připojovací mechanismus		3831111004802 

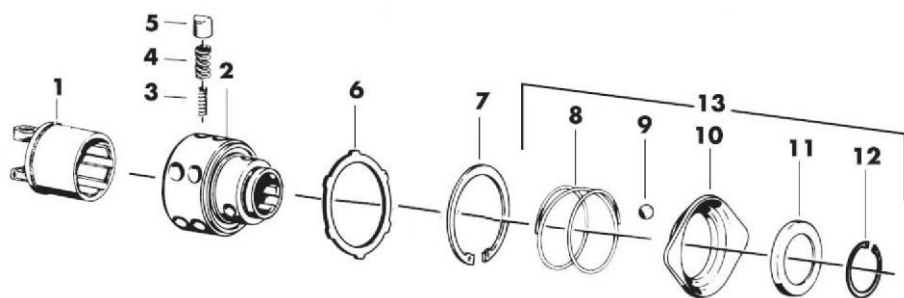

KOMPONENTE SKLOPK  
DIJELOVI SPOJKE  
TENGYELKAPCSOLÓK ALKATRÉSZEI  
ČÁSTI SPOJEK

VS  
VS  
VS  
VS

ARTIKEL ARTIKAL   CIKK   ARTIKL	POZ.	OZNAKA OZNAKA   MEGJELŐLÉS   OZNAČENÍ	ZA SKLOPKO   ZA SPOJKU   A TENGYELKAPCSOLÓ   PRO SPOJKY	EAN 13 ČRTNA KODA EAN 13-KODNA CRTA   EAN 13-KÓD SZÁM   ČÁROVÝ KÓD EAN 13	
002704R	1	Ohišje sklopke 1 VS 360Nm   Čahura spojke   Tengelykapcsoló háza   Plášť spojky	1 VS 360Nm	3831111001399	
002705R	1	Ohišje sklopke S4 VS 720Nm   Čahura spojke   Tengelykapcsoló háza   Plášť spojky	S4 VS 720Nm	3831111001405	
002706R	1	Ohišje sklopke S4 VS 1080Nm   Čahura spojke   Tengelykapcsoló háza   Plášť spojky	S4 VS 1080Nm	3831111001412	
002707R	1	Ohišje sklopke S4 VS 1440Nm   Čahura spojke   Tengelykapcsoló háza   Plášť spojky	S4 VS 1440Nm	3831111001429	
002708R	1	Ohišje sklopke 6 VS 1440Nm   Čahura spojke   Tengelykapcsoló háza   Plášť spojky	6 VS 1440Nm	3831111001436	
002712R	2	Jedro VS 360Nm 1 3/8"z6   Jezgro   Mag   Jádó   1 3/8"z6	VS 360Nm	3831111001467	
002713R	2	Jedro VS 720Nm 1 3/8"z6   Jezgro   Mag   Jádó   1 3/8"z6	VS 720Nm	3831111001474	
002714R	2	Jedro VS 1080Nm 1 3/8"z6   Jezgro   Mag   Jádó   1 3/8"z6	VS 1080Nm	3831111001481	
002715R	2	Jedro VS 1440Nm 1 3/8"z6   Jezgro   Mag   Jádó   1 3/8"z6	VS 1440Nm	3831111001498	
002727R	3	Zob VS   Zub   Fog   Zub	VS	3831111001603	
020599R	3	Zob VS   Zub   Fog   Zub <b>6</b> kos/kom/db/ks	VS	3838433002639	
020601R	3	Zob VS   Zub   Fog   Zub <b>8</b> kos/kom/db/ks	VS	3838433002653	
020600R	3	Zob VS   Zub   Fog   Zub <b>100</b> kos/kom/db/ks	VS	3838433002646	
020602R	3	Zob VS1   Zub   Fog   Zub <b>100</b> kos/kom/db/ks	VS1	3838433002660	
002728R	4	Vzmet zunanja   Opruga vanjska   Külső rugó   Vnější pružina		3831111001610	
020513R	4	Vzmet zunanja VS   Opruga vanjska   Külső rugó   Vnější pružina <b>8</b> kos/kom/db/ks	VS	3838433002509	
020514R	4	Vzmet zunanja VS   Opruga vanjska   Külső rugó   Vnější pružina <b>100</b> kos/kom/db/ks	VS	3838433002516	
002729R	5	Vzmet notranja   Opruga unutrašnja   Belső rugó   Vnitřní pružina		3831111001627	
020597R	5	Vzmet notranja VS   Opruga unutrašnja   Belső rugó   Vnitřní pružina <b>8</b> kos/kom/db/ks	VS	3838433002615	
020598R	5	Vzmet notranja VS   Opruga unutrašnja   Belső rugó   Vnitřní pružina <b>100</b> kos/kom/db/ks	VS	3838433002622	
002730R	6	Zapirni obroč   Obruč zatv.   Zárógyűrű   Závěrný kroužek		3831111001634	

ARTIKEL ARTIKAL   CIKK   ARTIKL	POZ.	OZNAKA OZNAKA   MEGJELŐLÉS   OZNAČENÍ	ZA SKLOPKO   ZA SPOJKU   A TENGELYKAPCSOLÓ   PRO SPOJKY	EAN 13-ČRTNA KODA EAN 13-KODNA CRTA   EAN 13-KÓD SZÁM   ČÁROVÝ KÓD EAN 13
002731R	7	Vskočnik   Varovalni prsten   Rögztőgyűrű   Ségrovka	VS	3831111001641
002724R	8	Vzmet potisna   Opruga   Nyomórugó   Tlačná pružina	VS	3831111001573
020507R	8	Vzmet potisna   Opruga   Nyomórugó   Tlačná pružina	<b>10</b> kos/kom/db/ks VS	3838433002448
002722R	9	Kroglica   Kuglica   Golyó   Kulička	<b>3</b> kos/kom/db/ks VS	3831111001559
020823R	9	Kroglica   Kuglica   Golyó   Kulička	<b>100</b> kos/kom/db/ks VS1	3838433002462
002723R	10	Plošča snemalna   Ploča priključ. meh.   Levehető csapágyfedél   Snímací destička		3831111001566
020510R	10	Plošča snemalna   Ploča priključ. meh.   Levehető csapágyfedél   Snímací destička	<b>10</b> kos/kom/db/ks VS	3838433002479
002725R	11	Obroč kotni   Obruč kutni   Sarokgyűrű   Úhlový kroužek	VS	3831111001580
020511R	11	Obroč kotni   Obruč kutni   Sarokgyűrű   Úhlový kroužek	<b>10</b> kos/kom/db/ks VS	3838433002486
002726R	12	Vskočnik   Varovalni prsten   Rögztőgyűrű iné   Ségrovka	VS	3831111001597
020512R	12	Vskočnik   Varovalni prsten   Rögztőgyűrű iné   Ségrovka	<b>10</b> kos/kom/db/ks VS	3838433002493
003250R	13	Priključni mehanizem   Priključ. mehanizam   Rögztő rendszer   Připojovací mechanismus		3831111004802

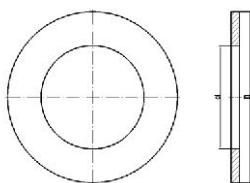

LAMELA  
LAMELA  
LAMELLA  
LAMELA

ARTIKEL ARTIKAL   CIKK   ARTIKL	OZNAKA OZNAKA   MEGJELŐLÉS   OZNAČENÍ	EAN 13-ČRTNA KODA EAN 13-KODNA CRTA   EAN 13-KÓD SZÁM   ČÁROVÝ KÓD EAN 13
019497R	TS D124 d67	3838433000123
011518R	TS D141 d77	3831111035158
019498R	TS D162 d85	3838433000130
004015R	TS-PS D140 d85	3831111007285
004016R	TS-PS D160 d97	3831111007292



**VELIKOST**

VELIČINA |  
NAGYSÁG | VELIKOST

**KARDANSKI KRIŽ**

KARDANSKI KRIŽ |  
KARDÁN KERESZT | KARDANOVÝ KŘÍŽ

**ZUNANJA CEV**

VANJSKA CIJEV |  
KÜLSŐ CSŐ | VNĚJŠÍ TRUBKA

**NOTRANJA CEV**

UNUTRAŠNJA CIJEV |  
BELSŐ CSŐ | VNITŘNÍ TRUBKA

**1**

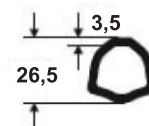
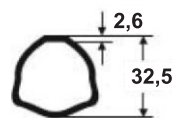
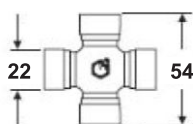

**2**

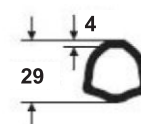
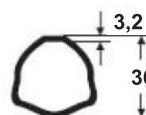
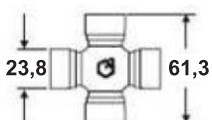

**4**

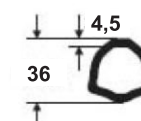
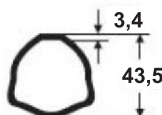
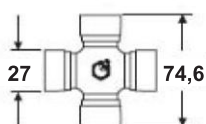

**5**

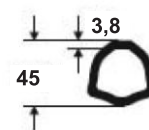
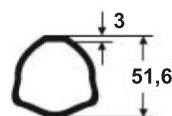
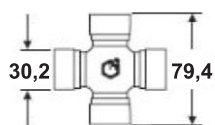

**6**

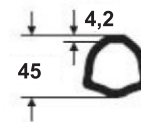
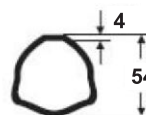
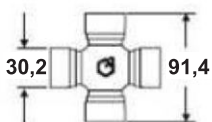

**8**

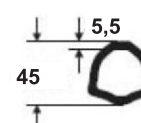
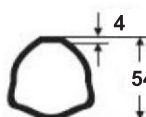
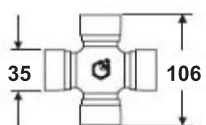

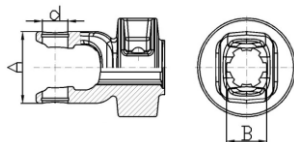

**VILICA PRIKLJUČNA**  
 PRIKLJUČNA VILICA  
 KAPCSOLÓ VILLÁK  
 VIDLICE PŘIPOJOVACÍ

ARTIKEL ARTIKAL   CIKK   ARTIKL	OZNAKA OZNAKA   MEGJELÖLÉS   OZNAČENÍ	PROFIL B PROFIL B   FORMA B   PROFIL B	d	A	EAN 13-ČRTNA KODA EAN 13-KODNA CRTA   EAN 13-KÓD SZÁM   ČÁROVÝ KÓD EAN 13	
003000R	Q1 1 3/8"z6	1 3/8"z6	22	56	3831111003003	
003001R	Q2 1 3/8"z6	1 3/8"z6	23,8	63,7	3831111003010	
003002R	Q3 1 3/8"z6	1 3/8"z6	27	72	3831111003027	
003003R	Q4 1 3/8"z6	1 3/8"z6	27	77	3831111003034	
003004R	Q5 1 3/8"z6	1 3/8"z6	30,2	82,4	3831111003041	
003005R	Q6 1 3/8"z6	1 3/8"z6	30,2	94,4	3831111003058	
003006R	Q8 1 3/8"z6	1 3/8"z6	35	109,5	3831111003065	

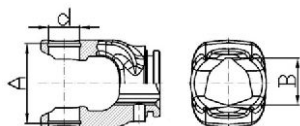

**VILICA CEVNA**  
 CIJEVNA VILICA  
 CSŐ VILLÁK  
 TRUBKOVÁ VIDLICE

ARTIKEL ARTIKAL   CIKK   ARTIKL	OZNAKA OZNAKA   MEGJELŐLÉS   OZNAČENÍ	PROFIL B PROFIL B   FORMA B   PROFIL B	d	A		EAN 13 ČRTNA KODA EAN 13-KODNA CRTA   EAN 13-KÓD SZÁM   ČÁROVÝ KÓD EAN 13
003007R	Q1 TZ	32,5	22	56	3831111003072	
003008R	Q1 TN	26,5	22	56	3831111003089	
003009R	Q2 TZ	36	23,8	63,7	3831111003096	
003010R	Q2 TN	29	23,8	63,7	3831111003102	
003011R	Q3 TZ	43,5	27	72	3831111003119	
003012R	Q3 TN	36	27	72	3831111003126	
003013R	Q4 TZ	43,5	27	77	3831111003133	
003014R	Q4 TN	36	27	77	3831111003140	
003015R	Q5 TZ	51,6	30,2	82,4	3831111003157	
003016R	Q5 TN	45	30,2	82,4	3831111003164	
003017R	Q6 TZ	54	30,2	94,4	3831111003171	
003018R	Q6 TN	45	30,2	94,4	3831111003188	
003019R	Q8 TZ	54	35	109,5	3831111003195	
003020R	Q8 TN	45	35	109,5	3831111003201	



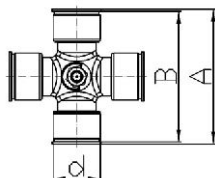

KRÍŽ  
KRIŽ  
KERESZTEK  
KŘÍŽ

ARTIKEL ARTIKAL   CIKK   ARTIKL	OZNAKA OZNAKA   MEGJELÖLÉS   OZNAČENÍ	(D×B1) DIMENZUJE   DIMENZUJE   MÉRETEK   ROZMĚRY	d	A	EAN 13 ČRTNA KODA EAN 13-KODNA CRTA   EAN 13-KÓD SZÁM   ČÁROVÝ KÓD EAN 13	
003021R	Q1	22x54	22	56	3831111003218	
003022R	Q2	23,8x61,3	23,8	63,7	3831111003225	
003023R	Q3	27x70	27	72	3831111003232	
003024R	Q4	27x74,6	27	77	3831111003249	
003025R	Q5	30,2x79,4	30,2	82,4	3831111003256	
003026R	Q6	30,2x91,4	30,2	94,4	3831111003263	
003027R	Q8	35x106	35	109,5	3831111003270	

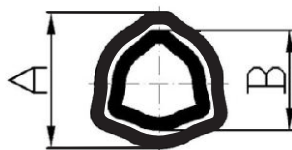







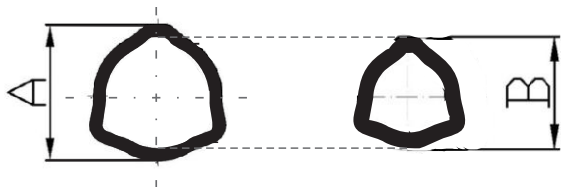





KOVINSKE CEVI T KOMPL  
 ČELIČNE CIJEVI T KOMPL.  
 FÉMCSÖVEK T KOMPL.  
 KOVOVÁ TRUBKA T KOMPL.

ARTIKEL ARTIKAL   CIKK   ARTIKL	OZNAKA OZNAKA   MEGJELÖLÉS   OZNAČENÍ	DOLŽINA DUŽINA   HOSSZÚSÁG   DÉLKA	PROFIL (A/B)	EAN 13 ČRTNA KODA EAN 13-KODNA CRTA   EAN 13-KÓD SZÁM   ČÁROVÝ KÓD EAN 13
002501R	1 T kpl L500	L500	32,5/26,5	3831111000231
002502R	1 T kpl L750	L750	32,5/26,5	3831111000248
002506R	1 T kpl L1000	L1000	32,5/26,5	3831111000279
003969R	1 T kpl L1500	L1500	32,5/26,5	3831111007179
003972R	1 T kpl L2000	L2000	32,5/26,5	3831111007193
002507R	1 T kpl L3000	L3000	32,5/26,5	3831111000286
002791R	2 T kpl L500	L500	36/29	3831111002198
002792R	2 T kpl L750	L750	36/29	3831111002204
002796R	2 T kpl L1000	L1000	36/29	3831111002242
004140R	2 T kpl L1500	L1500	36/29	3831111007513
004141R	2 T kpl L2000	L2000	36/29	3831111007520
002797R	2 T kpl L3000	L3000	36/29	3831111002259
002509R	4 T kpl L500	L500	43,5/36,5	3831111000309
002512R	4 T kpl L750	L750	43,5/36,5	3831111000330
002514R	4 T kpl L1000	L1000	43,5/36,5	3831111000354
003479R	4 T kpl L1500	L1500	43,5/36,5	3831111006783
003480R	4 T kpl L2000	L2000	43,5/36,5	3831111006790
002515R	4 T kpl L3000	L3000	43,5/36,5	3831111000361
002799R	5 T kpl L500	L500	51,5/45	3831111002273
002800R	5 T kpl L750	L750	51,5/45	3831111002280
002853R	5 T kpl L1000	L1000	51,5/45	3831111002327
004146R	5 T kpl L1500	L1500	51,5/45	3831111007575

ARTIKEL ARTIKAL   CIKK   ARTIKL	OZNAKA OZNAKA   MEGJELŐLÉS   OZNAČENÍ	DOLŽINA DUŽINA   HOSSZÚSÁG   DÉLKA	PROFIL (A/B)	EAN 13-ČRTNA KODA EAN 13-KODNA CRTA   EAN 13-KÓD SZÁM   ČÁROVÝ KÓD EAN 13	
004147R	5 T kpl L2000	L2000	51,5/45	3831111007582	
002854R	5 T kpl L3000	L3000	51,5/45	3831111002334	
002516R	6 T kpl L500	L500	53,5/45,5	3831111000378	
002518R	6 T kpl L750	L750	53,5/45,5	3831111000392	
002520R	6 T kpl L1000	L1000	53,5/45,5	3831111000415	
003251R	6 T kpl L1500	L1500	53,5/45,5	3831111004819	
003975R	6 T kpl L2000	L2000	53,5/45,5	3831111007223	
002521R	6 T kpl L3000	L3000	53,5/45,5	3831111000422	
002856R	8 T kpl L500	L500	54/45,5	3831111002358	
002857R	8 T kpl L750	L750	54/45,5	3831111002365	
002944R	8 T kpl L1000	L1000	54/45,5	3831111002679	
004162R	8 T kpl L1500	L1500	54/45,5	3831111007681	
004163R	8 T kpl L2000	L2000	54/45,5	3831111007698	
002945R	8 T kpl L3000	L3000	54/45,5	3831111002686	



KOVINSKA CEV Z/N  
 ČELIČNA CIJEV Z/N  
 FÉMCSÖVEK Z/N  
 KOVOVÁ TRUBKA Z/N

ARTIKEL ARTIKAL   CIKK   ARTIKL	OZNAKA OZNAKA   MEGJELÖLÉS   OZNAČENÍ	DOLŽINA DUŽINA   HOSSZÚSÁG   DÉLKA	PROFIL (A/B)	EAN 13 ČRTNA KODA EAN 13-KODNA CRTA   EAN 13-KÓD SZÁM   ČÁROVÝ KÓD EAN 13
002528R	1 TZ L3000	L3000	32,5	3831111000491 
002548R	1 TN L3000	L3000	26,5	3831111000699 
002680R	2 TZ L3000	L3000	36	3831111001184 
002774R	2 TN L3000	L3000	29	3831111002037 
002535R	4 TZ L3000	L3000	43,5	3831111000569 
002555R	4 TN L3000	L3000	36,5	3831111000767 
002738R	5 TZ L3000	L3000	51,5	3831111001719 
002781R	5 TN L3000	L3000	45	3831111002105 
002541R	6 TZ L3000	L3000	53,5	3831111000620 
002561R	6 TN L3000	L3000	45,5	3831111000828 
002749R	8 TZ L3000	L3000	54	3831111001788 
002788R	8 TN L3000	L3000	45,5	3831111002174 

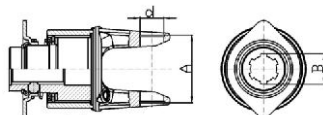

**SKLOPKE**  
SPOJKE  
TENGYELYPACSOLO  
SPOJKY

**PROSTOTEKOČA SKLOPKA PS**  
PROTOČNA SPOJKA PS  
SZABADONFUTÓ KUPLUNG PS  
VOLNOBĚŽNÁ SPOJKA PS

ARTIKEL ARTIKAL   CIKK   ARTIKL	OZNAKA OZNAKA   MEGJELŐLÉS   OZNAČENÍ	PROFIL PROFIL   FORMA   PROFIL	d	A	EAN 13 ČRTNA KODA EAN 13-KODNA CRTA   EAN 13-KÓD SZÁM   ČÁROVÝ KÓD EAN 13	
003306R	Q1 PS	1 3/8"xz6	22	56	3831111005182	
003307R	Q1 PS	1 3/8"xz21	22	56	3831111005199	
003308R	Q1 PSL	1 3/8"xz6	22	56	3831111005205	
003309R	Q1 PSL	1 3/8"xz21	22	56	3831111005212	
004436R	Q2 PS	1 3/8"xz6	23,8	63,7	3831111008275	
003310R	Q4 PS	1 3/8"xz6	27	77	3831111005229	
003311R	Q4 PS	1 3/8"xz21	27	77	3831111005236	
003312R	Q4 PSL	1 3/8"xz6	27	77	3831111005243	
003313R	Q4 PSL	1 3/8"xz21	27	77	3831111005250	
019432R	Q6 PS	1 3/8"xz6	30,2	94,4	3831111099723	
019434R	Q6 PS	1 3/8"xz21	30,2	94,4	3831111099747	
019433R	Q6 PSL	1 3/8"xz6	30,2	94,4	3831111099730	
019435R	Q6 PSL	1 3/8"xz21	30,2	94,4	3831111099754	
003048R	Q8 PS	1 3/8"xz6	35	109,5	3831111003287	

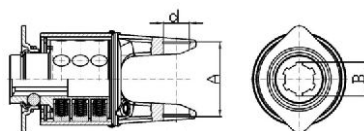

**VARNOSTNA SKLOPKA VS**

SIGURNOSNA SPOJKA VS  
BIZTONSÁGI KUPLUNG VS  
BEZPEČNOSTNÍ SPOJKA VS

ARTIKEL ARTIKAL   CIKK   ARTIKL	OZNAKA OZNAKA   MEGJELÖLÉS   OZNAČENÍ	PROFIL PROFIL   FORMA   PROFIL	d	A	EAN 13 ČRTNA KODA EAN 13-KODNA CRTA   EAN 13-KÓD SZÁM   ČÁROVÝ KÓD EAN 13	
003314R	Q1 VS 300Nm	1 3/8"z6	22	56	3831111005267	
003315R	Q4 VS 450Nm	1 3/8"z6	27	77	3831111005274	
003316R	Q4 VS 600Nm	1 3/8"z6	27	77	3831111005281	
003317R	Q4 VS 900Nm	1 3/8"z6	27	77	3831111005298	
003318R	Q4 VS1 1200Nm	1 3/8"z6	27	77	3831111005304	

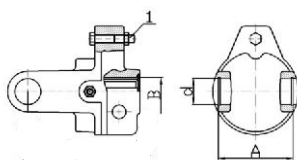

**STRIŽNA SKLOPKA ST**

ODREZNA SPOJKA ST  
NYÍRÓCSAPOK KUPLUNG ST  
STŘIŽNÁ SPOJKA ST

ARTIKEL ARTIKAL   CIKK   ARTIKL	OZNAKA OZNAKA   MEGJELÖLÉS   OZNAČENÍ	PROFIL PROFIL   FORMA   PROFIL	d	A	EAN 13 ČRTNA KODA EAN 13-KODNA CRTA   EAN 13-KÓD SZÁM   ČÁROVÝ KÓD EAN 13	
003028R	Q1 ST 700Nm	1 3/8"z6	22	56	3831111008534	
003029R	Q2 ST 950Nm	1 3/8"z6	23,8	63,7	3831111008541	
019436R	Q4 ST 900Nm	1 3/8"z6	27	77	3831111099761	
019437R	Q4 ST 1700Nm	1 3/8"z6	27	77	3831111099778	
003032R	Q5 ST 2400Nm	1 3/8"z6	30,2	82,4	3831111008572	
019438R	Q6 ST 2700Nm	1 3/8"z6	30,2	94,4	3831111099785	
019439R	Q6 ST 2700Nm	1 3/4"z6	30,2	94,4	3831111099792	
019440R	Q8 ST 3000Nm	1 3/8"z6	35	109,5	3831111099808	
019441R	Q8 ST 3000Nm	1 3/4"z6	35	109,5	3831111099815	

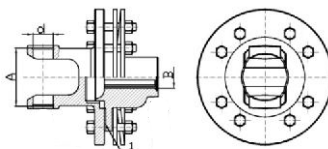

**TORNA SKLOPKA TS**  
TARNA SPOJKA TS  
SÚRLÓDÓ KUPLUNG TS  
TŘECÍ SPOJKA TS

ARTIKEL ARTIKAL   CIKK   ARTIKL	OZNAKA OZNAKA   MEGJELÖLÉS   OZNAČENÍ	PROFIL PROFIL   FORMA   PROFIL	d	A	EAN 13-ČRTNA KODA EAN 13-KODNA CRTA   EAN 13-KÓD SZÁM   ČÁROVÝ KÓD EAN 13	
019442R	Q4 TS 800Nm	1 3/8"z6	27	77	3831111099822	
019443R	Q6 TS 900Nm	1 3/8"z6	30,2	94,4	3831111099839	
019444R	Q6 TS 1200Nm	1 3/8"z6	30,2	94,4	3831111099846	
019445R	Q6 TS 1200Nm	1 3/4"z6	30,2	94,4	3831111099853	
019446R	Q8 TS 1800Nm	1 3/8"z6	35	109,5	3831111099860	
019447R	Q8 TS 1800Nm	1 3/4"z6	35	109,5	3831111099877	

**VELIKOST**  
VELIČINA |  
NAGYSÁG | VELIKOST

**KARDANSKI KRIŽ**  
KARDANSKI KRIŽ |  
KARDÁN KERESZT | KARDANOVÝ KŘÍŽ

**ZUNANJA CEV**  
VANJSKA CEV |  
KÜLSŐ CSŐ | VNĚJŠÍ TRUBKA

**NOTRANJA CEV**  
UNUTRAŠNJA CEV |  
BELSÓ CSŐ | VNITŘNÍ TRUBKA

**21**

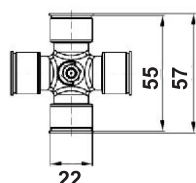

21AZ

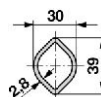

21AN

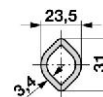

21BZ

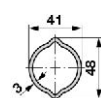

21BN

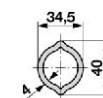

**22**

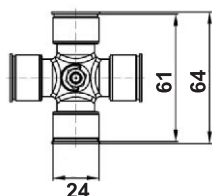

22AZ

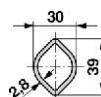

22AN

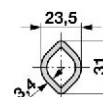

22BZ

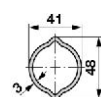

22BN



**23**

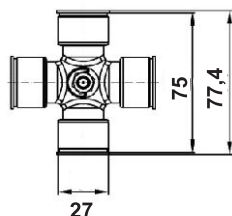

23AZ

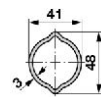

23AN

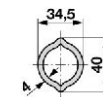

23BZ

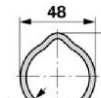

23BN

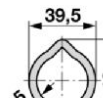

**24**

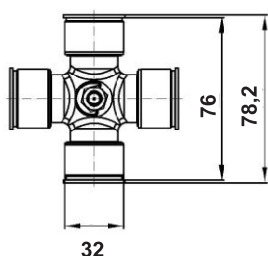

24AZ

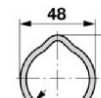

24AN

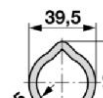

24BZ

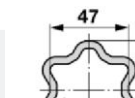

24BN

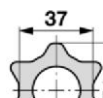

**25**

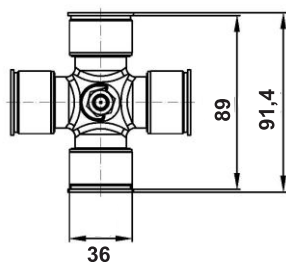

25Z

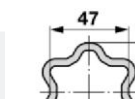

25N

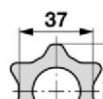



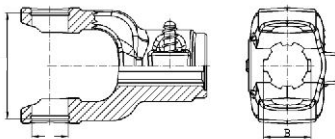

**VILICA PRIKLJUČNA**  
PRIKLJUČNA VILICA  
KAPCSOLÓ VILLÁK  
VIDLICE PŘIPOJOVACÍ

ARTIKEL ARTIKAL   CIKK   ARTIKL	OZNAKA OZNAKA   MEGJELÖLÉS   OZNAČENÍ	PROFIL B PROFIL B   FORMA B   PROFIL B	d	A	EAN 13 ČRTNA KODA EAN 13-KODNA CRTA   EAN 13-KÓD SZÁM   ČÁROVÝ KÓD EAN 13	
019400R	21 1 3/8"z6	1 3/8"z6	22	57	3831111099457	
019401R	21 1 3/8"z21	1 3/8"z21	22	57	3831111099464	
019402R	22 1 3/8"z6	1 3/8"z6	24	64	3831111099471	
019403R	22 1 3/8"z21	1 3/8"z21	24	64	3831111099488	
019404R	23 1 3/8"z6	1 3/8"z6	27	77,4	3831111099495	
019405R	23 1 3/8"z21	1 3/8"z21	27	77,4	3831111099501	
003385R	24 1 3/8"z6	1 3/8"z6	32	78,2	3831111005892	
004758R	24 1 3/8"z21	1 3/8"z21	32	78,2	3831111008824	
004050R	24 1 3/4"z6	1 3/4"z6	32	78,2	3831111007322	
012875R	25 1 3/8"z6	1 3/8"z6	36	92,3	3831111041852	

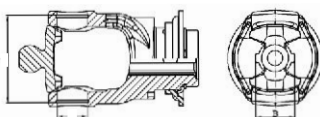

**VILICA PRIKLJUČNA DZ SNM**  
PRIKLJUČNA VILICA DZ SNM  
VILLÁK KAPCSOLÓ DZ SNM  
VIDLICE PŘIPOJOVACÍ DZ SNM

019426R	23 DZ 1 3/8"z6	1 3/8"z6	27	77,4	3831111099693	
019427R	23 DZ 1 3/8"z21	1 3/8"z21	27	77,4	3831111099709	

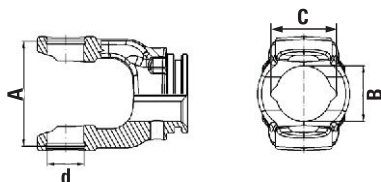

VILICA CEVNA  
CIJEVNA VILICA  
CSŐ VILLÁK  
VIDLICE TRUBKOVÁ

ARTIKEL ARTIKAL   CIKK   ARTIKL	OZNAKA OZNAKA   MEGJELÖLÉS   OZNAČENÍ	d	A	PROFIL B		C	EAN 13 ČRTNA KODA	
				PROFIL B   FORMA B	PROFIL B		EAN 13-KODNA CRTA   EAN 13-KÓD SZÁM   ČÁROVÝ KÓD EAN 13	
003386R	21 AN	22	57	◇	23,5	31	3831111005908	
003387R	21 AZ	22	57	◇	30	39	3831111005915	
019367R	21 BN	22	57	○	34,5	40	3831111099235	
019368R	21 BZ	22	57	○	41	48	3831111099242	
003388R	22 AN	24	64	◇	23,5	31	3831111005922	
003389R	22 AZ	24	64	◇	30	39	3831111005939	
018786R	22 BN	24	64	○	34,5	40	3831111099440	
019369R	22 BZ	24	64	○	41	48	3831111099259	
003390R	23 AN	27	77,4	○	34,5	40	3831111005946	
003391R	23 AZ	27	77,4	○	41	48	3831111005953	
012869R	23 BN	27	77,4	○	39,5	49	3831111041791	
012870R	23 BZ	27	77,4	○	48	57,5	3831111041807	
003392R	24 AN	32	78,2	○	39,5	49	3831111005960	
003393R	24 AZ	32	78,2	○	48	57,5	3831111005977	
012871R	24 BN	32	78,2	☆	37	51	3831111041814	
012872R	24 BZ	32	78,2	☆	47	61	3831111041821	
012876R	25 N	36	92,3	☆	37	51	3831111041869	
012877R	25 Z	36	92,3	☆	47	61	3831111041876	

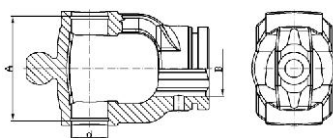
 VILICA CEVNA DZ  
 CIJEVNA VILICA DZ  
 CSŐ VILLÁK DZ  
 TRUBKOVÁ VIDLICE DZ

ARTIKEL ARTIKAL   CIKK   ARTIKL	OZNAKA OZNAKA   MEGJELŐLÉS   OZNAČENÍ	PROFIL B PROFIL B   FORMA B   PROFIL B	d	A	EAN 13 ČRTNA KODA EAN 13-KODNA CRTA   EAN 13-KÓD SZÁM   ČÁROVÝ KÓD EAN 13	
002970R	23 DZ AZ	41	27	77,4	3831111002815	
002971R	23 DZ AN	34,5	27	77,4	3831111002822	

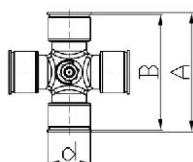
 KRIŽ L  
 KRIŽ L  
 KERESZTEK L  
 KRÍŽ L

ARTIKEL ARTIKAL   CIKK   ARTIKL	OZNAKA OZNAKA   MEGJELŐLÉS   OZNAČENÍ	(d×B) DIMENZJE   DIMENZJE   MÉRETEK   ROZMÉRY	(d×A) DIMENZJE   DIMENZJE   MÉRETEK   ROZMÉRY	EAN 13 ČRTNA KODA EAN 13-KODNA CRTA   EAN 13-KÓD SZÁM   ČÁROVÝ KÓD EAN 13	
019416R	21	22x55	22x57	3831111099600	
019417R	22	24x61	24x64	3831111099617	
019418R	23	27x75	27x77,4	3831111099624	
003451R	24	32x76	32x78,2	3831111006516	
019702R	25	36x89	36x91,2	3838433000437	

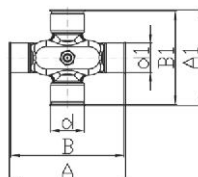

 KRIŽ L DZ  
 KRIŽ L DZ  
 KERESZTEK L DZ  
 KRÍŽ L DZ

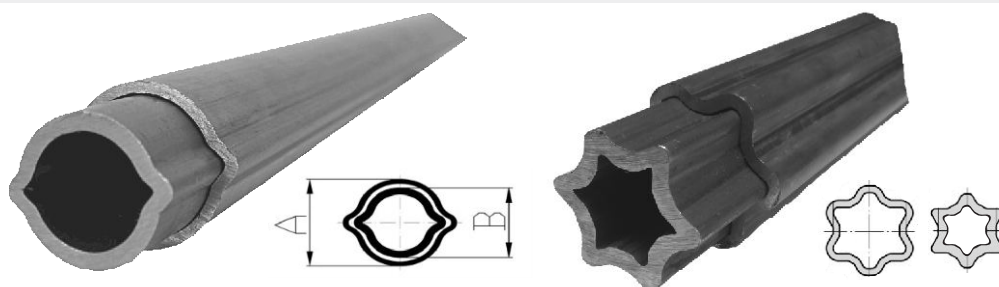
ARTIKEL ARTIKAL   CIKK   ARTIKL	OZNAKA OZNAKA   MEGJELŐLÉS   OZNAČENÍ	(d×B1/d1×B) DIMENZJE   DIMENZJE   MÉRETEK   ROZMÉRY	(d×A1/d1×A) DIMENZJE   DIMENZJE   MÉRETEK   ROZMÉRY	EAN 13 ČRTNA KODA EAN 13-KODNA CRTA   EAN 13-KÓD SZÁM   ČÁROVÝ KÓD EAN 13	
019698R	22 DZ	24x61/22x76	24x64/22x78	3838433000406	
019419R	23 DZ	27x75/23,8x91,2	27x77,4/23,8x93,6	3831111099631	
019699R	24 DZ	32x76/27x94	32x78,2/27x96,2	3838433000413	
019701R	25 DZ	36x89/32x106	36x91,2/32x108,2	3838433000420	





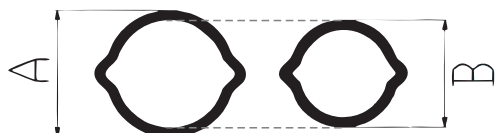







**KOVINSKE CEVI L KOMPL.**  
 ČELIČNE CIJEVI L KOMPL.  
 FÉMCSÖVEK L KOMPL.  
 KOVOVÁ TRUBKA L KOMPL.

ARTIKEL ARTIKAL   CIKK   ARTIKL	OZNAKA OZNAKA   MEGJELÖLÉS   OZNAČENÍ	DOLŽINA DUŽINA   HOSSZÚSÁG   DÉLKA	PROFIL A/B PROFIL A/B   FORMA A/B   PROFIL A/B	EAN 13 ČRTNA KODA EAN 13-KODNA CRTA   EAN 13-KÓD SZÁM   ČÁROVÝ KÓD EAN 13
003353R	21A; 22A kpl	L500	23,5/30	3831111005571
003354R	21A; 22A kpl	L750	23,5/30	3831111005588
003355R	21A; 22A kpl	L1000	23,5/30	3831111005595
003481R	21A; 22A kpl	L1500	23,5/30	3831111006806
003433R	21A; 22A kpl	L2000	23,5/30	3831111006349
003420R	21A; 22A kpl	L3000	23,5/30	3831111006219
003263R	21B; 22B; 23A kpl	L500	34,5/41	3831111004932
003356R	21B; 22B; 23A kpl	L750	34,5/41	3831111005601
003357R	21B; 22B; 23A kpl	L1000	34,5/41	3831111005618
003438R	21B; 22B; 23A kpl	L1500	34,5/41	3831111006394
003439R	21B; 22B; 23A kpl	L2000	34,5/41	3831111006400
003358R	21B; 22B; 23A kpl	L3000	34,5/41	3831111005625
003252R	23B; 24A kpl	L500	39,5/48	3831111004826
003359R	23B; 24A kpl	L750	39,5/48	3831111005632
003253R	23B; 24A kpl	L1000	39,5/48	3831111004833
003445R	23B; 24A kpl	L1500	39,5/48	3831111006455
003446R	23B; 24A kpl	L2000	39,5/48	3831111006462
003360R	23B; 24A kpl	L3000	39,5/48	3831111005649
019394R	24B; 25; 26A kpl	L500	37/47	3831111099365
019395R	24B; 25; 26A kpl	L750	37/47	3831111099372
019396R	24B; 25; 26A kpl	L1000	37/47	3831111099389
019397R	24B; 25; 26A kpl	L1500	37/47	3831111099396



**KOVINSKE CEVI Z/N**  
 ČELIČNE CIJEVI Z/N  
 FÉMCSÖVEK Z/N  
 KOVOVÁ TRUBKA Z/N

ARTIKEL ARTIKAL   CIKK   ARTIKL	OZNAKA OZNAKA   MEGJELÖLÉS   OZNAČENÍ	DOLŽINA DUŽINA   HOSSZÚSÁG   DÉLKA	PROFIL A/B PROFIL A/B   FORMA A/B   PROFIL A/B	EAN 13 ČRTNA KODA EAN 13-KODNA CRTA   EAN 13-KÓD SZÁM   ČÁROVÝ KÓD EAN 13
019398R	24B; 25; 26A kpl	L2000	37/47	3831111099402 
019399R	24B; 25; 26A kpl	L3000	37/47	3831111099419 
003368R	21AN; 22AN	L3000	23,5	3831111005724 
003364R	21AZ; 22AZ	L3000	30	3831111005687 
003376R	21BN; 22BN; 23AN	L3000	34,5	3831111005809 
003372R	21BZ; 22BZ; 23AZ	L3000	41	3831111005762 
003384R	23BN; 24AN	L3000	39,5	3831111005885 
003380R	23BZ; 24AZ	L3000	48	3831111005847 
019393R	24BN; 25N; 26AN	L3000	37	3831111099358 
019388R	24BZ; 25Z; 26AZ	L3000	47	3831111099303 

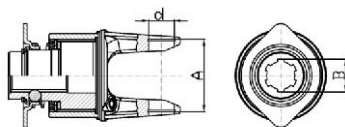

**SKLOPKE**  
SPOJKE  
TENGELYKAPCSOLÓK  
SPOJKY

**PROSTOTEKOČA SKLOPKA PS**  
PROTOČNA SPOJKA PS  
SZABADONFUTÓ KUPLUNG PS  
VOLNOBĚŽNÁ SPOJKA PS

ARTIKEL ARTIKAL   CIKK   ARTIKL	OZNAKA OZNAKA   MEGJELŐLÉS   OZNAČENÍ	PROFIL B PROFIL B   FORMA B   PROFIL B	d	A	EAN 13 ČRTNA KODA EAN 13-KODNA CRTA   EAN 13-KÓD SZÁM   ČÁROVÝ KÓD EAN 13	
019406R	21 PS	1 3/8"z6	22	57	3831111099518	
019407R	21 PS	1 3/8"z21	22	57	3831111099525	
019408R	21 PSL	1 3/8"z6	22	57	3831111099532	
003453R	22 PS	1 3/8"z6	24	64	3831111006530	
019410R	22 PS	1 3/8"z21	24	64	3831111099549	
019411R	22 PSL	1 3/8"z6	24	64	3831111099556	
019412R	23 PS	1 3/8"z6	27	77,4	3831111099563	
019413R	23 PS	1 3/8"z21	27	77,4	3831111099570	
019414R	23 PSL	1 3/8"z6	27	77,4	3831111099587	
003452R	24 PS	1 3/8"z6	32	78,2	3831111006523	
019428R	24 PS	1 3/8"z21	32	78,2	3831111099716	
019415R	24 PSL	1 3/8"z6	32	78,2	3831111099594	

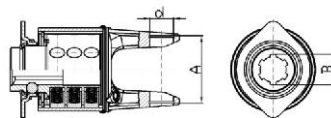

**VARNOSTNA SKLOPKA VS**  
 SIGURNOSNA SPOJKA VS  
 BIZTONSÁGI KUPLUNG VS  
 BEZPEČNOSTNÍ SPOJKA VS

ARTIKEL ARTIKAL   CIKK   ARTIKL	OZNAKA OZNAKA   MEGJELÖLÉS   OZNAČENÍ	PROFIL PROFIL   FORMA   PROFIL	d	A	EAN 13 KÓD EAN 13-KÓDNA CRTA   EAN 13-KÓD SZÁM   ČÁROVÝ KÓD EAN 13	EAN 13 ČRTNA KODA EAN 13-KODNA CRTA   EAN 13-KÓD SZÁM   ČÁROVÝ KÓD EAN 13
019420R	21 VS 300Nm	1 3/8"z6	22	57	3831111099648	
003454R	22 VS 450Nm	1 3/8"z6	24	64	3831111006547	
019421R	22 VS 600Nm	1 3/8"z6	24	64	3831111099655	
019422R	23 VS 600Nm	1 3/8"z6	27	77,4	3831111099662	
019423R	23 VS 900Nm	1 3/8"z6	27	77,4	3831111099679	
019424R	23 VS1 1200Nm	1 3/8"z6	27	77,4	3831111099686	
005390R	24 VS 900Nm	1 3/8"z6	32	78,2	3831111099426	
003455R	24 VS1 1200Nm	1 3/8"z6	32	78,2	3831111014177	
019425R	24 VS1 1500Nm	1 3/8"z6	32	78,2	3831111006554	



NASTAVEK SKLOPKE  
NASTAVAK SPOJNICE  
ÁTALAKITÓ  
NÁSTAVEK SPOJKY

ARTIKEL ARTIKAL   CIKK   ARTIKL	OZNAKA OZNAKA   MEGJELÖLÉS   OZNAČENÍ	PROFIL PROFIL   FORMA   PROFIL	EAN 13-ČRTNA KODA EAN 13-KODNA CRTA   EAN 13-KÓD SZÁM   ČÁROVÝ KÓD EAN 13	
003494R	PS	1 3/8"z6 - 1 3/8"z6	3831111006912	
004974R	VS 600Nm	1 3/8"z6 - 1 3/8"z6	3831111014146	



VARNOSTNI ZATIČI 10 KOS  
SIGURNOSTNI VIJAK 10 KOM  
BIZTONSÁGI CSAPSZEG 10 DB  
ZAJIŠŤOVACÍ KOLÍK 10 KS

ARTIKEL ARTIKAL   CIKK   ARTIKL	OZNAKA OZNAKA   MEGJELÖLÉS   OZNAČENÍ	EAN 13-ČRTNA KODA EAN 13-KODNA CRTA   EAN 13-KÓD SZÁM   ČÁROVÝ KÓD EAN 13	
002679R	Varnostni zatič   Sigurnostni vijak   Biztonsági csapszeg   Zajišťovací kolík	3831111001177	



Handwriting practice sheet with horizontal dotted lines.

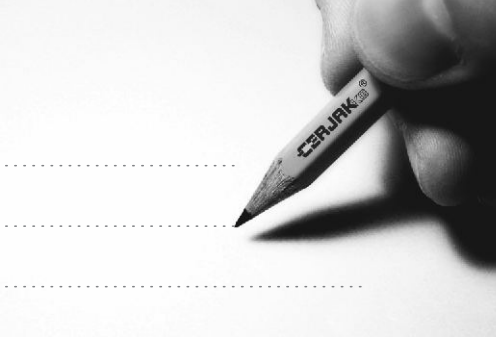

Handwriting practice sheet with horizontal dotted lines.

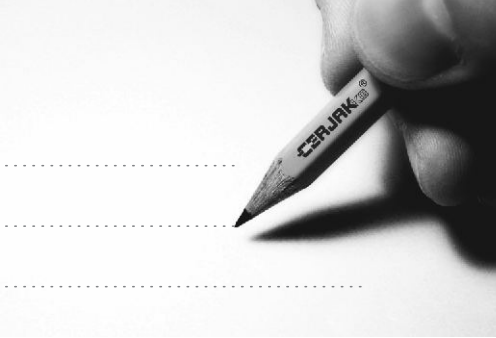





**CERJAK**

Cerjak d.o.o., Žadovinek 38, SI-8273 Leskovec pri Krškem, Slovenija

Tel.: +386 (0)7 49 21 681; +386 (0)7 49 21 682 • Fax: +386 (0)7 49 21 683 • [info@cerjak.si](mailto:info@cerjak.si) • [www.cerjak.si](http://www.cerjak.si)